



**Elemental
Microanalysis**

СОВ ЛАБ
КОМПЛЕКСНОЕ ОСНАЩЕНИЕ
+7(916)414-93-61 www.sov-lab.ru
+7(495)045-58-29 sov_lab@mail.ru



catalogue | A world of products for
MICRO CHNOS & CF-IRMS analysis

Contents

4	Introduction	44	Consumables kits
	Sample encapsulation	46	Liners/inserts/ash fingers/crucibles
6	Pressed tin capsules and pans	48	Operating supplies
10	Smooth tin capsules, tin weighing boats	51	Separation columns
12	Tin foil squares, cones and discs	52	Tools and accessories
14	Pressed silver capsules and pans	54	Oxygen flask combustion equipment
16	Smooth silver capsules; silver boats, squares, discs		
17	Aluminium encapsulation		
20	Nickel encapsulation		
	Reagents	55	Configuration guide for CHNOS
21	Combustion catalysts and reagents	64	Legacy instruments
22	Combustion aids, interference removal reagents		
23	Copper reduction reagents, adsorbent materials, column packings		
24	Pyrolysis catalysts and reagents, scrubbing and purification reagents	70	Additional products for CF-IRMS
25	Miscellaneous materials, gas doping reagents	70	Reagents
	Reference materials	71	Glassy carbon and ceramic tubes
26	Pure chemical reference materials	72	Quartz/glass furnace and scrubbing tubes
28	Natural reference materials	73	Crucibles, inserts and lances
	Quartz, glassware & furnace tubes/accessories	74	Packed tubes
30	Elementar®	75	O-rings and seals, columns and accessories
33	EuroVector	76	Consumables kits, equilibrium reagents, Nafion® dryers
35	LECO®	77	Vials, seals and caps
36	NC Technologies	78	Reference materials for CF-IRMS
37	PerkinElmer®	79	Configuration guide for CF-IRMS
38	Thermo Fisher Scientific®		
	O-rings, seals & caps	86	Cross references
40	Elementar®		
41	EuroVector		
42	LECO®, NC Technologies		
43	PerkinElmer®, Thermo Fisher Scientific®		

The use of OEM names or part numbers is intended for convenience only, and does not imply that the products are of OEM origin unless specified. All Elemental Microanalysis products are guaranteed to be of high quality and are deemed to be suitable alternatives in the stated instruments. All OEM trademarks acknowledged.

Information in this catalogue is correct at time of printing, but may be subject to change. Please refer to our website for the latest information.

Introduction

About the Company

Elemental Microanalysis has grown from small beginnings over 45 years ago as a micro-analytical laboratory to be a leading manufacturer and supplier of consumables, laboratory supplies and other products for elemental analysers. We operate from our purpose-built factory, warehouse and laboratory complex in Devon, UK.

As the leading independent supplier of elemental analysis consumables, we can offer substantial savings in comparison to the prices charged by the original supplier of your instrument. But we know that you need more from a supplier than simply low prices. You need to buy with the confidence that your analysis will not be compromised by poor quality consumables and the knowledge that your supplier has all the resources to provide the full range of support that you expect.

‘Price is what you pay, value is what you get’.

You learn a lot in 45 years – a lot about your products – how to make them and how to use them, a lot about your customers and their needs. We have been developing, refining and using products for elemental analysis since 1976 and have a unique in-depth knowledge of instruments from all manufacturers.

These days we offer the world’s largest range of quality products for elemental analysis, sending our products to customers across the globe. We take great pride in the quality of our products.



All products which we manufacture in-house use our ISO 9001:2015 certified quality system, implemented by our highly trained technicians.

We don't just make CRMs and consumables – we use them every day in our UKAS 17025 accredited analytical laboratory (CHNOS, IRMS and CIC analysis), which affords us constant feedback on proven performance. We do not compromise on quality and don't expect you to either. Our total satisfaction guarantee backs up our commitment to our product quality.

We will always treat our customers with honesty and integrity. If we do make a mistake, we don't try to hide it – we recognise it and put it right. We won't sell you short measure and we won't mislead you in any way. Our business is built on long-term relationships, as our customers will testify – many have been with us for more than 30 years!

Guaranteed quality

Our company's management system is certified to ISO 9001:2015 by LRQA, we have an ISO/IEC 17025:2017 UKAS accredited Testing Laboratory, and we are an ISO/IEC 17034:2016 UKAS accredited Reference Materials Producer. Our confidence in our products allows us to offer you a total satisfaction guarantee: if our product does not perform at least as well as the brand of product you usually use, you can return it for a full refund.



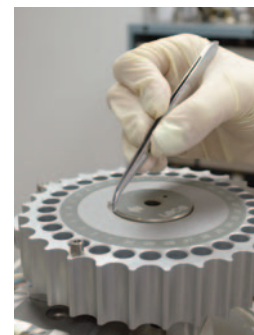
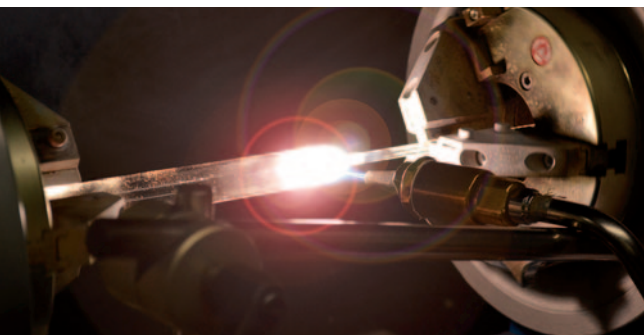

'price is what you pay –
value is what you get'

Technical service

In this catalogue we have tried to provide the most accurate and complete information possible about our ever-expanding range. We realise, however, that you may require additional technical information. For this reason we have technical specialists on hand to answer your questions and advise you on selecting the products best suited to your needs (email enquiries@microanalysis.co.uk). We can also supply samples, and even develop new products for your particular application.

Sales service

Our friendly sales staff will ensure that your order is despatched promptly and correctly. They can tell you about our stock levels, prices, shipping arrangements, or answer any other queries you may have. Most orders are despatched within 24 hours of receipt. Rush orders receive special attention and are processed immediately. If you have an urgent problem or need priority despatch, please let us know.

Try our products – free of charge!

Try before you buy – we have sample packs available for most elemental analysers on the market. Just let us know the instrument you have and we will send you a trial quantity of 3 or 4 different consumables to try – free and with no obligation. Offer limited to one per customer.

Expanding offerings

We are constantly working on improving our products and these improvements may mean that some products differ from the descriptions in this catalogue. Our technical staff are happy to discuss any improvements made, and the resulting benefits. To keep up-to-date with the latest products and developments, visit our website (elementalmicroanalysis.com), join our mailing list for updates delivered straight to your inbox (sign up on our website), or check in on your schedule by following us on LinkedIn or Twitter (@elementallab).

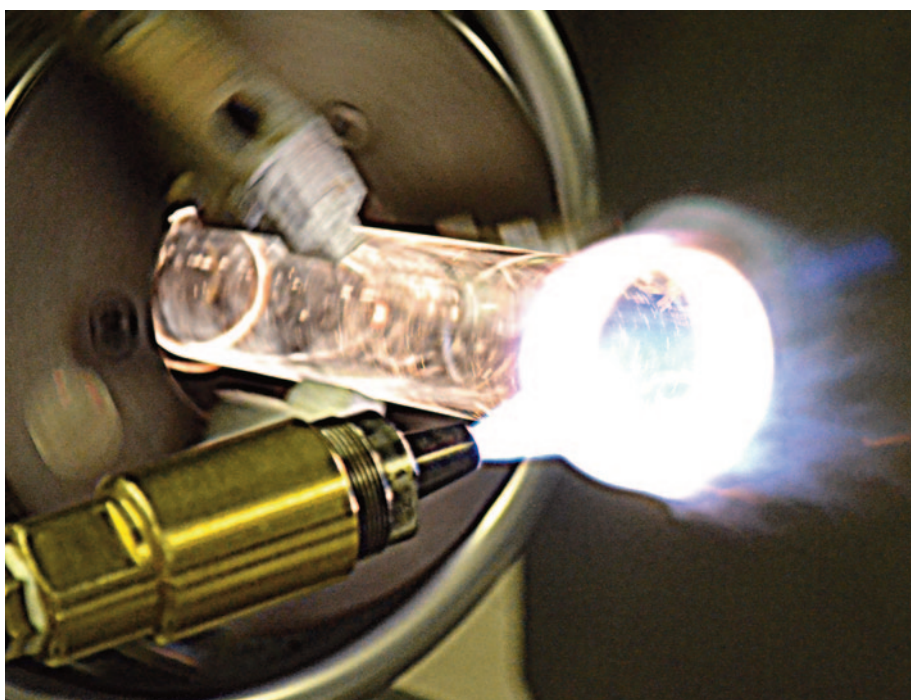

Sample encapsulation

Pressed tin capsules for solid samples

Elemental Microanalysis pressed capsules for solid samples are available in standard and ultra-light weights. They are manufactured to exacting standards ensuring consistently low blank values and uniform weight.

They can be used without any cleaning pre-treatment, but for critical samples solvent cleaning is recommended. They should not be ultrasonically cleaned as damage may result. We also offer ultra-clean capsules, which are solvent washed after pressing, in certain sizes of both standard and ultra-light weight capsules.



Standard weight pressed tin capsules

Pressed tin capsules for routine use.



Diameter/mm	Height/mm	Volume/ μ l <i>(calculated)</i>	Weight/mg <i>(approx average)</i>	Pack	Part No
2	4.5	14	8	100	D1083
3.2	4	32	8	100	D1001
3.2	4	32	8	250	D1043
3.2	4	32	8	500	D1000
3.2	5.25	42	12	100	D1109
3.2	5.25	42	12	250	D1004
3.2	6.5	52	17	100	D1086
3.5	3.75	36	8	100	D1087
3.5	5	48	12	100	D1003
3.5	5	48	12	250	D1005
3.5	5	48	12	500	D1002
3.5	6.25	60	17	100	D1088
3.5	8.75	84	30	100	D1089
4	4.75	60	12	100	D1090
4	6	75	17	100	D1007
4	6	75	17	250	D1038
4	6	75	17	500	D1006
4	8.5	107	30	100	D1091
5	5.5	108	17	100	D1092
5	8	157	30	100	D1009
5	8	157	30	200	D1042
5	8	157	30	250	D1008
5	9	177	36	100	D1023
5	9	177	36	200	D1026
5	9	177	36	250	D1021
5	9	177	36	400	D1022
5	12.5	245	62	200	D1010
6	7.5	212	30	100	D1093
6	12	339	62	200	D1012
6	14	396	82	200	D1017
7	7	269	30	100	D5047
7	11.5	443	62	100	D1102
8	11	553	62	100	D1103
8	13.5	679	82	200	D1018
8	20	1005	160	100	D1011
9	10.5	668	62	100	D1104
10	10	785	62	50	D5101
10	10	785	62	100	D5055

Guide by actual size



2–3.2mm diameter capsules

				
Std weight	D1083	D1001 D1043 D1000	D1109 D1004	D1086
Ultra-light	D1084	D1014	D1108	D1094

3.5mm diameter capsules

				
Std weight	D1087	D1003 D1005 D1002	D1088	D1089
Ultra-light	D1095	D1015	D1096	D1097

4mm diameter capsules

			
Std weight	D1090	D1007 D1038 D1006	D1091
Ultra-clean std weight		D1027 D1028 D1112	
Ultra-light	D1098	D1016	D1099
Ultra-clean ultra-light		D1030 D1035 D1110	

We can manufacture capsules in sizes and materials other than those listed here. We also offer discounts for larger order quantities. Please email enquiries@microanalysis.co.uk with your requirements.

Sample encapsulation

Pressed tin capsules for solid samples (continued)

Guide by actual size

5 mm diameter capsules

Std weight	D1092	D1009 D1042 D1008	D1023 D1026 D1021 D1022	D1010
Ultra-clean, std weight		D1029 D1034 D1113		
Ultra-light	D1100	D1013 D1019	D1024 D1025	D1032
Ultra-clean, ultra-light		D1031 D1036 D1111		

6 mm diameter capsules

Std weight	D1093	D1012	D1017
Ultra-clean std weight		D1041 D1040	
Ultra-light	D1101	D1033	

7 mm diameter capsules

Std weight	D5047	D1102
Ultra-clean std weight	D1037 D1114	
Ultra-light	D5208	D1105

8 mm diameter capsules

Std weight	D1103	D1018	D1011
Ultra-light	D1106		

9–10 mm diameter capsules

Std weight	D1104	D5101 D5055
Ultra-light	D1107	D5216

Ultra-clean standard weight pressed tin capsules

Ultra-clean capsules are solvent-washed in acetone to ensure the removal of any surface contamination. *These products are sold in a multiwell plate.

Diameter/mm	Height/mm	Volume/ μ l <i>(calculated)</i>	Weight/mg <i>(approx average)</i>	Pack	Part No
4	6	75	17	96	D1027 *
4	6	75	17	250	D1028
4	6	75	17	10 x 96	D1112 *
5	8	157	30	96	D1029 *
5	8	157	30	250	D1034
5	8	157	30	10 x 96	D1113 *
6	7.5	212	30	96	D1041 *
6	7.5	212	30	10 x 96	D1040 *
7	7	269	30	48	D1037 *
7	7	269	30	10 x 48	D1114 *

Ultra-light weight pressed tin capsules

A range of ultra-light weight tin capsules weighing 40% less than the standard range. These lighter capsules produce less ash build-up in combustion tubes, and have lower blank values.

Diameter/mm	Height/mm	Volume/ μ l <i>(calculated)</i>	Weight/mg <i>(approx average)</i>	Pack	Part No
2	4.5	14	5	100	D1084
3.2	4	32	5	100	D1014
3.2	5.25	42	8	100	D1108
3.2	6.5	52	11	100	D1094
3.5	3.75	36	5	100	D1095
3.5	5	48	8	100	D1015
3.5	6.25	60	11	100	D1096
3.5	8.75	84	19	100	D1097
4	4.75	60	11	100	D1098
4	6	75	11	100	D1016
4	8.5	107	19	100	D1099
5	5.5	108	11	100	D1100
5	8	157	19	100	D1013
5	8	157	19	1000	D1019
5	9	177	24	100	D1024
5	9	177	24	250	D1025
5	12.5	245	39	100	D1032
6	7.5	212	19	100	D1101
6	12	339	39	100	D1033
7	7	269	19	100	D5208
7	11.5	443	39	100	D1105
8	11	553	39	100	D1106
9	10.5	668	39	100	D1107
10	10	785	39	100	D5216

Ultra-clean ultra-light weight pressed tin capsules

Ultra-light weight tin capsules weighing 40% less than the standard range; solvent-washed in acetone to ensure removal of surface contamination. *Sold in a multiwell plate.

Diameter/mm	Height/mm	Volume/ μ l <i>(calculated)</i>	Weight/mg <i>(approx average)</i>	Pack	Part No
4	6	75	11	96	D1030 *
4	6	75	11	100	D1035
4	6	75	11	10 x 96	D1110 *
5	8	157	19	96	D1031 *
5	8	157	19	100	D1036
5	8	157	19	10 x 96	D1111 *

Sample encapsulation

Pressed tin pans for solid samples

Elemental Microanalysis pressed pans for solid samples are available in standard and ultra-light weights. They are manufactured to exacting standards ensuring consistently low blank values and uniform weight.

They can be used without any cleaning pre-treatment, but for critical samples solvent cleaning is recommended. They should not be ultrasonically cleaned as damage may result.



D5101

Standard weight pressed tin pans

Pressed tin pans for routine use.

Diameter/mm	Height/mm	Volume/ μ l <i>(calculated)</i>	Weight/mg <i>(approx average)</i>	Pack	Part No
4	3.5	44	8	100	D5040
5	3	59	8	100	D5041
5	4.25	83	12	100	D5042
5	4.25	83	12	500	D5150
6	2.5	71	8	100	D5003
6	3.75	106	12	100	D5043
6	5	141	17	100	D5044
7	3.25	125	12	100	D5045
7	4.5	173	17	100	D5046
7	7	269	30	100	D5047
8	2.75	138	12	100	D5048
8	4	201	17	100	D5049
8	6.5	327	30	100	D5050
9	3.5	223	17	100	D5051
9	6	382	30	100	D5052
9	6	382	30	500	D5152
10	3	236	17	100	D5053
10	5.5	432	30	100	D5054
10	10	785	62	50	D5101
10	10	785	62	100	D5055
12.5	4.25	522	30	100	D5056
12.5	8.75	1074	62	100	D5057
15	7.5	1325	62	100	D5059
20	5	1571	62	100	D5060

Ultra-clean standard weight pressed tin pans

Ultra-clean tin pans are solvent-washed in acetone to ensure the removal of any surface contamination. *These products are sold in a multiwell plate.

Diameter/mm	Height/mm	Volume/ μ l <i>(calculated)</i>	Weight/mg <i>(approx average)</i>	Pack	Part No
7	7	269	30	48	D1037 *
7	7	269	30	10 x 48	D1114 *

Guide by actual size



4–5 mm diameter pans

			
Std weight	D5040	D5041	D5042 D5150
Ultra-light	D5200	D5201	D5202
Ultra-clean ultra-light	D5222		

6 mm diameter pans

			
Std weight	D5003	D5043	D5044
Ultra-light	D5203	D5204	D5205

7 mm diameter pans

			
Std weight	D5045	D5046	D5047
Ultra-clean std weight			D1037 D1114
Ultra-light	D5206	D5207	D5208

8 mm diameter pans

			
Std weight	D5048	D5049	D5050
Ultra-light	D5209	D5210	D5211

Do you want to find a product using the manufacturer part number?
Try our cross-reference list on p 86 or use the OEM Search tool on our website.

Sample encapsulation

Pressed tin pans for solid samples (continued)

Guide by actual size

9 mm diameter pans

		
Std weight	D5051	D5052 D5152
Ultra-light	D5212	D5213

10 mm diameter pans

			
Std weight	D5053	D5054	D5101 D5055
Ultra-light	D5214	D5215	D5216

12.5 mm diameter pans

		
Std weight	D5056	D5057
Ultra-light	D5217	D5218

15–20 mm diameter pans

		
Std weight	D5059	D5060
Ultra-light	D5220	D5221

Ultra-light weight pressed tin pans

Ultra-light pressed tin pans weigh 40% less than the standard range. These lighter pans produce less ash build-up in combustion tubes, and have lower blank values.

Diameter/mm	Height/mm	Volume/ μ l <i>(calculated)</i>	Weight/mg <i>(approx average)</i>	Pack	Part No
4	3.5	44	5	100	D5200
5	3	59	5	100	D5201
5	4.25	83	8	100	D5202
6	2.5	71	5	100	D5203
6	3.75	106	8	100	D5204
6	5	141	11	100	D5205
7	3.25	125	8	100	D5206
7	4.5	173	11	100	D5207
7	7	269	19	100	D5208
8	2.75	138	8	100	D5209
8	4	201	11	100	D5210
8	6.5	327	19	100	D5211
9	3.5	223	11	100	D5212
9	6	382	19	100	D5213
10	3	236	11	100	D5214
10	5.5	432	19	100	D5215
10	10	785	39	100	D5216
12.5	4.25	522	19	100	D5217
12.5	8.75	1074	39	100	D5218
15	7.5	1325	39	100	D5220
20	5	1571	39	100	D5221

Ultra-clean ultra-light weight pressed tin pans

Ultra-clean, ultra-light pressed tin pans weigh 40% less than standard ones, and are solvent-washed in acetone to ensure the removal of any surface contamination.

Diameter/mm	Height/mm	Volume/ μ l <i>(calculated)</i>	Weight/mg <i>(approx average)</i>	Pack	Part No
4	3.5	44	5	100	D5222



D5208

Sample encapsulation

Smooth tin capsules for liquid samples

Elemental Microanalysis smooth wall tin capsules for liquid samples are extruded to exacting standards to ensure consistently low blank values, high quality fabrication and low weight. Smooth wall capsules can be used without any cleaning pre-treatment, but we recommend solvent cleaning for critical work.

The capsules can be sealed using a proprietary sealing tool (F5109), or mole grips (E2043), available from our microanalytical tools and accessories section (see p 53).

Flat base smooth wall tin capsules

Diameter/mm	Height/mm	Volume/ μ l <i>(calculated)</i>	Weight/mg <i>(approx average)</i>	Pack	Part No
1.06	5.5	5	8	50	D4107
2	3.5	11	19	100	D4040
2	4	13	21	100	D4041
2	4.5	14	23	100	D4019
2	5	16	25	50	D4004
2	5	16	25	100	D4042
2	5.5	17	27	100	D4000
3	3.5	25	31	100	D4025
3	4	28	34	100	D4043
3	4.5	32	38	100	D4044
3	5	35	41	100	D4045
3	5.5	39	45	100	D4046
3	6	42	52	100	D4001
3	6	42	52	250	D4131
3	7	49	54	100	D4020
3	8	57	65	100	D4021
3.5	4	38	42	100	D4032
3.5	4.5	43	46	100	D4047
3.5	5	48	51	100	D4048
3.5	5.5	53	55	100	D4033
3.5	6	58	72	100	D4049
3.5	7	67	66	100	D4034
3.5	8	77	75	100	D4050
3.5	9	87	84	100	D4035
3.5	9	87	84	250	D4132
4.75	11	195	155	250	D4121
5	5	98	76	100	D4051
5	5.5	108	82	100	D4052
5	6	118	88	100	D4054
5	7	137	98	100	D4036
5	8	157	90	100	D4057
5	9	177	122	100	D4059
5	10	196	134	100	D4037
5	12	236	157	100	D4038
5	18	353	222	100	D4039
6	6	170	153	100	D4084
6	7	198	172	100	D4085
6	8	226	191	100	D4086
6	9	254	210	100	D4087
6	10	283	229	100	D4088
6	12	339	266	100	D4089
6	18	509	290	100	D4090
6.75	14	501	305	100	D4120
8	8	402	219	100	D4091
8	9	452	237	100	D4092
8	10	503	320	100	D4093
8	12	603	292	100	D4094
8	18	905	401	100	D4095
8	20	1005	438	100	D4096

Guide by actual size

1–2 mm diameter capsules

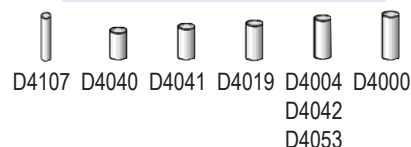

3 mm diameter capsules

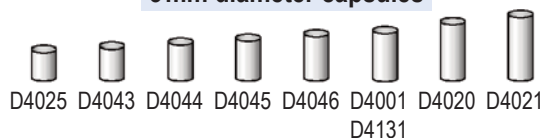

3.5 mm diameter capsules



5 mm diameter capsules

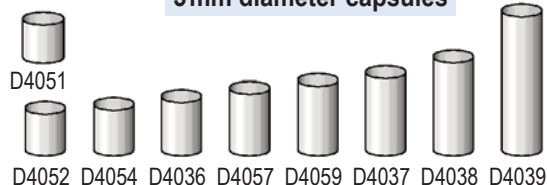

6 mm diameter capsules

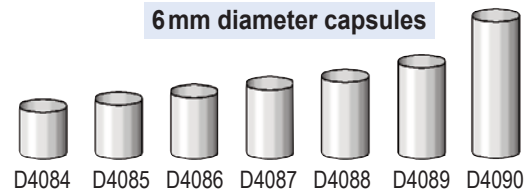

8 mm diameter capsules

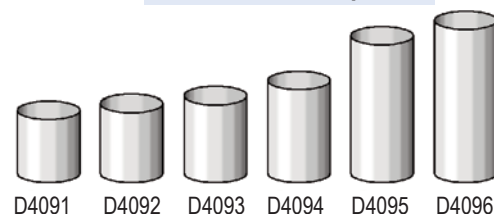

Sample encapsulation

Smooth tin capsules for liquid samples (continued)

Guide by actual size

5mm diameter capsules

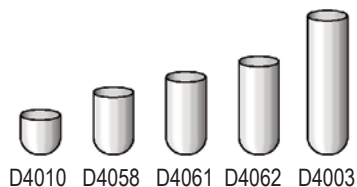

6mm diameter capsules

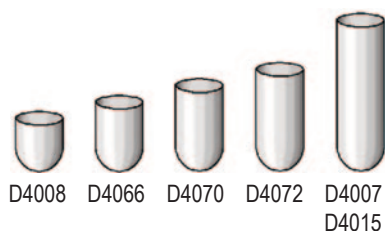

8mm diameter capsules

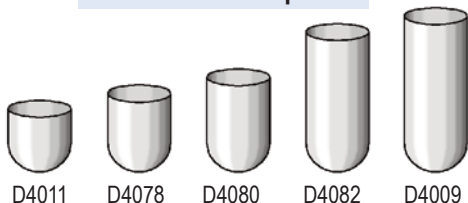

Round base smooth wall tin capsules

Diameter/mm	Height/mm	Volume/ μ l <i>(calculated)</i>	Weight/mg <i>(approx average)</i>	Pack	Part No
5	5	82	96	100	D4010
5	8	141	130	100	D4058
5	10	180	153	100	D4061
5	12	219	176	100	D4062
5	18	337	245	100	D4003
6	6	141	126	100	D4008
6	8	198	153	100	D4066
6	10	254	181	100	D4070
6	12	311	208	100	D4072
6	18	481	290	100	D4007
6	18	481	290	1000	D4015
8	8	335	224	100	D4011
8	10	436	260	100	D4078
8	12	536	297	100	D4080
8	18	838	406	100	D4082
8	20	938	443	100	D4009



Tin weighing boats for solid and liquid samples

Tin weighing boats

Pressed tin boats or smooth wall tin boats, with or without a handling tab, are available.

Length/mm	Width/mm	Height/mm	Thickness/mm	Volume/ μ l <i>(calculated)</i>	Weight/mg <i>(approx average)</i>	Pack	Part No
6	4	4	0.02	96	14	200	D5028
6	4	4	0.02	96	14	1000	D5029
9	4	2.5	0.1	90	56	100	D5009
12	4	2.7	0.1	129	64	100	D5113
12	4	4	0.0125	192	21	100	D5022
12	4	4	0.0125	192	21	1000	D5130
12	4	4	0.02	192	36	1000	D5140
12	6	6	0.0125	432	38	100	D5023
12	6	6	0.0125	432	60	500	D5131
15	8	8	0.02	960	100	250	D5032
20	10	9	0.02	1800	175	120	D5033



Guide by actual size

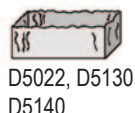

Sample encapsulation

Tin foil squares for fibrous or sticky samples

Elemental Microanalysis metal foil squares are ideal for the encapsulation of sticky, fibrous or other samples which are difficult to handle using conventional pressed capsules. A small dab or a few fibres on a disc or square can be easily encapsulated by folding the foil around the sample, and a manual sample press can be used to produce a compressed pellet. With a little practice even glass fibre filters can be rolled up in foil to form neat cylinders which fit the instrument carousel.

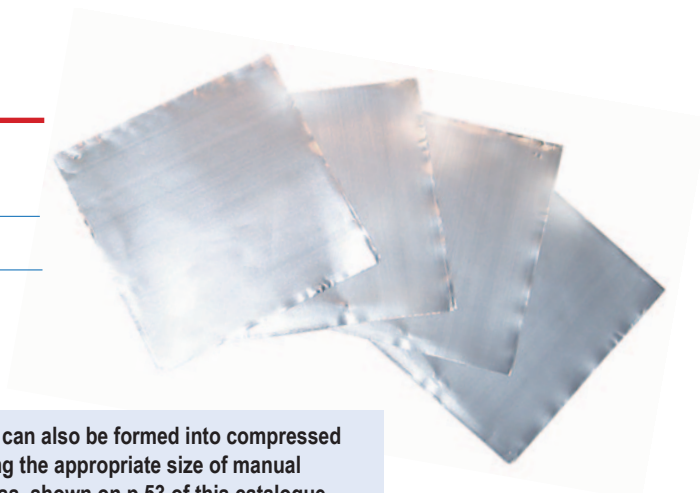

These foils can also be formed into compressed pellets using the appropriate size of manual sample press, shown on p 53 of this catalogue.

Standard weight tin foil squares

Standard weight tin foil squares, manufactured from high quality tin. Suitable for routine use.

Size/mm	Thickness/mm	Weight/mg <i>(approx average)</i>	Pack	Part No
22 x 22	0.0125	44	100	D1062
30 x 30	0.0125	82	100	D1067
37 x 37	0.0125	125	100	D1068
37 x 37	0.0125	125	400	D1116
43 x 43	0.0125	168	100	D1085
50 x 50	0.0125	225	100	D1115
50 x 50	0.0125	225	500	D1118
50 x 50	0.0125	225	1500	D1119

Ultra-light weight tin foil squares

Tin foil squares weighing approximately 40% less than the standard range.

Size/mm	Thickness/mm	Weight/mg <i>(approx average)</i>	Pack	Part No
22 x 22	0.008	28	100	D1080
30 x 30	0.008	52	100	D1081
37 x 37	0.008	80	100	D1082

Guide by actual size

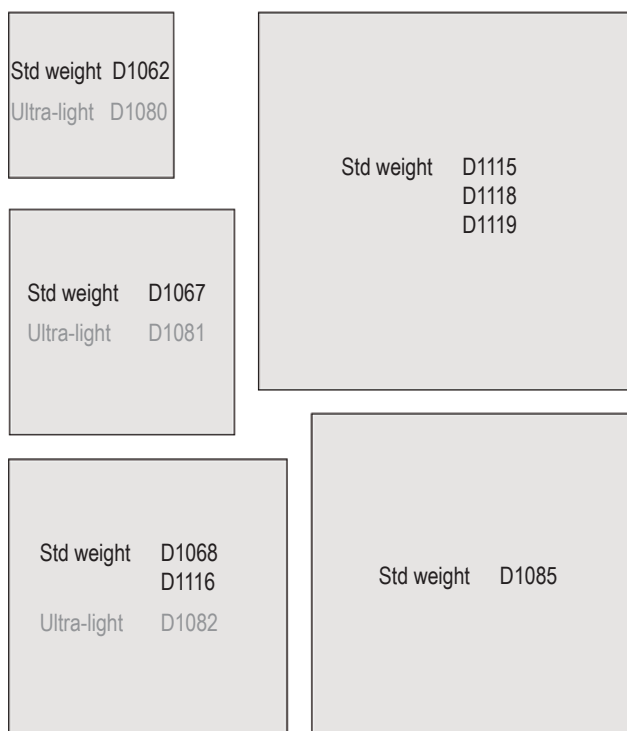

Std weight D1062
Ultra-light D1080

Std weight D1067
Ultra-light D1081

Std weight D1068
D1116
Ultra-light D1082

Std weight D1115
D1118
D1119

Std weight D1085

Tin foil cones

Our tin foil cones are pre-formed from tin foil squares and offer great labour savings.

Weight/mg <i>(approx average)</i>	Foil size/mm	Pack	Part No
125	37 x 37	100	D9001
125	37 x 37	1500	D9010
225	50 x 50	100	D9002
225	50 x 50	400	D9003



Tin foil evaporating cups

Ideal for drying liquid samples down to residue prior to feeding into an analyser. The shape has been designed so that the residue forms in the bottom of the cup, and allows easy folding.

Diameter/mm	Height/mm	Volume/ml <i>(calculated)</i>	Weight/mg <i>(approx average)</i>	Pack	Part No
24	28	5	390	48	D8012



Sample encapsulation

Tin foil discs for fibrous or sticky samples

Elemental Microanalysis metal foil discs are ideal for the encapsulation of sticky, fibrous or other samples which are difficult to handle using conventional pressed A small dab or a few fibres on a disc or square can be easily encapsulated by folding the foil around the sample, and a manual sample press can be used to produce a compressed pellet. With a little practice even glass fibre filters can be rolled up in foil to form neat cylinders which fit the instrument carousel.



Guide by actual size

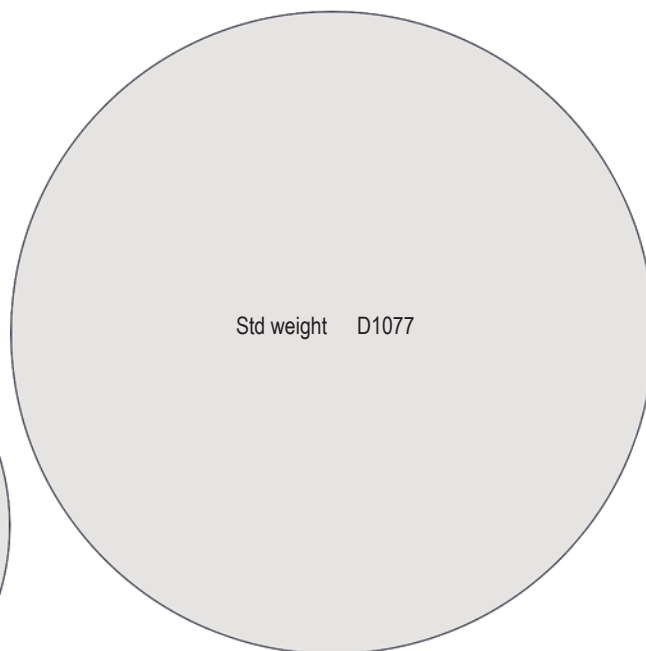
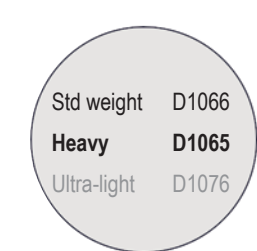

Standard weight tin foil discs

Manufactured from high purity tin. Suitable for routine use.

Diameter/mm	Thickness/mm	Weight/mg <i>(approx average)</i>	Pack	Part No
11	0.0125	8	100	D1060
13.5	0.0125	12	100	D1061
16	0.0125	17	100	D1063
21	0.0125	30	100	D1064
30	0.0125	62	100	D1066
34	0.0125	82	100	D1059
35	0.0125	87	100	D1078
62	0.0125	271	100	D1079
85	0.0125	510	100	D1077

Heavy weight tin foil discs

Tin foil disc weighing approximately 60% more than the standard range.

Diameter/mm	Thickness/mm	Weight/mg <i>(approx average)</i>	Pack	Part No
30	0.02	100	100	D1065

Ultra-light weight tin foil discs

Tin foil discs weighing approximately 40% less than the standard range.

Diameter/mm	Thickness/mm	Weight/mg <i>(approx average)</i>	Pack	Part No
11	0.008	5	100	D1070
13.5	0.008	8	100	D1071
16	0.008	11	100	D1073
21	0.008	19	100	D1074
30	0.008	39	100	D1076

These foils can also be formed into compressed pellets using the appropriate size of manual sample press, shown on p 53.

Sample encapsulation

Pressed silver capsules for solid samples

Elemental Microanalysis pressed silver capsules and pans for solid samples are available in standard and ultra-light weights, and are manufactured to ensure consistently low blank values and uniform weight. We also offer ultra-clean standard weight silver capsules in certain sizes.

Silver is usually used to encapsulate samples for oxygen determinations, or when acidifying samples in an open capsule to remove inorganic carbon. In the latter case, after acidification and drying, many users then enclose the sample in a tin

capsule to seal in the surface residual acid and ensure the sample does not spill.

Silver capsules or pans may become slightly oxidised or tarnished due to oxygen and contaminants in the air. This can easily be removed by heating to 375° C in air for one hour prior to use. They should be stored long term under an inert gas.

Standard weight pressed silver capsules

For routine use.

Diameter/mm	Height/mm	Volume/ μ l <i>(calculated)</i>	Weight/mg <i>(approx average)</i>	Pack	Part No
2	4.5	14	15	100	D2083
2	4.5	14	15	500	D2183
3.2	4	32	15	100	D2001
3.2	4	32	15	500	D2000
3.2	5.25	42	22	100	D2085
3.2	6.5	52	31	100	D2086
3.5	3.75	36	15	100	D2087
3.5	5	48	22	100	D2003
3.5	5	48	22	500	D2002
3.5	6.25	60	31	100	D2088
3.5	8.75	84	54	100	D2089
4	4.75	60	22	100	D2090
4	6	75	31	100	D2007
4	6	75	31	500	D2006
4	8.5	107	54	100	D2091
5	5.5	108	31	100	D2092
5	8	157	54	100	D2009
5	8	157	54	250	D2008
5	9	177	62	100	D2015
5	9	177	62	250	D2014
5	12.5	245	110	200	D2010
6	7.5	212	54	100	D2093
6	12	339	110	200	D2012
7	7	269	54	100	D5069
7	11.5	443	110	100	D2102
8	11	553	110	100	D2103
9	10.5	668	110	100	D2104
10	10	785	110	100	D5076

Ultra-clean standard weight pressed silver capsules

Ultra-clean capsules are washed in acetone to remove any surface contamination.

*These products are sold in a multiwell plate.



Diameter/mm	Height/mm	Volume/ μ l <i>(calculated)</i>	Weight/mg <i>(approx average)</i>	Pack	Part No
4	6	75	31	96	D2027 *
4	6	75	31	250	D2028
5	8	157	54	96	D2029 *
5	8	157	54	250	D2030
6	12	339	110	200	D2013

6–7 mm diameter capsules





				
Std weight	D2093	D2012	D5069	D2102
Ultra-clean std weight		D2013		

Guide by actual size



2–3.2 mm diameter capsules

				
Std weight	D2083 D2183	D2001 D2000	D2085	D2086
Ultra-light		D2300 D2301		





3.5 mm diameter capsules

				
Std weight	D2087	D2003 D2002	D2088	D2089
Ultra-light		D2303 D2316 D2302		

4 mm diameter capsules

			
Std weight	D2090	D2007 D2006	D2091
Ultra-clean std weight		D2027 D2028	
Ultra-light		D2307 D2313 D2306 D2019	

5 mm diameter capsules

				
Std weight	D2092	D2009 D2008	D2015 D2014	D2010
Ultra-clean, std weight		D2029 D2030		
Ultra-light		D2309 D2308	D2315 D2314	D2310

8–10 mm diameter capsules

			
Std weight	D2103	D2104	D5076
Ultra-light	D2311	D2312	

Sample encapsulation

Pressed silver capsules for solid samples *(continued)*



Silver capsules or pans may become slightly oxidised or tarnished due to oxygen and contaminants in the air. This can easily be removed by heating to 375° C in air for one hour prior to use. They should be stored long term under an inert gas.

Ultra-light weight pressed silver capsules

Silver does not combust in a furnace like tin does, but melts, forming a pool in the ash crucible. Using light weight silver capsules, if possible, will result in less residual silver.

Diameter/mm	Height/mm	Volume/ μ l <i>(calculated)</i>	Weight/mg <i>(approx average)</i>	Pack	Part No
3.2	4	32	10	500	D2300
3.2	4	32	10	100	D2301
3.5	5	48	11	100	D2303
3.5	5	48	11	250	D2316
3.5	5	48	11	500	D2302
4	6	75	17	100	D2307
4	6	75	17	250	D2313
4	6	75	17	500	D2306
4	6	75	17	1000	D2019
5	8	157	38	100	D2309
5	8	157	38	250	D2308
5	9	177	43	100	D2315
5	9	177	43	250	D2314
5	12.5	245	70	100	D2310
8	11	553	70	100	D2311
9	10.5	668	70	100	D2312

Pressed silver pans for solid samples

Guide by actual size

4–5 mm diameter pans



6 mm diameter pans



7 mm diameter pans



8 mm diameter pans



9 mm diameter pans



10 mm diameter pans



12.5 mm diameter pans



15–20 mm diameter pans

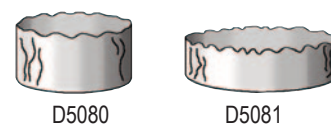

Pressed silver pans made from standard weight silver foil, for routine use.

Diameter/mm	Height/mm	Volume/ μ l <i>(calculated)</i>	Weight/mg <i>(approx average)</i>	Pack	Part No
4	3.5	44	15	100	D5061
5	3	59	15	100	D5062
5	4.25	83	22	100	D5064
6	2.5	71	15	100	D5002
6	3.75	106	22	100	D5065
6	5	141	31	100	D5066
7	3.25	125	22	100	D5067
7	4.5	173	31	100	D5068
7	7	269	54	100	D5069
8	2.75	138	22	100	D5070
8	4	201	31	100	D5071
8	6.5	327	54	100	D5015
9	3.5	223	31	100	D5072
9	6	382	54	100	D5073
10	3	236	31	100	D5074
10	5.5	432	54	100	D5075
10	10	785	110	100	D5076
12.5	4.25	522	54	100	D5077
12.5	8.75	1074	110	100	D5078
15	7.5	1325	110	100	D5080
20	5	1571	110	100	D5081

Sample encapsulation

Smooth wall silver capsules for liquid samples

Smooth walled capsules containing liquid samples can be sealed using our sealing device for liquid samples, F5109, shown on p 53.

Diameter/mm	Height/mm	Volume/ μ l <i>(calculated)</i>	Weight/mg <i>(approx average)</i>	Pack	Part No
2	5	15	34	250	D4103
2	5	15	34	50	D4106
3.5	4	33	90	250	D4104
3.5	5.5	47	113	250	D4102
3.5	9	81	137	100	D4101
3.5	9	81	137	250	D4109



Silver encapsulation products may become slightly oxidised or tarnished due to oxygen and contaminants in the air. This can easily be removed by heating to 375° C in air for one hour prior to use. They should be stored long term under an inert gas.

Silver weighing boats for solid and liquid samples

Length/mm	Width/mm	Height/mm	Thickness/mm	Volume/ μ l <i>(calculated)</i>	Weight/mg <i>(approx average)</i>	Pack	Part No
6	4	4	0.015	96	24	500	D5127
9 + tab	4	2.5	0.015	90	19	100	D5008
12	4	2.7	0.015	129	15	100	D5112
12	4	4	0.015	192	36	100	D5024
12	4	4	0.015	192	36	500	D5039
12	6	6	0.015	432	66	100	D5026
15	8	8	0.015	960	147	70	D5034
20	10	9	0.015	1800	190	42	D5035

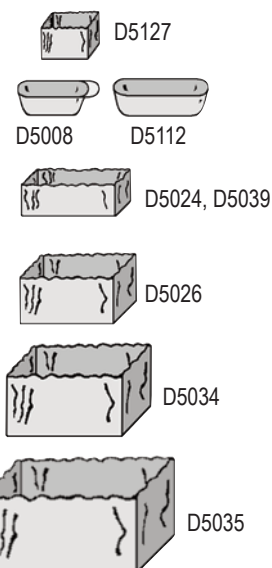

Silver foil squares for fibrous or sticky samples

Manufactured from high purity silver foil. Suitable for routine use.

Size/mm	Thickness/mm	Weight/mg <i>(approx average)</i>	Pack	Part No
15 x 15	0.015	35	100	D2080
20 x 20	0.015	63	100	D2081
25 x 25	0.015	98	100	D2082
35 x 35	0.015	192	100	D2084

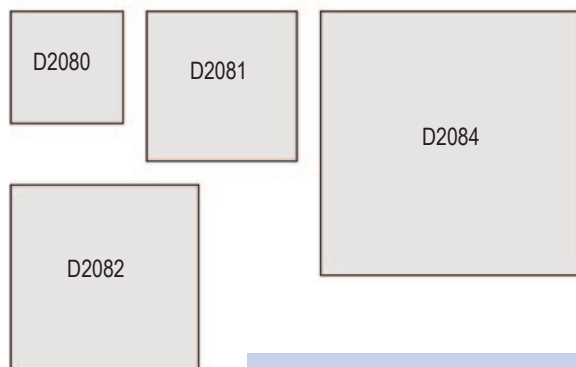

These foils can also be formed into compressed pellets using the appropriate size of manual sample press, shown on p 53 of this catalogue.

Silver foil discs for fibrous or sticky samples

Manufactured from high purity silver foil. Suitable for routine use.

Diameter/mm	Thickness/mm	Weight/mg <i>(approx average)</i>	Pack	Part No
11	0.015	15	100	D2060
13.5	0.015	22	100	D2061
16	0.015	31	100	D2063
21	0.015	54	100	D2064
30	0.015	110	100	D2066

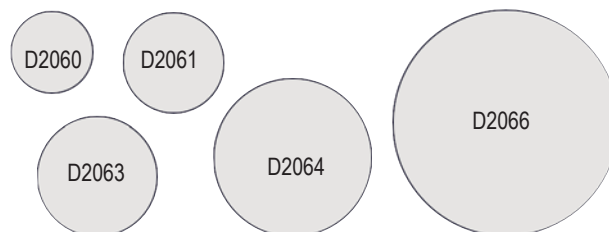

Sample encapsulation

Pressed aluminium capsules for solid samples



D3004

Elemental Microanalysis pressed aluminium capsules for solid samples are available in standard weight, and ultra-clean standard weight. They are manufactured to exacting standards ensuring consistently low blank values and uniform weight.

Aluminium capsules can be used in place of tin for certain applications. Since aluminium does not combust as tin does, they are not typically used for routine analyses. While solvent rinsing may remove surface traces, aluminium capsules can be pre-combusted at 550°C to remove contaminants, so are particularly recommended for low level C and N analysis.

Standard weight pressed aluminium capsules

Pressed aluminium capsules for routine use.

Diameter/mm	Height/mm	Volume/ μ l <i>(calculated)</i>	Weight/mg <i>(approx average)</i>	Pack	Part No
2	4.5	14	4	100	D3083
3.2	4	32	4	500	D3000
3.2	5.25	42	6	100	D3085
3.2	6.5	52	8	100	D3086
3.5	3.75	36	4	100	D3087
3.5	5	48	6	500	D3001
3.5	6.25	60	8	100	D3088
3.5	8.75	84	14	100	D3089
4	4.75	60	6	100	D3090
4	6	75	8	500	D3003
4	8.5	107	14	100	D3091
5	5.5	108	8	100	D3092
5	8	157	14	250	D3004
5	9	177	19	250	D3007
5	12.5	245	27	200	D3005
6	7.5	212	14	100	D3093
6	12	339	27	200	D3006
7	7	269	14	100	D5089
7	11.5	443	27	100	D3102
8	11	553	27	100	D3103
9	10.5	668	27	100	D3104
10	10	785	28	100	D5097

Ultra-clean pressed aluminium capsules

*These products are sold in a multiwell plate.

Diameter/mm	Height/mm	Volume/ μ l <i>(calculated)</i>	Weight/mg <i>(approx average)</i>	Pack	Part No
4	6	75	8	96	D3027 *
4	6	75	8	250	D3028
5	8	157	14	96	D3029 *
5	8	157	14	250	D3030

Guide by actual size

2–3.2 mm diameter capsules

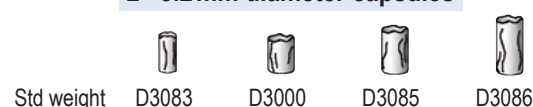

3.5 mm diameter capsules

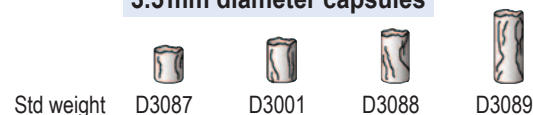

4 mm diameter capsules

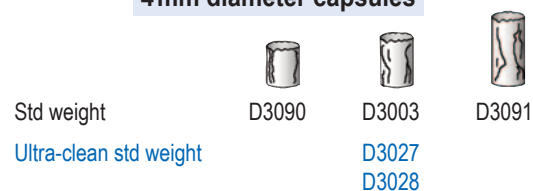

5 mm diameter capsules



6 mm diameter capsules



7–8 mm diameter capsules



9–10 mm diameter capsules



Sample encapsulation

Pressed aluminium pans

Elemental Microanalysis pressed aluminium pans for solid samples are available in standard and heavy weights. They are manufactured to exacting standards, ensuring consistently low blank values and uniform weight.



D5083

Pressed aluminium pans

Diameter/mm	Height/mm	Volume/ μ l <i>(calculated)</i>	Weight/mg <i>(approx average)</i>	Pack	Part No
4	3.5	44	4	100	D5082
5	3	59	4	100	D5083
5	4.25	83	6	100	D5084
6	2.5	71	5	100	D5000
6	3.75	106	8	100	D5085
6	5	141	8	100	D5086
7	3.25	125	6	100	D5087
7	4.5	173	8	100	D5088
7	7	269	14	100	D5089
8	2.75	138	6	100	D5090
8	4	201	8	100	D5091
8	5.5	276	55	100	D8601
8	6.5	327	14	100	D5092
9	3.5	223	8	100	D5093
9	6	382	14	100	D5094
10	3	236	8	100	D5095
10	5.5	432	14	100	D5096
10	10	785	28	100	D5097
12.5	4.25	522	14	100	D5098
12.5	8.75	1074	28	100	D5099
15	3	530	14	100	D5012
15	7.5	1325	28	100	D5013
20	5	1571	28	100	D5100
32	6	4825	67	25	D5011

Guide by actual size

4–5 mm diameter pans



6 mm diameter pans



7 mm diameter pans



8 mm diameter pans



9 mm diameter pans



10 mm diameter pans



12.5 mm diameter pans



15 mm diameter pans

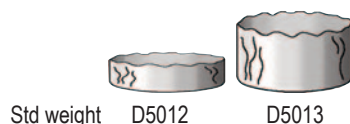

20 mm diameter pan

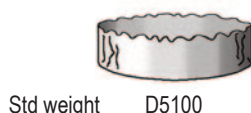

32 mm diameter pan

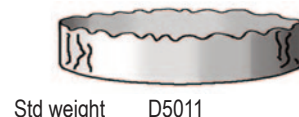

Aluminium pans for moisture determination

Diameter/mm	Height/mm	Weight/g	Pack	Part No
100	7	2.51	80	D5017
100	7	2.51	800	D5018

Sample encapsulation

Guide by actual size

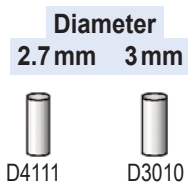

Smooth wall aluminium capsules for liquid samples

Flat base smooth wall aluminium capsules

Diameter/mm	Height/mm	Volume/ μ l <i>(calculated)</i>	Weight/mg <i>(approx average)</i>	Pack	Part No
2.7	7	40	40	250	D4111
3	7	49	32	100	D3010

Guide by actual size

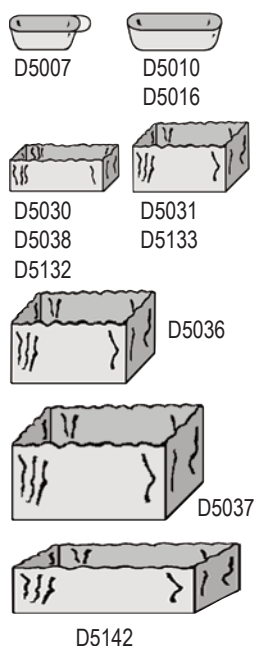

Aluminium weighing boats for solid and liquid samples

Length/mm	Width/mm	Height/mm	Thickness/mm	Volume/ μ l <i>(calculated)</i>	Weight/mg <i>(approx average)</i>	Pack	Part No
9 + tab	4	2.5	0.1	90	18	100	D5007
12	4	2.7	0.1	129	25	100	D5010
12	4	2.7	0.1	129	25	500	D5016
12	4	4	0.015	192	10	100	D5030
12	4	4	0.015	192	10	250	D5038
12	4	4	0.015	192	10	1000	D5132
12	6	6	0.015	432	16	100	D5031
12	6	6	0.015	432	16	500	D5133
15	8	8	0.015	960	30	250	D5036
20	10	9	0.015	1800	48	120	D5037
24	7	7	0.1	1176	180	100	D5142

Guide by actual size

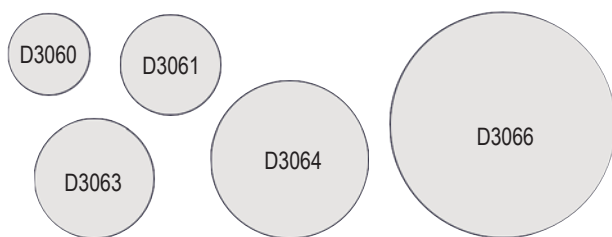

Aluminium foil discs for fibrous or sticky samples

Manufactured from high purity aluminium foil. Suitable for routine use.

Diameter/mm	Thickness/mm	Weight/mg <i>(approx average)</i>	Pack	Part No
11	0.015	4	100	D3060
13.5	0.015	6	100	D3061
16	0.015	8	100	D3063
21	0.015	14	100	D3064
30	0.015	28	100	D3066

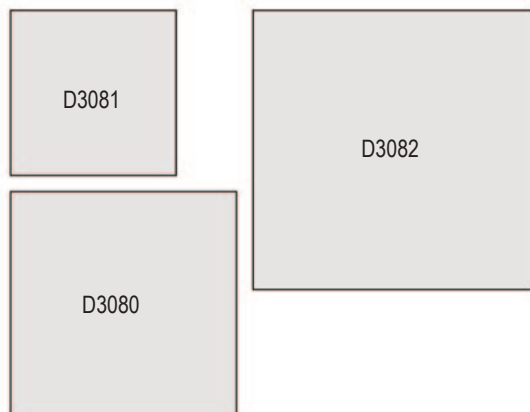

Aluminium foil squares for fibrous or sticky samples

Manufactured from high purity aluminium foil. Suitable for routine use.

Size/mm	Thickness/mm	Weight/mg <i>(approx average)</i>	Pack	Part No
22 x 22	0.015	19	100	D3080
30 x 30	0.015	36	100	D3081
37 x 37	0.015	55	100	D3082

Sample encapsulation

Nickel capsules

Pressed nickel capsules

For routine use.

Diameter/mm	Height/mm	Volume/ μ l <i>(calculated)</i>	Weight/mg <i>(approx average)</i>	Pack	Part No
4	6	75	24	250	D3507
5	8	157	40	250	D3502
5	12.5	245	85	100	D3500

Pressed nickel capsules, 1 mm hole in base

Diameter/mm	Height/mm	Volume/ μ l <i>(calculated)</i>	Weight/mg <i>(approx average)</i>	Pack	Part No
5	8	157	40	250	D3503

Ultra-clean pressed nickel capsules

Ultra-clean capsules are solvent-washed in acetone to ensure the removal of any surface contamination. *These products are sold in a multiwell plate.

Diameter/mm	Height/mm	Volume/ μ l <i>(calculated)</i>	Weight/mg <i>(approx average)</i>	Pack	Part No
5	8	157	40	96	D3504 *

Flat base smooth wall nickel capsules

Diameter/mm	Height/mm	Volume/ μ l <i>(calculated)</i>	Weight/mg <i>(approx average)</i>	Pack	Part No
3.5	10	72	130	100	D3510
7	14.5	558	523	100	D3509

Round base smooth wall nickel capsules

Diameter/mm	Height/mm	Volume/ μ l <i>(calculated)</i>	Weight/mg <i>(approx average)</i>	Pack	Part No
5	11	216	265	100	D3506
6.5	10	332	310	100	D3508



D3507



D3509



D3506

Nickel foil squares

Nickel foil squares

Suitable for routine use. Annealed.

Size/mm	Thickness/mm	Weight/mg	Pack	Part No
25 x 25	0.015	83	100	D3505

Actual size

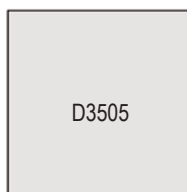

D5006

Nickel weighing boats for solid and liquid samples

Nickel weighing boats

Length/mm	Width/mm	Height/mm	Thickness/mm	Volume/ μ l <i>(calculated)</i>	Weight/mg <i>(approx average)</i>	Pack	Part No
9 + tab	4	2.5	0.15	90	81	100	D5006
12	4	2.7	0.15	129	122	100	D5111
12	4	4	0.013	192	27	100	D5122
12	6	6	0.013	432	44	100	D5123

Guide by actual size



D5006

D5111



D5122

D5123

Reagents specifically for IRMS applications are listed in the IRMS section on p 70.

Reagents

Combustion catalysts and reagents

Part No	Description	Pack
B1127	Alumina (aluminium oxide), granular 0.85 to 1.7 mm	50 g
B1126	Alumina (aluminium oxide), granular 1.7 to 3.35 mm	100 g
B1163	Aluminium oxide pellets	200 g
B1219	Cerium dioxide, granular	100 g
B1028	Cerium(IV) oxide, granular 0.85 to 1.7 mm	25 g
B1004	Chromium oxide, granular 0.85 to 1.7 mm	25 g
B1179	Chromium oxide, granular 0.85 to 1.7 mm	50 g
B1099	Chromium oxide, granular 0.85 to 1.7 mm	100 g
B1200	Chromium oxide, granular 0.85 to 1.7 mm	500 g
B1131	Chromium oxide on alumina, granular 0.85 to 1.7 mm	50 g
B1132	Chromium oxide on alumina, granular 0.85 to 1.7 mm	100 g
B1000	Cobaltous(ic) oxide, silvered, granular 0.85 to 1.7 mm	25 g
B1001	Cobaltous/ic oxide, granular 0.85 to 1.7 mm	25 g
B1121	Cobaltous/ic oxide, granular 0.85 to 1.7 mm	100 g
B1120	Cobaltous/ic oxide, silvered, granular 0.85 to 1.7 mm	100 g
B1201	Cobaltous/ic oxide, silvered, granular 0.85 to 1.7 mm	500 g
B1248	Copper oxide fine wires 4 x 0.5 mm	25 g
B1002	Copper oxide fine wires 4 x 0.5 mm	50 g
B1125	Copper oxide fine wires 4 x 0.5 mm	100 g
B1003	Copper oxide, granular 0.1 to 0.5 mm	50 g
B1160	Copper oxide, granular 0.1 to 0.5 mm	500 g
B1233	Copper oxide, granular 0.1 to 0.5 mm	1 kg
B1234	Copper oxide wire (coarse)	100 g
B1122	Copper oxide wires, fine wires 4 x 0.5 mm	250 g
B1206	Copper oxide wires, fine wires 4 x 0.5 mm	1 kg
B1209	Copper oxide wires, fine wires 4 x 0.5 mm	3kg
B1227	EA-6000 N2410692	210 g
B1054	High purity carbon, granular 0.3 to 0.85 mm	80 g
B1103	N/protein oxidation catalyst, copper oxide/platinised alumina	40 g
B1034	Nickel oxide, granular 0.85 to 1.7 mm	25 g
B1033	Nickel oxide with chromium oxide, granular 0.85 to 1.7 mm	25 g
B1260	Nickel oxide with chromium oxide, granular 0.85 to 1.7 mm	50 g
B1146	Nickel oxide with chromium oxide, granular 0.85 to 1.7 mm	100 g
B1147	Nickel oxide with chromium oxide, granular 0.85 to 1.7 mm	500 g
B1061	Nitrogen catalyst pellets	50 g
B1292	Niobium pentoxide 0.85 – 1.7 mm	25 g
B1139	Platinised alumina 1% Pt granular 0.85 to 1.2 mm	50 g
B1038	Silver tungstate on magnesium oxide, granular	25 g
B1036	Silver tungstate on magnesium oxide, granular	100 g
B1058	Silver tungstate/magnesium oxide on Chromosorb A, granular 20–30 mesh	25 g
B1402	Silver tungstate/magnesium oxide on Chromosorb A, granular 20–30 mesh	100 g
B1403	Silver tungstate/magnesium oxide on Chromosorb A, granular 20–30 mesh	500 g
B1217	Tungsten (VI) oxide, granular	60 g
B1299	Tungsten (VI) oxide, granular	300 g
B1025	Tungstic oxide, granular 0.85 to 1.7 mm	25 g
B1152	Tungstic oxide, granular 0.85 to 1.7 mm	100 g
B1031	Tungstic oxide on alumina, granular 0.85 to 1.7 mm	25 g
B1133	Tungstic oxide on alumina, granular 0.85 to 1.7 mm	100 g
B1082	Tungstic oxide/zirconium oxide, granular 0.85 to 1.7 mm	50 g
B1230	Tungstic oxide/zirconium oxide, granular 0.85 to 1.7 mm	500 g



Alumina (aluminium oxide)
granular, 1.7 to 3.35 mm
B1126



Chromium oxide granular,
0.85 to 1.7 mm
B1200



Copper oxide wires,
fine wires 4 x 0.5 mm
B1209



Niobium pentoxide 0.85–1.7 mm
B1292



Chromium oxide on alumina,
granular, 0.85 to 1.7 mm
B1131







Tungstic oxide,
granular 0.85 to 1.7 mm
B1025

Reagents





Combustion aids

Reagents

Part No	Description	Pack
B4005	Cobaltous oxide fine powder sample additive	10 g
B4003	Copper oxide fine powder sample additive	10 g
B4009	High purity carbon fine powder additive	5 g
B4012	Magnesium oxide fine powder sample additive	10 g
B1290	Niobium pentoxide sample additive 0.2–0.5 mm	25 g
B1291	Niobium pentoxide sample additive 0.2–0.5 mm	100 g
B4006	Silver oxide fine powder sample additive	1 g
B1055	Silver oxide/silver tungstate on Chromosorb P granular	25 g
B4011	Sucrose sample additive ground	50 g
B4015	Thermolite	100 g
B4002	Tin powder fine powder sample additive	10 g
B4014	Tungsten (VI) oxide powder	90 g
B4013	Tungsten (VI) oxide powder fine powder	25 g
B1188	Tungsten trioxide powder	125 g
B4000	Tungstic (VI) oxide fine powder sample additive	10 g
 B4007	'Universal' combustion additive fine powder sample additive	1 g
 B4010	Vanadium pentoxide fine powder sample additive	1 g
 B4001	Vanadium pentoxide fine powder sample additive	10 g
 B4008	Vanadium pentoxide fine powder sample additive	15 g

 These products are classified as hazardous for shipping

Interference removal reagents

Part No	Description	Pack
B1304	Brass wool	50 g
B1000	Cobaltous(ic) oxide silvered granular 0.85 to 1.7 mm	25 g
B1011	Copper granules silvered reduced 0.1 to 0.5 mm	100 g
B1012	Copper granules silvered reduced 0.1 to 0.5 mm	5 x 10 g
B1240	Fluorine absorber mix	15 g
B1063	Iron chips electrolytic chips	100 g
B1157	Iron wool very fine	25 g
B1204	Manganese dioxide sulfur reduction in U-tube	10 g
B1123	Rare earth copper oxide granular 0.85 to 1.7 mm	50 g
B1037	Silver gauze 60 mesh 12.5 x 150 mm	1
B1023	Silver gauze 60 mesh 150 x 150 mm	1
B1026	Silver gauze 610 mm x 76 mm welded in 4 places	1
B1055	Silver oxide/silver tungstate on Chromosorb P granular	25 g
B1036	Silver tungstate on magnesium oxide granular	100 g
B1145	Silver tungstate on magnesium oxide granular	500 g
 B1059	Silver vanadate on Chromosorb A granular 20–30 mesh	10 g
 B1009	Silver vanadate reagent granular 0.85 to 1.7 mm	10 g
 B1142	Silver vanadate reagent granular 0.85 to 1.7 mm	100 g
 B1144	Silver vanadate reagent granular 0.85 to 1.7 mm	500 g
B1231	Silver wool 0.05 mm fine wire	50 g
B1261	Silver wool very fine wire unreeled 89 sqcm/g	2 g
B1119	Silver wool very fine wire unreeled 89 sqcm/g	10 g
 B1113	Universal fluorine reagent	100 g
 B1112	Universal fluorine reagent	25 g

 These products are classified as hazardous for shipping

Magnesium oxide fine powder sample additive B4012



Tungsten trioxide powder B1188



Vanadium pentoxide fine powder sample additive B4001



Silver oxide/silver tungstate on Chromosorb P B1055



Universal fluorine reagent B1112



Reagents

Copper reduction reagents



Part No	Description	Pack
B1108	Copper granules, fine, reduced 0.05 to 0.2 mm	100 g
B1084	Copper granules, pound pack, reduced 0.1 to 0.5 mm	454 g
B1138	Copper granules, pound pack, reduced 0.3 to 0.85 mm	454 g
B1013	Copper granules, reduced 0.1 to 0.5 mm	100 g
B1175	Copper granules, reduced 0.1 to 0.5 mm	500 g
B1137	Copper granules, reduced 0.3 to 0.85 mm	100 g
B1011	Copper granules silvered, reduced 0.1 to 0.5 mm	100 g
B1012	Copper granules silvered, reduced 0.1 to 0.5 mm	5 x 10 g
B1249	Copper plus - wire form	567 g
B1136	Copper turnings, extra fine long strands, reduced and annealed	100 g
B1107	Copper turnings, fine long strands, reduced and annealed	200 g
B1062	Copper turnings, fine long strands, reduced and annealed	100 g
B1046	Copper wires, coarse wires, reduced 6 x 0.65 mm	50 g
B1016	Copper wires, coarse wires, reduced 6 x 0.65 mm	100 g
B1213	Copper wires, coarse wires, 3x100 g pack, reduced 6 x 0.65 mm	300 g
B1199	Copper wires, coarse wires, pound pack, reduced 6 x 0.65 mm	454 g
B1014	Copper wires, fine wires, reduced 4 x 0.5 mm	50 g
B1015	Copper wires, fine wires, reduced 4 x 0.5 mm	100 g
B1091	Copper wires, fine wires, 3x100 g pack, reduced 4 x 0.5 mm	300 g
B1083	Copper wires, fine wires, pound pack, reduced 4 x 0.5 mm	454 g
B1176	Copper wires, fine wires, reduced 4 x 0.5 mm	500 g
B1040	Copper wires for S analysis, coarse, high purity, reduced 6 x 0.65 mm	40 g
B1052	Copper wires for S analysis, coarse, high purity, reduced 6 x 0.65 mm	50 g
B1053	Copper wires for S analysis, coarse, high purity, reduced 6 x 0.65 mm	100 g
B1035	Copper wires for S analysis, high purity, reduced 4 x 0.5 mm	40 g
B1177	Copper wires for S analysis, high purity, reduced 4 x 0.5 mm	100 g
B1178	Copper wires for S analysis, high purity, reduced 4 x 0.5 mm	454 g
B1243	Electrolytic copper (110 mm length)	70 g
B1244	Electrolytic copper (110 mm length)	90 g
B1241	Electrolytic copper (130 mm length)	70 g
B1238	Electrolytic copper (140 mm length)	80 g
B1239	Electrolytic copper (140 mm length)	90 g

Adsorbent materials

Part No	Description	Pack
B3020	Chromosorb A, 20/30 non acid washed	50 g
B3010	Chromosorb P, 30–60 mesh, acid washed	10 g
B3021	Chromosorb P, 30–60 mesh, acid washed	50 g
B3013	Chromosorb P, 80–100 mesh, acid washed	10 g
B3015	Chromosorb W, 30–60 mesh, acid washed	10 g
B3017	Chromosorb W, 30–60 mesh, acid washed	25 g
B3019	Chromosorb W, 30–60 mesh, acid washed	50 g
B3018	Chromosorb W, 30–60 mesh, acid washed	100 g



Chromosorb P,
30–60 mesh, acid washed
B3010, B3021

Column packings

Part No	Description	Pack
B3022	Hayesep Q, 60–80 mesh	24 g
B3004	Molecular sieve, 5A 50–80 mesh	100 g
B3000	Molecular sieve, 5A 80–100 mesh	100 g
B3005	Molecular sieve, 5A 100–120 mesh	100 g
B3002	Porapak QS, 50–80 mesh	26 g
B3001	Porapak QS, 80–100 mesh	26 g
B3003	Porapak QS, 100–120 mesh	26 g

Reagents

Pyrolysis catalysts and reagents

Reagents

Part No	Description	Pack
C7021	Glassy carbon chips	80 g
B1065	High purity carbon granular, 0.2 to 0.5 mm	1 g
B1043	High purity carbon granular, 0.3 to 0.85 mm	5 g
B1111	High purity carbon granular, 0.85 to 1.7 mm	5 g
B1242	Nickel carbon wool	5 g
B1007	Nickel wool fine wire	2 g
B1085	Nickelised carbon, 10% Ni granular, 0.3 to 0.85 mm	5 g
B1104	Nickelised carbon, 10% Ni granular, 0.85 to 1.7 mm	5 g
B1006	Nickelised carbon, 20% Ni granular, 0.3 to 0.85 mm	5 g
B1105	Nickelised carbon, 20% Ni granular, 0.85 to 1.7 mm	5 g
B1454	Nickelised carbon, 30% Ni granular, 0.3 to 0.85 mm	2.5 g
B1086	Nickelised carbon, 30% Ni granular, 0.3 to 0.85 mm	5 g
B1088	Nickelised carbon, 30% Ni granular, 0.85 to 1.7 mm	5 g
B1087	Nickelised carbon, 40% Ni granular, 0.3 to 0.85 mm	5 g
B1106	Nickelised carbon, 40% Ni granular, 0.85 to 1.7 mm	5 g
B1181	Nickelised carbon, 50% Ni granular, 0.3 to 0.85 mm	5 g
B1182	Nickelised carbon, 50% Ni granular, 0.85 to 1.7 mm	5 g
B1005	Platinised carbon, 10% Pt granular, 0.2 to 0.85 mm	5 g
B1095	Platinised carbon, 20% Pt granular, 0.2 to 0.85 mm	5 g
D7006	Platinum gauze 225 mesh, 12 x 150 mm	approx 4.5 g



Nickel carbon wool
B1242



High purity carbon granular
0.2 to 0.5 mm
B1065

Nickelised carbon 50% Ni,
granular 0.3 to 0.85 mm
B1181

Scrubbing and purification reagents

Part No	Description	Pack
B1161	EMADrone, magnesium perchlorate	454 g
B1320	EMASorb II A, granular 20–30 mesh, CO ₂ absorbant	25 g
B1321	EMASorb II A, granular 20–30 mesh, CO ₂ absorbant	100 g
B1322	EMASorb II A, granular 20–30 mesh, CO ₂ absorbant	200 g
B1316	EMASorb II A, granular 20–30 mesh, CO ₂ absorbant	500 g
B1323	EMASorb II B, granular 8–20 mesh, CO ₂ absorbant	25 g
B1324	EMASorb II B, granular 8–20 mesh, CO ₂ absorbant	100 g
B1325	EMASorb II B, granular 8–20 mesh, CO ₂ absorbant	200 g
B1317	EMASorb II B, granular 8–20 mesh, CO ₂ absorbant	500 g
◆ B1274	Magnesium perchlorate (flakes)	25 g
◆ B1275	Magnesium perchlorate (flakes)	100 g
◆ B1285	Magnesium perchlorate (flakes), self indicating	25 g
◆ B1286	Magnesium perchlorate (flakes), self indicating	100 g
◆ B1019	Magnesium perchlorate granular, 0.7–1.2 mm, H ₂ O absorbant	25 g
◆ B1101	Magnesium perchlorate granular, 0.7–1.2 mm, H ₂ O absorbant	100 g
◆ B1081	Magnesium perchlorate granular, 0.7–1.2 mm, H ₂ O absorbant	500 g
◆ B1140	Magnesium perchlorate self indicating, granular 0.7–1.2 mm	25 g
◆ B1141	Magnesium perchlorate self indicating, granular 0.7–1.2 mm	100 g
B1021	Molecular sieve 3A 1/16 pellets	25 g
B1047	Molecular sieve 3A 1/16 pellets	100 g
B1143	Molecular sieve 3A 1/16 pellets	250 g
B1020	Molecular sieve 4A 1/16 pellets	25 g
B1044	Silica gel self-indicating, granular drying agent 2 to 6 mm	100 g
B1066	Silica gel	1 kg
B1211	Soda lime, granular 1–2.5 mm, self-indicating CO ₂ absorbant	100 g
B1189	Soda lime, granular 1–2.5 mm, self-indicating CO ₂ absorbant	200 g
B1092	Soda lime, granular 1–2.5 mm, self-indicating CO ₂ absorbant	800 g



EMASorb II A granular 20–30 mesh
B1316, B1320, B1321, B1322



Molecular sieve 3A 1/16 pellets
B1021, B1047, B1143

◆ These products are classified as hazardous for shipping

Reagents

Miscellaneous materials

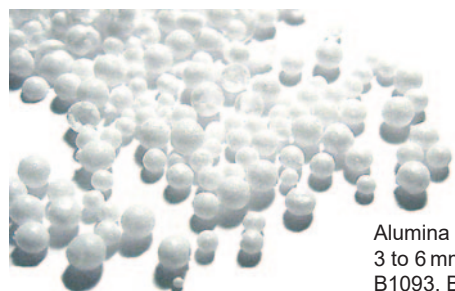

Alumina spheres
3 to 6 mm
B1093, B1090

Nickel wool
fine wire
B1007



Silica (quartz) wool
very fine
B1208, B1017,
B1276, B1102

Silica (quartz) chips
granular 2 to 4 mm
B1110, B1215, B1216



Part No	Description	Pack
B1093	Alumina (aluminium oxide) spheres 3 to 6 mm	250 g
B1090	Alumina (aluminium oxide) spheres 3 to 6 mm	50 g
B1089	Alumina (aluminium oxide) wool, fine	20 g
E2516	Cotton wool	50 g
B1045	Cotton wool, non absorbent pure	100 g
B1166	Glass wool, borosilicate fibres	454 g
B1167	Glass wool, borosilicate fibres	227 g
B1266	Glass wool rope, borosilicate fibres	454 g
B1267	Glass wool rope, borosilicate fibres	227 g
B1124	Glass wool, very fine	500 g
B1056	Glass wool, very fine	50 g
B1024	Nickel sheet, 130 x 130 mm x 0.13 mm for tube lining	1
B1048	Nickel sheet, 260 x 130 mm x 0.13 mm for tube lining	1
B1007	Nickel wool, fine wire	2 g
B1250	Quartz wool discs, 15 mm diameter	25
B1251	Quartz wool discs, 16 mm diameter	25
B1254	Quartz wool discs, 19 mm diameter	25
B1252	Quartz wool discs, 22 mm diameter	25
B1255	Quartz wool discs, 24 mm diameter	25
B1271	Silica (quartz) chips, granular 0.85 to 1.7 mm	100 g
B1272	Silica (quartz) chips, granular 0.85 to 1.7 mm	250 g
B1008	Silica (quartz) chips, granular 0.85 to 1.7 mm	50 g
B1214	Silica (quartz) chips, granular 1 to 2 mm	100 g
B1109	Silica (quartz) chips, granular 2 to 3 mm	250 g
B1215	Silica (quartz) chips, granular 2 to 4 mm	50 g
B1216	Silica (quartz) chips, granular 2 to 4 mm	100 g
B1110	Silica (quartz) chips, granular 2 to 4 mm	250 g
B1027	Silica (quartz) chips, granular isotope grade 0.2 to 0.5 mm	50 g
B1192	Silica (quartz) wool strips	10
B1208	Silica (quartz) wool, very fine	10 g
B1017	Silica (quartz) wool, very fine	5 g
B1276	Silica (quartz) wool, very fine	15 g
B1102	Silica (quartz) wool, very fine	50 g
B1404	THAM tris (hydroxymethyl) aminomethane	80 g

Gas doping reagents

Part No	Description	Pack
B1114	Copper sulfate, hydrated, granular, for gas doping	250 g
B1022	Copper sulfate, hydrated, granular, for water doping	50 g

Copper sulfate, hydrated
granular, for gas doping
B1114, B1022

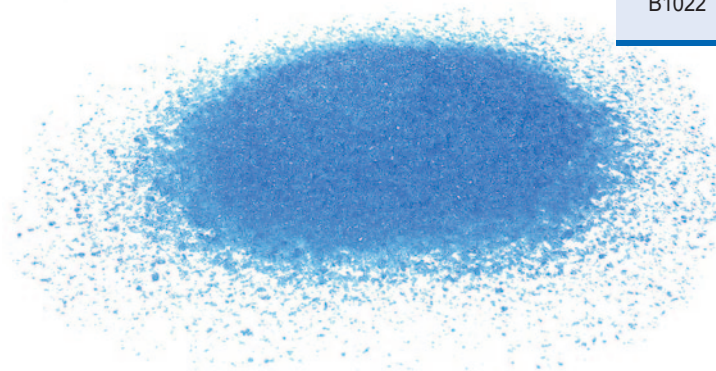

Reference materials

Pure chemical reference materials

Organic analytical standards from Elemental Microanalysis are traceable to the National Institute of Standards and Technology (N.I.S.T.), Maryland, USA and/or (where appropriate) other accredited certification organisations. These materials are suitable for use as working standards for elemental analysis and are supplied with batch certificates of analysis.

Analysis values may change depending on the batch available; please see the website for current certificate of analysis, or contact us for more information.



(Bracketed values are not certified and are for reference only)

Part No	Description	Pack	%C	%H	%N	%O	%S
B2044	2,5-(bis(5-tert-butyl-2-benzo-oxazol-2-yl) thiophene (BBOT) OAS	1 g	72.51	6.08	6.48	7.40	7.42
B2046	2,5-(bis(5-tert-butyl-2-benzo-oxazol-2-yl) thiophene (BBOT) OAS	5 g	72.51	6.08	6.48	7.40	7.42
B2049	2,5-(bis(5-tert-butyl-2-benzo-oxazol-2-yl) thiophene (BBOT) OAS	25g	72.51	6.08	6.48	7.40	7.42
B2021	2-iodobenzoic acid OAS	1 g	33.88	2.03		(12.90)	
B2034	3,5-dinitrobenzoic acid OAS	1 g	39.67	1.87	13.18	45.22	
B2118	3,5-dinitrobenzoic acid OAS	5 g	39.67	1.87	13.18	45.22	
B2008	4-bromobenzoic acid OAS	1 g	41.91	2.55		15.88	
B2143	4-bromobenzoic acid OAS	5 g	41.91	2.55		15.88	
B2009	4-chlorobenzoic acid OAS	1 g	53.60	3.15		20.52	
B2117	4-chlorobenzoic acid OAS	5 g	53.60	3.15		20.52	
B2013	4-fluorobenzoic acid OAS	1 g	59.97	3.60		(22.84)	
B2015	4-nitroaniline OAS	1 g	52.17	4.29	20.17	23.56	
B2020	8-hydroxyquinoline OAS	1 g	74.42	4.82	9.62	10.87	
B2000	Acetanilide OAS	1 g	71.10	6.71	10.34	11.81	
B2114	Acetanilide OAS	5 g	71.10	6.71	10.34	11.81	
B2122	Acetanilide OAS	25g	71.10	6.71	10.34	11.81	
B2212	Ammonium chloride standard	5 g			26.12		
B2211	Ammonium sulfate standard	5 g			21.14		
B2003	Anthracene OAS	1 g	91.31	5.58			
B2042	Aspartic acid OAS	1 g	36.14	5.31	10.49	48.09	
B2139	Aspartic acid OAS	10g	36.09	5.32	10.54		
B2138	Aspartic acid OAS	100g	36.09	5.32	10.54		
B2002	Atropine OAS	1 g	70.55	8.00	4.85	16.51	
B2006	Atropine OAS	10g	70.55	8.00	4.85	16.51	
B2112	Barium sulfate IAS	1 g					13.74
B2110	Barium sulfate IAS	5 g					13.74
B2004	Benzoic acid OAS	1 g	68.83	4.91		26.21	
B2047	Benzoic acid OAS	5 g	68.83	4.91		26.21	
B2007	Benzylthiuronium chloride OAS	1 g	47.44	5.49	13.84		15.81
B2108	Benzylthiuronium chloride OAS	5 g	47.44	5.49	13.84		15.81
B2030	Caffeine OAS	1 g	49.48	5.16	28.83	16.47	
B2104	Caffeine OAS	5 g	49.48	5.16	28.83	16.47	
B2250	Calcium carbonate	50g	11.99				
B2005	Cyclohexanone 2,4 dinitrophenylhydrazone OAS	1 g	51.70	5.03	20.12	22.92	
B2035	Cystine OAS	1 g	29.97	5.06	11.64	26.69	26.71
B2105	Cystine OAS	5 g	29.97	5.06	11.64	26.69	26.71
B2011	Dibenzylsulfide OAS	1 g	68.47	5.73			25.71
B2039	Diphenyl OAS	1 g	93.49	6.50			
B2001	DL-alanine OAS	1 g	40.49	7.91	15.78	35.90	
B2033	Ethylenediaminetetra-acetic acid (EDTA) OAS	1 g	41.16	5.53	9.66	43.68	
B2220	Ethylenediaminetetra-acetic Acid (EDTA) OAS	10g	41.05	5.51	9.54		
B2120	Ethylenediaminetetra-acetic acid (EDTA) OAS	25g	41.16	5.53	9.66	43.68	
B2146	Ethylenediaminetetra-acetic acid (EDTA) OAS	50g	41.16	5.53	9.66	43.68	
B2115	Ethylenediaminetetra-acetic acid (EDTA) OAS	50g	41.05	5.50	9.55		
B2137	Ethylenediaminetetra-acetic acid (EDTA) OAS	100g	41.05	5.50	9.55		

Reference materials specifically for IRMS applications can be found on p 78

Reference materials

Pure chemical reference materials (*continued*)

Part No	Description	Pack	(Bracketed values are not certified and are for reference only)				
			%C	%H	%N	%O	%S
B2116	Ethylenediaminetetra-acetic acid (EDTA) OAS	100 g			9.55		
B2144	Ethylenediaminetetra-acetic acid (EDTA) OAS	500 g	41.05	5.50	9.55		
B2208	Fluorene OAS	1 g	93.81	6.03			
B1405	Glutamic acid OAS	250 g	40.71	6.14	9.53		
B2019	Hexachlorobenzene OAS	1 g	25.42				
B2040	Imidazol OAS	1 g	52.92	5.91	41.28		
B2041	Isatin OAS	1 g	65.22	3.35	9.47	21.82	
B2045	Methionine OAS	1 g	40.26	7.48	9.42	21.41	21.50
B2100	Methionine OAS	25 g	40.26	7.48	9.42	21.41	21.50
B2101	Methionine OAS	50 g	40.26	7.48	9.42		
B2014	Naphthalene OAS	1 g	93.60	6.33			
B2132	Nicotinamide OAS	1 g	59.00	4.95	22.92	12.98	
B2099	Nicotinic acid OAS	15 g	58.63	4.08	11.37		
B2016	Phenacetin OAS	1 g	67.02	7.34	7.79	17.77	
B2113	Phenanthrene enriched OAS	1 g			0.50		0.54
B2148	Phenylalanine OAS	25 g	65.46	6.73	8.50	19.37	
B2024	Polyethylene standard	1 g	85.71	14.47			
B2023	Polystyrene standard	1 g	91.95	7.84			
B2109	Silver sulfate IAS	1 g					10.27
B2111	Silver sulfate IAS	5 g					10.27
B2210	Potassium nitrate standard	5 g			13.72		
B2031	Stearic acid OAS	1 g	75.97	12.68		11.20	
B2102	Stearic acid OAS	5 g	75.97	12.68		11.20	
B2032	Sucrose OAS	1 g	42.02	6.52		51.45	
B2121	Sucrose OAS	25 g	42.02	6.52		51.45	
B2037	Sulfamethazine OAS	1 g	51.82	5.07	20.04	11.41	11.51
B2106	Sulfamethazine OAS	5 g	51.82	5.07	20.04	11.41	11.51
B2107	Sulfamethazine OAS	25 g	51.82	5.07	20.04	11.41	11.51
B2017	Sulfamic acid OAS	1 g		3.08	14.39	49.64	33.16
B2036	Sulfanilamide OAS	1 g	41.84	4.68	16.23	18.56	18.63
B2048	Sulfanilamide OAS	10 g	41.84	4.68	16.23	18.56	18.63
B2043	Sulfanilic acid OAS	1 g	41.67	4.05	8.07	27.67	18.51
B2147	Sulfanilic acid OAS	5 g	41.67	4.05	8.07	27.67	18.51
B2018	Trifluoroacetanilide OAS	1 g	50.83	3.12	7.35	(8.46)	
B2022	Triphenylphosphine OAS	1 g	82.40	5.76			
B2142	Tryptophan OAS	100 g			13.70		
B2038	Urea OAS	1 g	20.02	6.74	46.61	26.66	
B2130	Urea OAS	10 g	20.02	6.74	46.61	26.66	
B2119	Urea OAS	25 g	20.02	6.74	46.61	26.66	
B2260	Zinc sulfide standard	50 g					32.9

Reference materials

ISO 17034 certified reference materials

Part No	Description	Pack	%C	%H	%N	%O	%S
B2900	Cystine CRM	1 g	29.97	5.03	11.68	26.64	26.68
B2901	Cystine CRM	5 g	29.97	5.03	11.68	26.64	26.68
B2902	Sulfanilamide CRM	1 g	41.81	4.66	16.30	18.61	18.64
B2903	Sulfanilamide CRM	10 g	41.81	4.66	16.30	18.61	18.64

Reference materials

Natural reference materials

Our wide range of natural reference materials allows analysts to choose a reference material that is a close match to the sample being analysed, and thus ensure a reliable and accurate result.



Reference materials

Part No	Description	Pack	(Bracketed values are not certified and are for reference only)				
			%C	%H	%N	%O	%S
B2273	Alfalfa OAS	30 g	41.82	6.02	2.98		0.25
B2164	Algae (bladderwrack)	30 g	32.83	4.96	1.26		2.289
B2162	Algae (spirulina) standard	30 g	47.02	6.94	10.93		0.77
B2277	Barley flour OAS	30 g	43.51	6.00	1.90		0.12
B2166	Birch leaf standard	30 g	48.09	6.55	2.12		0.172
B2209	Bitumen-asphalt CHNOS standard	30 g	84.00	10.03	3.10	1.26	0.27
B2221	Carbon and sulfur in soil standard	25 g	0.50				0.44
B2160	Chitin standard	30 g	42.72	6.49	6.25	37.84	
B2168	Coconut shell standard	30 g	49.04	6.01	0.09		
B2272	Corn gluten OAS	30 g	45.27	5.98	10.38		0.85
B2270	Corn meal OAS	30 g	45.52	6.30	1.15		0.10
B2145	Lubricant standard	2 g	82.32	13.82	1.12		2.54
B2276	Oatmeal OAS	30 g	47.00	6.67	2.03	42.10	0.16
B2170	Olive stone standard	30 g	46.39	6.12	0.20		
B2141	Orchard leaves standard	20 g	46.54	5.91	3.38		0.156
B2140	Pasta standard	10 g			2.121		
B2149	Pasta standard	100 g			2.12		
B2154	Protein standard OAS	30 g			13.32		
B2278	Rice flour OAS	30 g	39.83	6.88	1.35		0.10
B2275	Rye flour OAS	30 g	39.50	5.50	1.75		0.13
B2150	Sediment standard high organic content	30 g	7.45		0.52		0.62
B2196	Set of 7 soil standards - contains 1 of each of the following B2176, B2180, B2182, B2184, B2186, B2188, B2189						
B2188	Soil standard (chalky)	30 g	3.98		0.26		
B2184	Soil standard (clay)	30 g	2.31		0.23		(0.030)
B2186	Soil standard (loamy)	30 g	2.75		0.27		(0.044)
B2189	Soil standard (mineral)	30 g	0.34		0.029		
B2176	Soil standard (peaty)	30 g	15.52		1.24		0.44
B2180	Soil standard (sandy)	30 g	0.46		0.043		
B2182	Soil standard (silty)	30 g	2.16		0.182		(0.025)
B2152	Soil standard low organic content	30 g	1.44		0.09		0.012
B2178	Soil standard medium organic content	30 g	2.46		0.16		0.019
B2051	Soil standard NC	5 g	2.31		0.23		
B2050	Soil standard NCS	2 g	2.31		0.23		(0.030)
B2158	Sorghum flour standard	30 g	41.26		1.47		0.095
B2271	Soy bean meal OAS	30 g	45.24	5.73	7.89		0.42
B2127	Tocopherol nicotinate OAS	2 g	78.50	10.00	2.65	8.91	
B2274	Wheat flour OAS	30 g	38.86	5.45	1.81		0.13
B2156	Wheat flour standard	30 g	39.94		1.45		0.10

Elemental Microanalysis offers a comprehensive range of reference materials, covering all areas of analysis. Also available:

IRMS standards - see p 78

TOC/ROC/TIC standards

Coal and coke standards – green petroleum cokes, proximate coals, ultimate coals, as well as sulfur-only coals and cokes.

Oil and fuel standards – residual oils, diesel oils, crude oils, lube oils, and biomass fuels.

Inorganic standards – steel, titanium, and copper pin standards, cast iron standards, and ores.

For information on these other ranges see our website, or our specialist catalogues covering other areas of analysis.

Analysis Service



Our UKAS accredited ISO17025 Laboratory performs CHNOS and nitrogen/protein analysis, and offers specialized capability for air sensitive samples. We can also provide halogen, organic TOC, inorganic, and stable isotope analytical services.*

Our analytical services cover a diverse range of sample types and applications, performed by a laboratory with over 40 years of accumulated analytical expertise.

- Rapid turnaround of results
- Expedited service also available
- UKAS accredited Testing Laboratory No. 4260
- ISO 9001 certified management system

Whether you have a single sample, or an on-going research program, we offer you commitment to precision and accuracy at an affordable price.

visit our website for details or to submit a sample
elementallab.co.uk

* see scope for full details

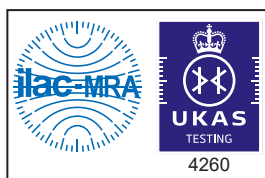

Call: +44 (0)1837 54446
Email: enquiries@microanalysis.co.uk
Technical queries: analyst@microanalysis.co.uk
Visit: elementallab.co.uk
Follow: @ElementalLab

A DIVISION OF



Elemental Microanalysis holds the following certification and accreditation:



Quartz, glassware & furnace tubes/accessories

Elementar® UNICUBE, vario MICRO cube, vario EL cube, vario ISOTOPE cube, vario ISOTOPE select

Quartz, glassware
furnace tubes

Part No	Description	Pack	Elementar® part
C3054	Ash crucible, quartz, 60 mm	1	38.00-1290
C3018	Ash finger, quartz, 60 mm	1	11.00-1170/4
C3060	Ash finger, quartz, 60 mm, pack of 10	10	11.00-1170/4
C3063	Ash finger, stainless steel, 60 mm	1	11.00-1363/4
C3068	Crucible, quartz, 30 mm	1	11.00-1319/4
C3009	Combustion/reduction tube	1	11.00-1150/4
C3022	Connecting tube silica 65 mm (inc. o-rings)	1	11.00-1331/4
C1143	Drying tube 300 mm (tube only, no caps)	1	15.00-0080
C3008	Drying tube, borosilicate, GL14	1	22 160 200/4
C3066	Drying tube with GL14 end caps	1	22 160 204/4
C3011	Oxygen lance 140 mm	1	05 000 088
C3011-10	Oxygen lance 140 mm pack of 10	10	05000088
C3012	Oxygen lance 150 mm	1	05000354
C3013	Oxygen lance 170 mm	1	05 000 658
C3021	Protection tube 105 mm	1	11.00-1317/4
C3059	Protection tube 105 mm (alt to C3021 without slits)	1	11.00-1317/4
C3017	Support tube 65 mm	1	11.00-1172/4
C3123	U-tube GL14	1	23.00-0080

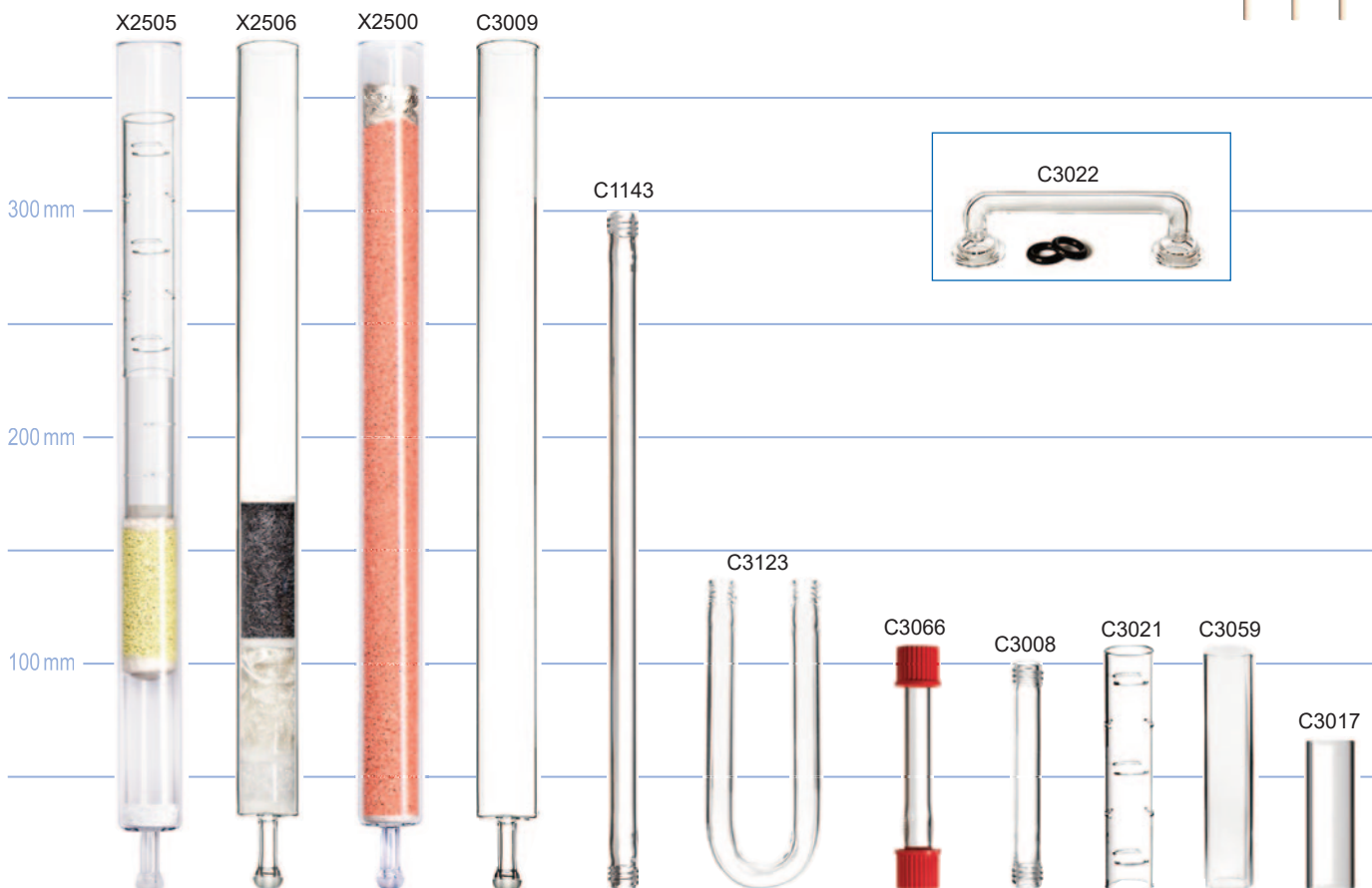
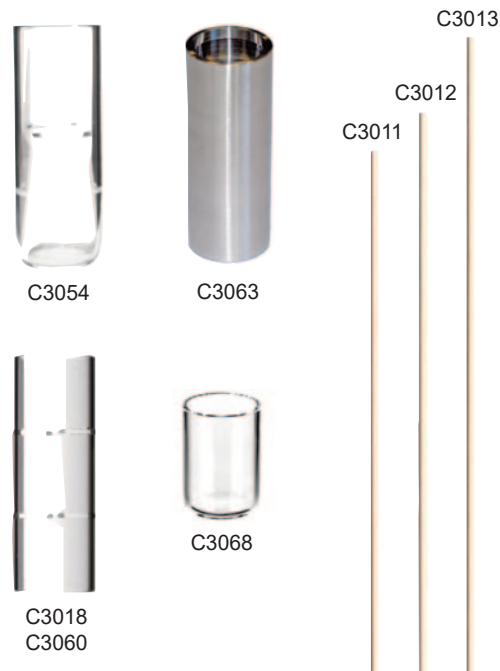

Prepacked tubes

Part No	Description	Pack
X2505	Prepacked CNS/CHNS reaction tube (with ash finger & sheath tube)	1
X2506	Prepacked N/NC/CHN reaction tube	1
X2500	Prepacked N/NC/CHN reduction tube	1

The use of Elementar® part numbers is intended for convenience only, and does not imply that the products are of OEM origin. All Elemental Microanalysis products are guaranteed to be of high quality and are deemed to be suitable alternatives in the stated instruments. All Elementar® trademarks acknowledged.

Quartz, glassware & furnace tubes/accessories

Elementar® vario PYRO cube (CNS/CN/N; for pyrolysis modes H/H-O/O see p 32 & p 79)

Part No	Description	Pack	Elementar® part
C3018	Ash finger, quartz, 60 mm	1	11.00-1170/4
C3060	Ash finger, quartz, 60 mm, pack of 10	10	11.00-1170/4
C3063	Ash finger, stainless steel, 60 mm	1	11.00-1363/41
C3051	Combustion tube	1	23.00-1150
C3125	Drying tube, 370 mm	1	23.00-1230
C1143	Drying tube, 300 mm (tube only, no caps)	1	23.00-0081
C3008	Drying tube, borosilicate, GL14	1	22 160 200/4
C3066	Drying tube with GL14 end caps	1	22 160 204/4
C3028	Oxygen lance 90 mm	1	05 002 321
C3050	Reduction tube	1	23.00-1149
C3052	Support rod, 175 mm, vario PYRO cube	1	23.00-1148
C3053	Support rod, reduction tube, 65 mm	1	11.00-1364/4
C3072	Support tube, 12 mm OD x 60 mm	1	15.00-1119
C3029	Support tube 175 mm	1	-
C3123	U-tube GL14	1	23.00-0080



C3018,
C3060



C3063



C3028

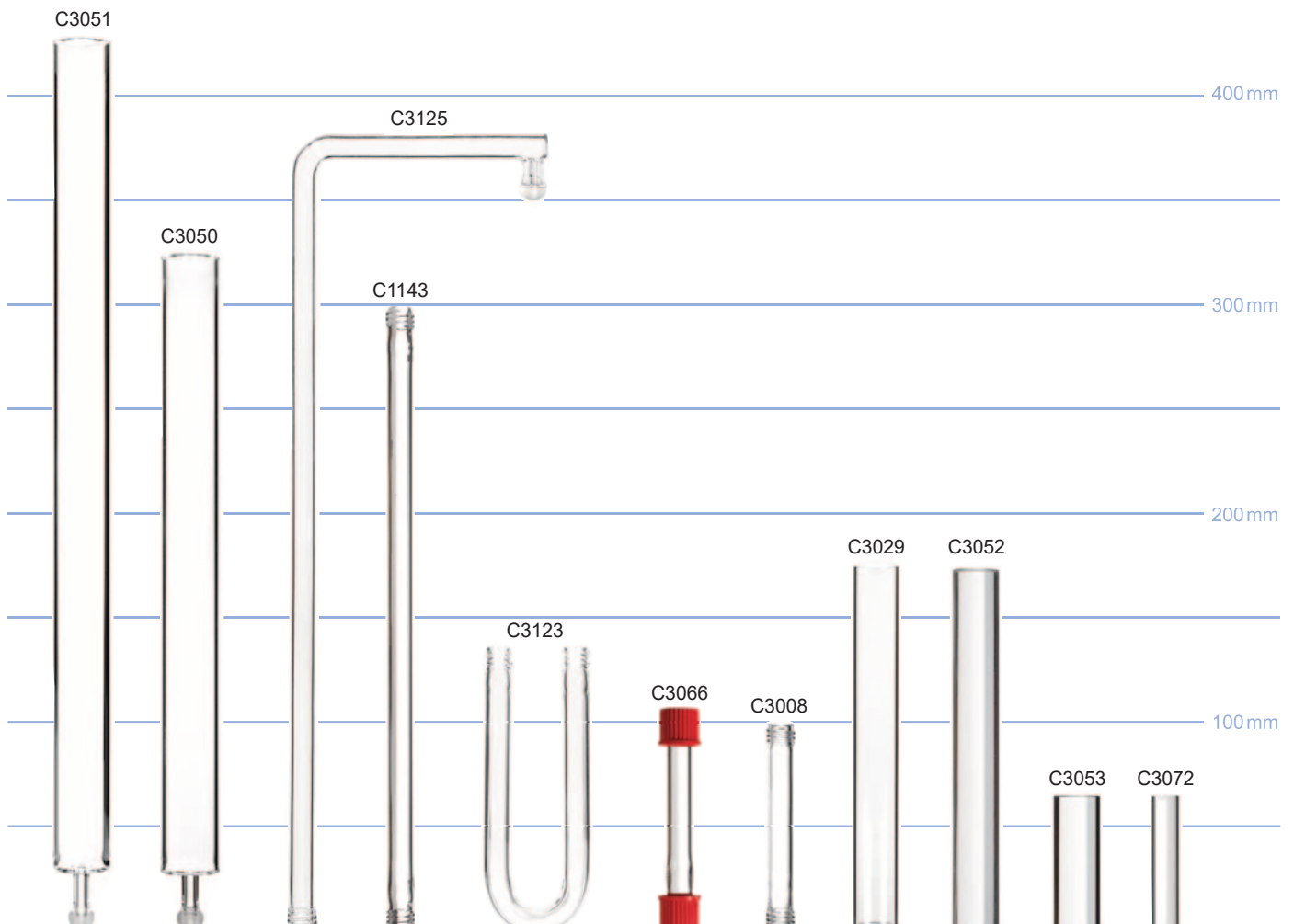

Quartz, glassware
furnace tubes

Quartz, glassware & furnace tubes/accessories

Elementar® rapid OXY cube, vario PYRO cube (pyrolysis mode)

Part No	Description	Pack	Elementar® part
C3061	Ash crucible graphite	1	23.00-1189
C7018	Ash finger - high temperature	1	15.00-1189
C1106	Ceramic tube	1	23.00-1021
C1143	Drying tube, 300 mm (tube only, no caps)	1	23.00-0081
C3066	Drying tube with GL14 end caps	1	22 160 204/4
C7017	Glassy carbon tube	1	23.00-1020
C3072	Support tube, 12 mm OD x 60 mm	1	15.00-1119

When replacing the glassy carbon tube, C7017, users are recommended to always replace the ceramic protection tube, C1106, as well.

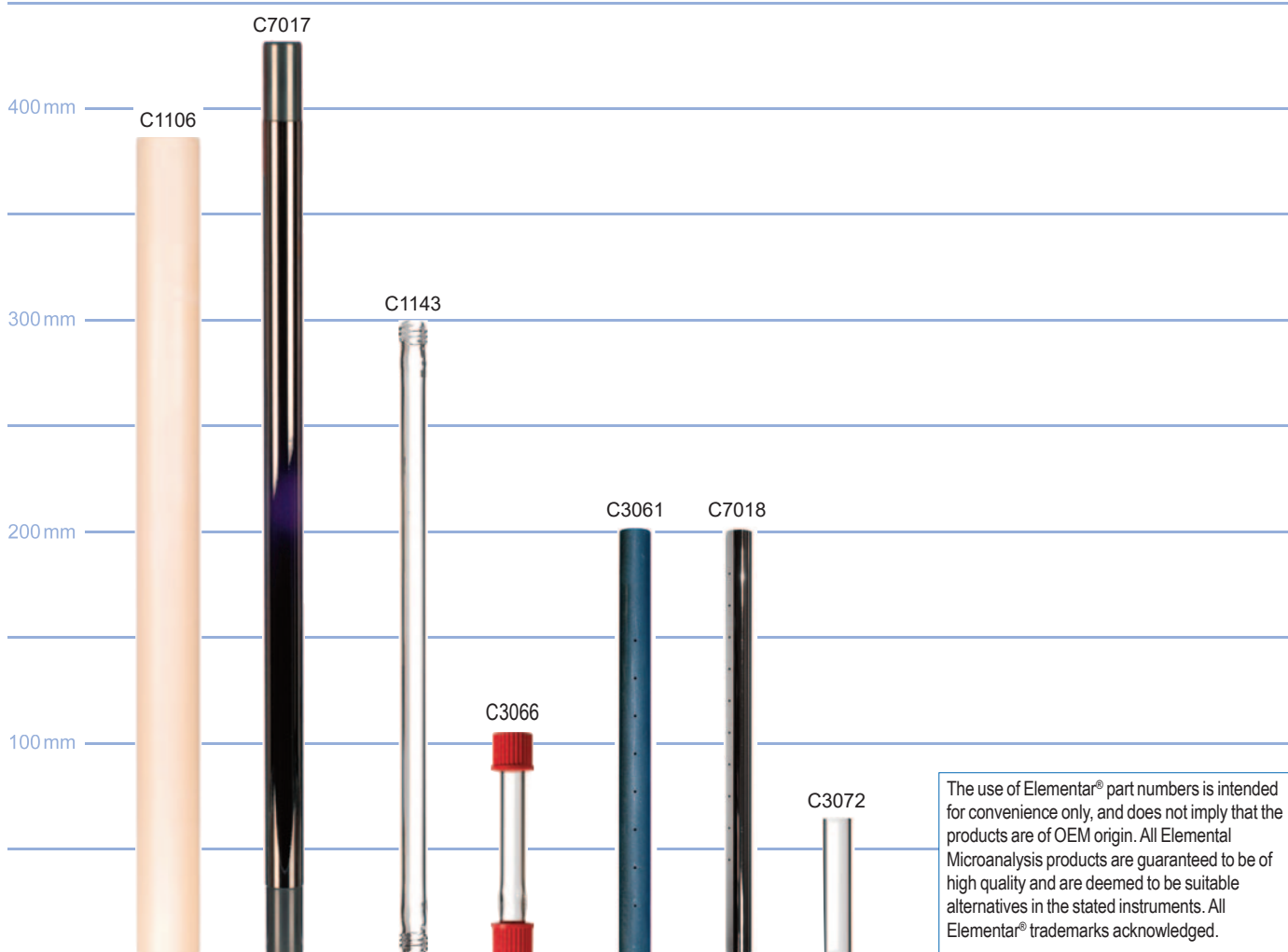

The use of Elementar® part numbers is intended for convenience only, and does not imply that the products are of OEM origin. All Elemental Microanalysis products are guaranteed to be of high quality and are deemed to be suitable alternatives in the stated instruments. All Elementar® trademarks acknowledged.

Quartz, glassware & furnace tubes/accessories

Elemental Microanalysis is the approved manufacturer and supplier of EuroVector consumables.



C1156

EuroVector EA3100

Part No	Description	Pack	EuroVector part
E1580	EA3100 12 mm empty trap assembly	1	P01-108
C1154	EA3100 12 mm tube for trap	1	C09-015
C1155	Modified quartz reactor 18/6	1	C10-071
C1156	Quartz crucible 13 x 70 mm	1	C10-186
C1129	Quartz liner for 18 mm reactor (200 mm) (use with C10-161/C10-169)	2	C10-180
C1074	Reaction tube	2	C10-059
C1099	Reaction tube heavy wall	1	C09-012

EA3100 12 mm empty trap assembly
E1580

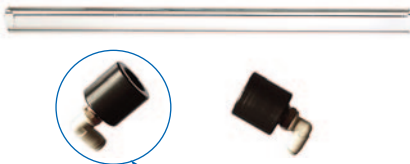

Fitting also sold separately as E1581

Prepacked tubes

Part No	Description	Pack	EuroVector part
X1077V	Prepacked tube for CHNS	1	C10-161
X1078	Prepacked oxygen pyrolysis tube	1	C10-185
X1248V	Prepacked reactor for CN, combustion	1	C10-191
X1249V	Prepacked reactor for CN, reduction	1	C10-192
X1267V	Prepacked reactor for CHN	1	C10-169
X1185	Trap for CO ₂ (10 g) EuroVector	1	C10-174
X1184	Trap for H ₂ O (10 g) EuroVector	1	C10-173

Quartz, glassware
furnace tubes

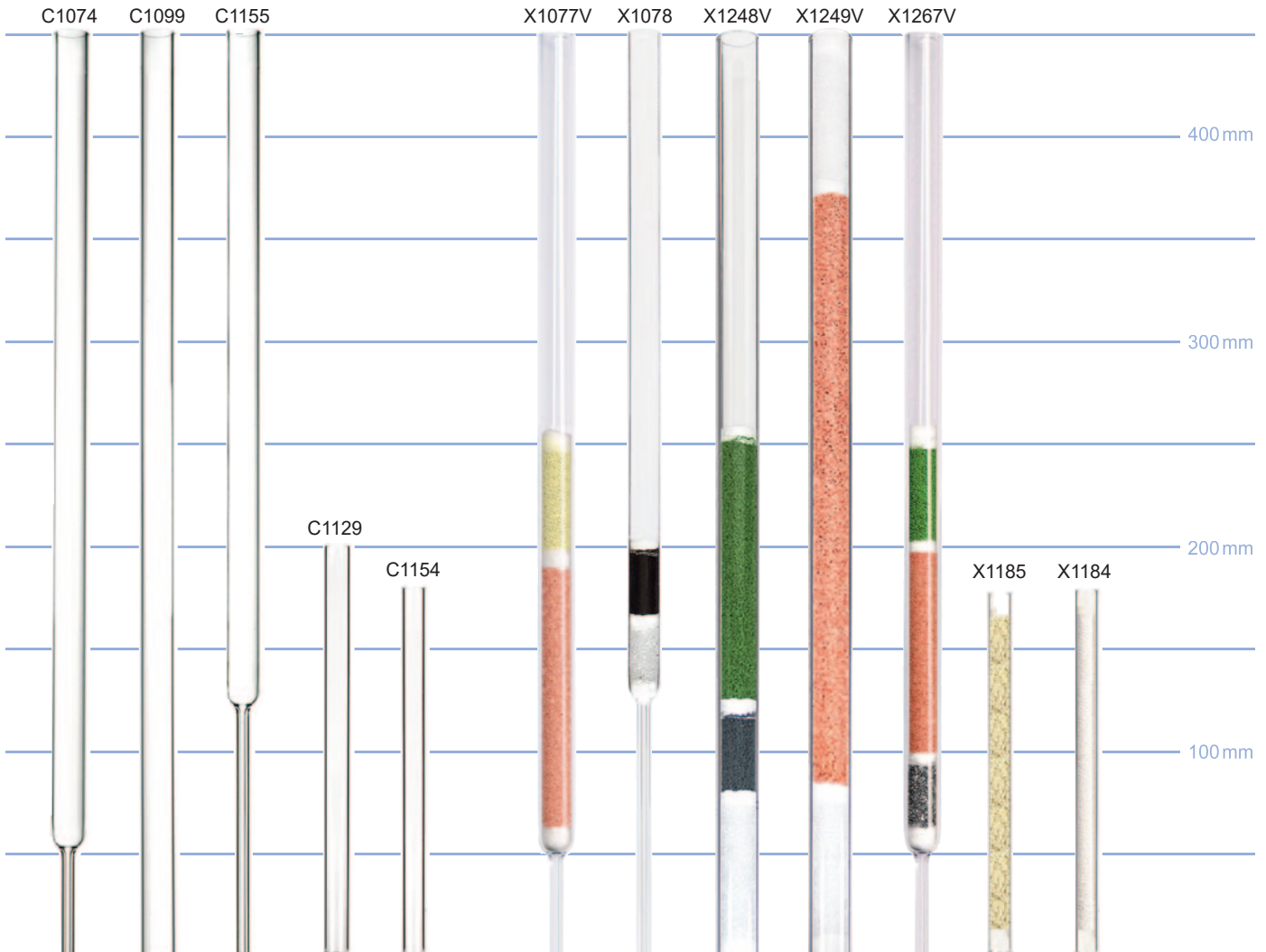

Quartz, glassware & furnace tubes/accessories

EuroVector EA3000

Part No	Description	Pack	EuroVector part
C1155	Modified quartz reactor 18/6	1	C10-071, E12512
C1126	Quartz empty reactor 20/6	1	C10-064
C1125	Quartz insert for 18 mm reactor (220 mm)	2	C10-061
C1128	Quartz liner for 18 mm reactor (235 mm) (to use with C10-161/C10-169)	2	C10-179
C1124	Quartz liner for 18 mm reactor (245 mm) (to use with C10-081/C10-084)	2	C10-062
C1074	Reaction tube	2	C10-059
C1199	Reaction tube heavy wall transparent silica	2	C10-060
C1148	Trap EuroVector 10 ml	1	C10-097

Prepacked tubes

Part No	Description	Pack	EuroVector part
X1074V	Prepacked tube CHNS/NCS/S	1	C10-084, E13040
X1077V	Prepacked tube for CHNS	1	C10-161
X1078	Prepacked oxygen pyrolysis tube	1	C10-185
X1250V	Prepacked tube CHN 18/6 single tube system	1	C10-081, E13041
X1267V	Prepacked reactor for CHN	1	C10-169

Elemental Microanalysis is the approved manufacturer and supplier of EuroVector consumables.

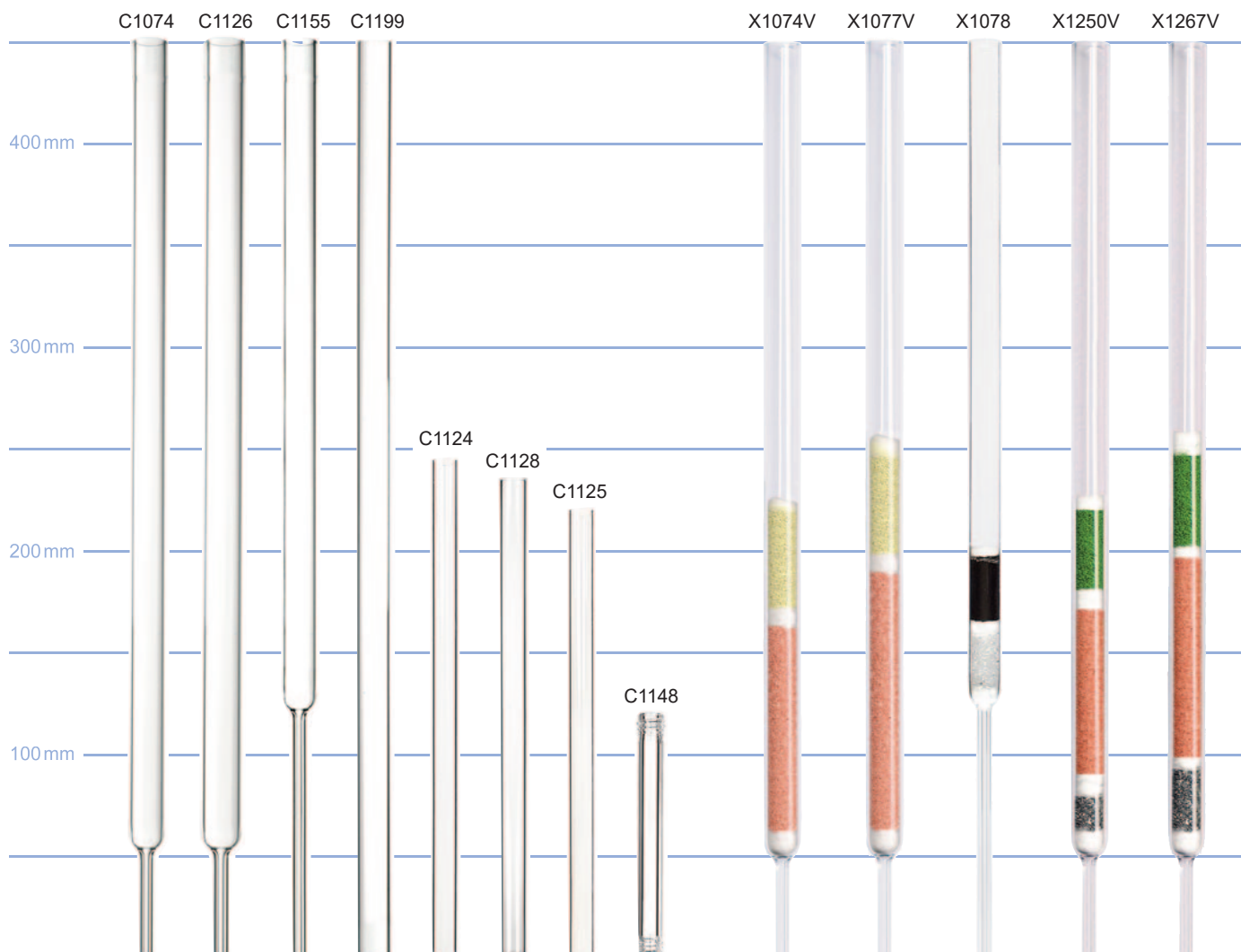

Quartz, glassware & furnace tubes/accessories

The use of LECO® part numbers is intended for convenience only, and does not imply that the products are of OEM origin. All Elemental Microanalysis products are guaranteed to be of high quality and are deemed to be suitable alternatives in the stated instruments. All LECO® trademarks acknowledged.



C4027



E2388



C4073



C4065
C4067

LECO® Truspec Micro

Part No	Description	Pack	LECO® part
C4023	Catalyst heater tube transparent silica	1	601-437
C4338	Combustion tube	1	619-065
C4358	Directing middle tube TruSpec CHNS	1	619-777
C4027	Filling funnel borosilicate glass	1	502-023
C4342	Filter tube	1	618-809
C4345	Glass tube TruSpec	1	619-425
C7000	Inner pyrolysis tube	1	608-130
C4366	Lance TruSpec CHNS Micro	1	619-774
C4051	Oxygen lance long (lance length 5.25")	1	616-146
C4332	Reagent tube	1	617-548, 633-103-225
C4337	Reagent tube 6"	1	774-638
C4341	Reagent tube	1	619-268
C4364	Reagent tube	1	619-776
C4004	Reagent tube borosilicate glass	1	775-601
C4339	Reduction tube	1	619-154

Crucibles

Part No	Description	Pack	LECO® part
E2388	Micro porous crucible	10	502-489
C4065	Porous crucible (pack of 10)	10	614-961, 614-961-110
C4067	Porous crucible (pack of 5)	5	(1/2 pack of 614-961-110)
C4073	Porous crucibles (small)	5	625-511-154

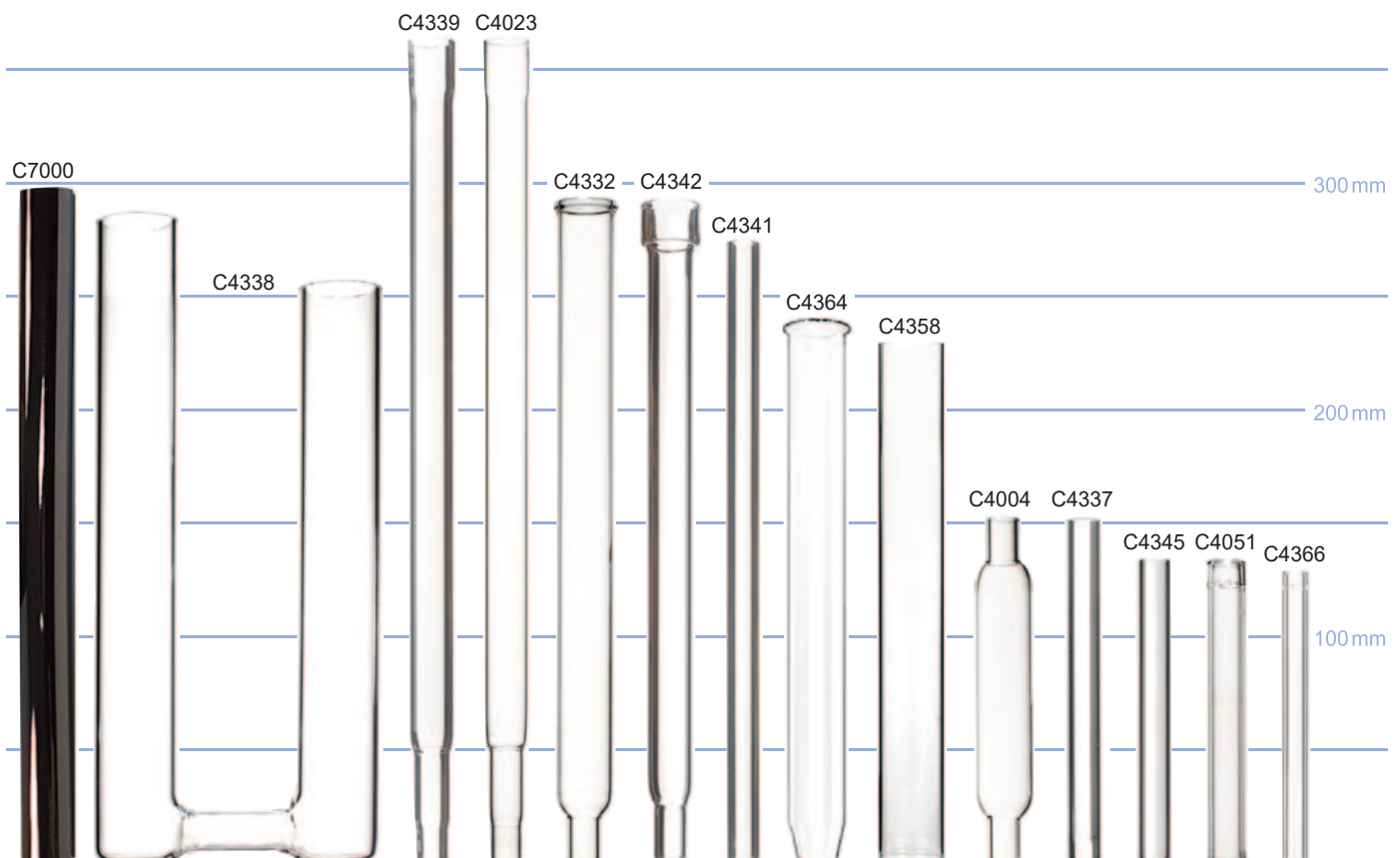

Quartz, glassware
furnace tubes

Quartz, glassware & furnace tubes/accessories

NC Technologies (Costech) ECS4010/ECS4024 & ECS8020/ECS8040

Part No	Description	Pack	NC Technologies part
C1134	Large trap for H ₂ O absorption	1	071124
C1078	Reaction tube heavy wall transparent silica	1	61121
C1022	Reaction tube transparent silica	1	061104
C1014	Scrubber tube CO ₂ threaded, borosilicate glass	1	071121, 71126
C1008	Scrubber tube H ₂ O threaded, borosilicate glass	1	71120
C1098	Sleeve insert open both ends transparent silica	5	061118

Prepacked tubes (ECS4010/ECS4024)

Part No	Description	Pack	NC Technologies part
X1220	Prepacked reaction tube CHN/CN/N transparent silica	1	061112
X1222	Prepacked reduction tube CHN/CN/N transparent silica	1	
X1224	Prepacked tube NCS/S transparent silica	1	061110
X1227	Prepacked tube oxygen pyrolysis transparent silica	1	

The use of NC Technologies/Costech part numbers is intended for convenience only, and does not imply that the products are of OEM origin. All Elemental Microanalysis products are guaranteed to be of high quality and are deemed to be suitable alternatives in the stated instruments. All NC Technologies/Costech trademarks acknowledged.

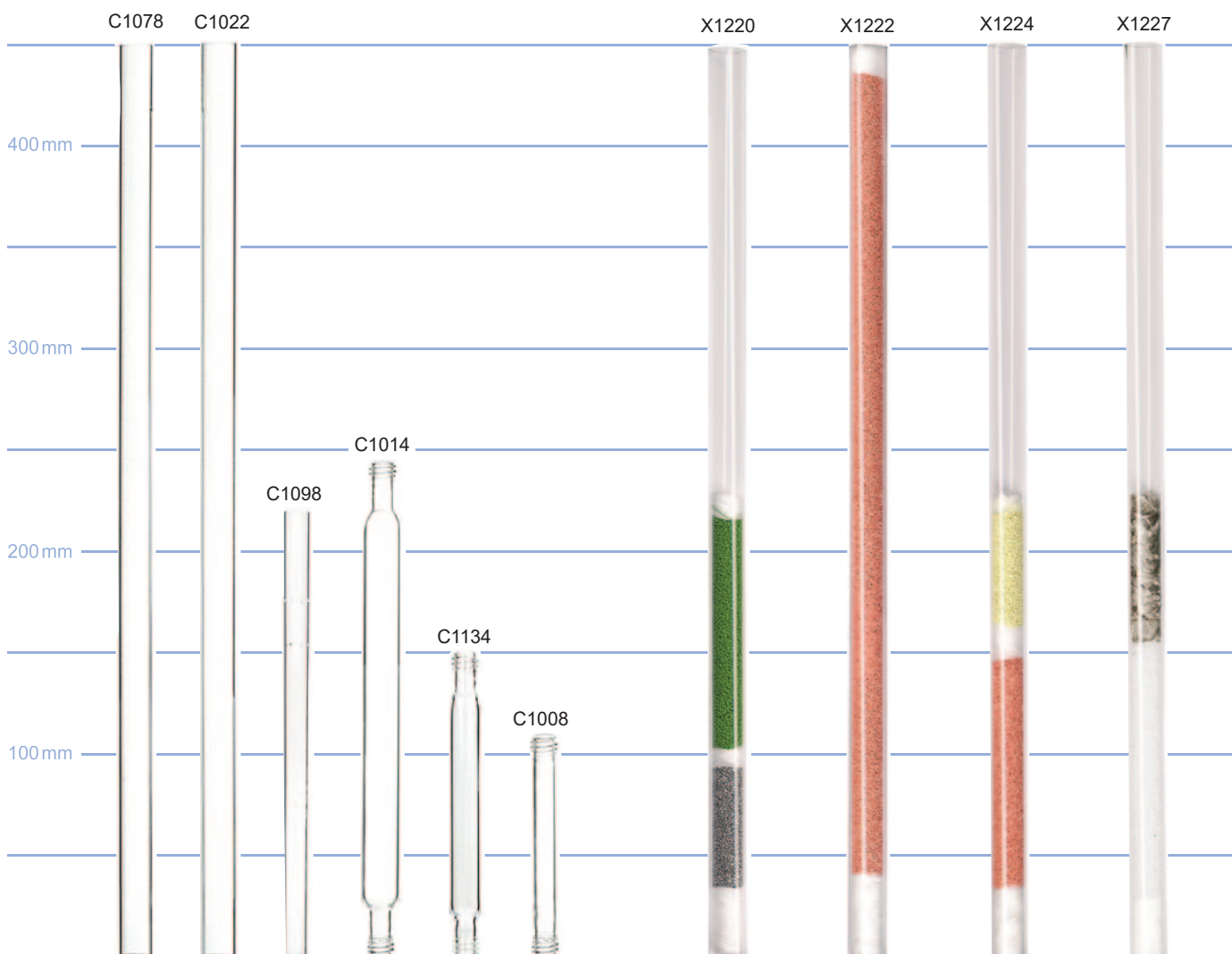

Quartz, glassware
furnace tubes

Quartz, glassware & furnace tubes/accessories

PerkinElmer® 2400 series

Part No	Description	Pack	PerkinElmer® part
C2015	Combustion tube for CHN transparent silica	1	N241-1264
C2038	Combustion tube for CHN transparent silica	5	N241-0212, N241-0153
C2024	Combustion tube for CHNS/N transparent silica	1	N241-1514
C2028	Combustion tube for CHNS/N transparent silica	5	N241-0330
C2019	Link tube transparent silica	1	N241-1300
C2018	Pyrolysis tube transparent silica	1	N241-1235
C2016	Reduction tube for CHN transparent silica	1	N241-1291
C2039	Reduction tube for CHN transparent silica	5	N241-0154
C2021	Scrubber tube transparent silica	1	N241-1359
C2025	Slitted sleeve transparent silica	1	N241-1401
C2020	Vial receptacle transparent silica	1	



C2020

Prepacked tubes

The use of PerkinElmer® part numbers is intended for convenience only, and does not imply that the products are of OEM origin. All Elemental Microanalysis products are guaranteed to be of high quality and are deemed to be suitable alternatives in the stated instruments. All PerkinElmer® trademarks acknowledged.

Part No	Description	Pack	PerkinElmer® part
X2000	Prepacked combustion tube 2400 CHN	1	N241-0695
X2001	Prepacked reduction tube 2400 CHN	1	N241-0694
X2002	Prepacked reaction tube 2400 CHNS	1	N241-0693
X2003	Prepacked oxygen pyrolysis tube 2400	1	N241-0696
X2005	PerkinElmer 2400 oxygen reduction furnace tube	1	N241-0698

Quartz, glassware
furnace tubes

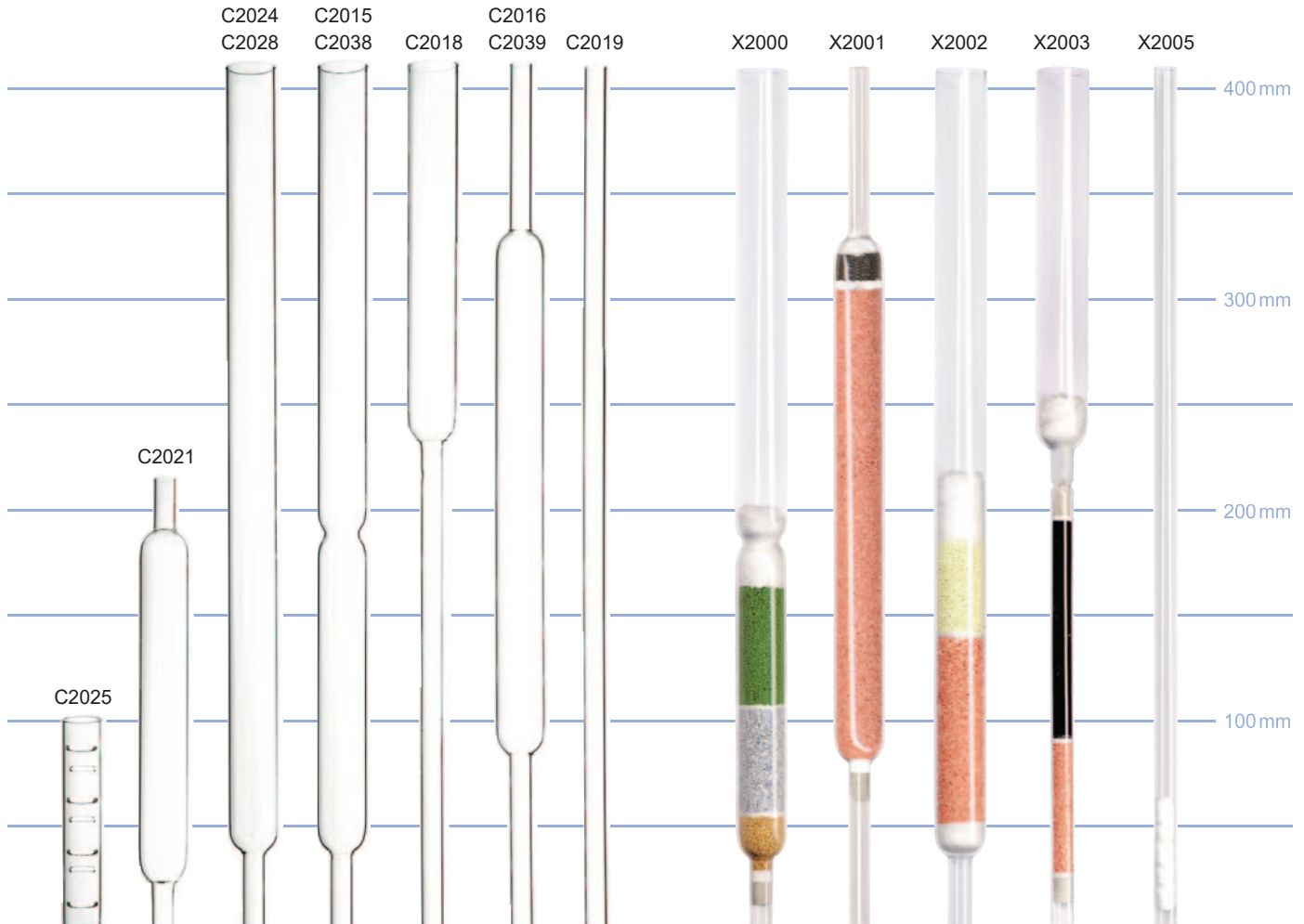

Quartz, glassware & furnace tubes/accessories

Thermo Fisher Scientific® FlashSmart, Flash IRMS, Flash HT, Flash 2000, FlashEA1112 (CHN/S/O; see pp 71 & 79 for O/H pyrolysis)

Part No	Description	Pack	Thermo Fisher Scientific® part
F5150	High performance alloy reactor	1	46820075
F5153	High performance Inconel reactor crucible 18 mm OD	1	25205011
F5162	Large adsorbent trap CO ₂ without fast connectors	1	28113064
C1120	Quartz liner	1	25204510
C1127	Quartz liner	5	25204510
C1069	Reaction tube transparent silica	1	46820065, 46820070
C1014	Scrubber tube CO ₂ threaded, borosilicate	1	28113090
C1008	Scrubber tube water threaded borosilicate glass	1	23103008
E6101	Small trap with o-rings, threaded caps and fitting	1	28113102
E2341	Small water adsorption filter assembly (with caps, o-rings and SS fitting) without fast connectors	1	28113104
C1070	Spare doping vessel for E2220	5	
C1016	Swarf crucible 30 x 13 mm for C1069/C1072/C1078	5	25204600



C1016



F5153

Quartz, glassware
furnace tubes

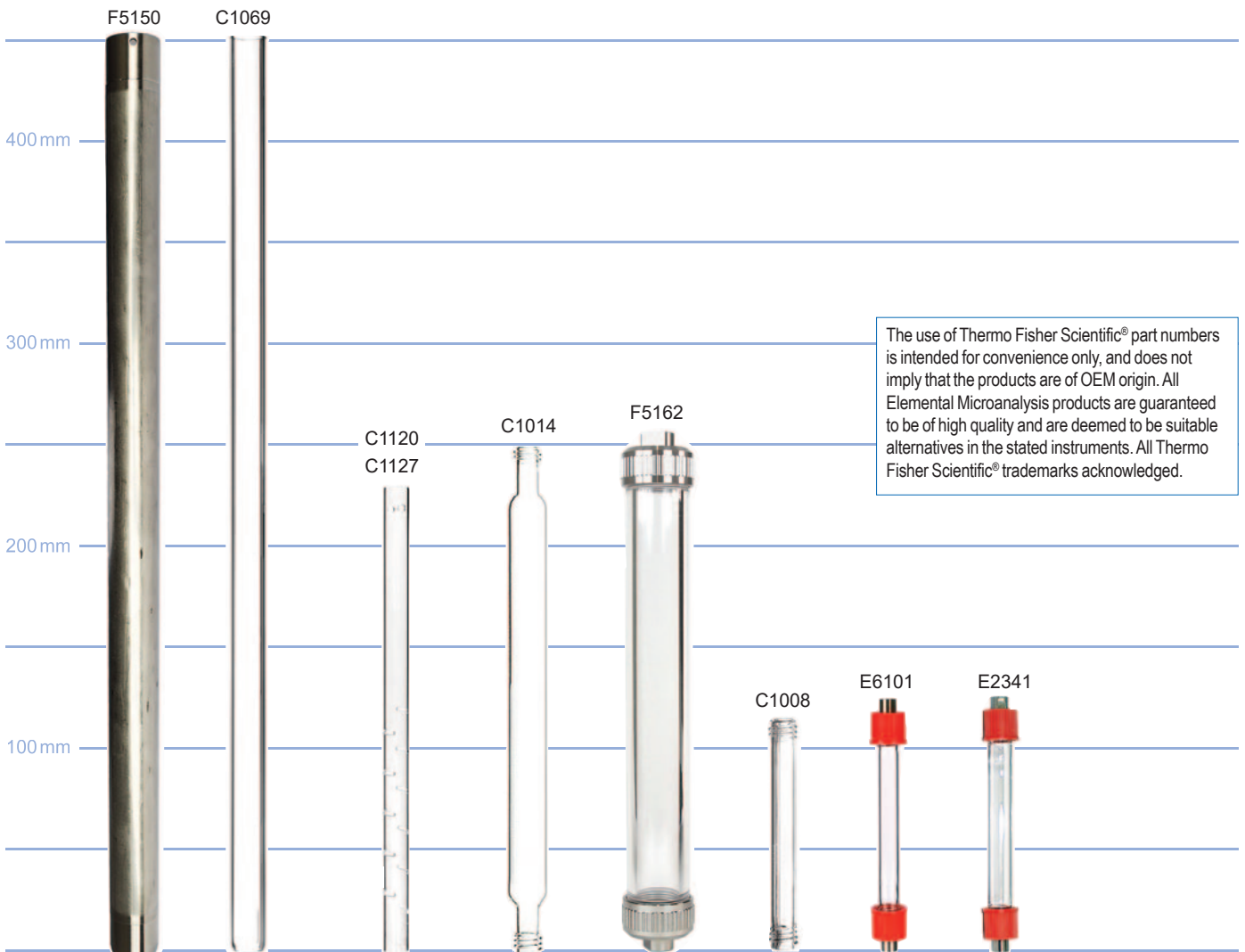

The use of Thermo Fisher Scientific® part numbers is intended for convenience only, and does not imply that the products are of OEM origin. All Elemental Microanalysis products are guaranteed to be of high quality and are deemed to be suitable alternatives in the stated instruments. All Thermo Fisher Scientific® trademarks acknowledged.

Quartz, glassware & furnace tubes/accessories

Thermo Fisher Scientific® FlashSmart, Flash IRMS, Flash HT, Flash 2000, FlashEA1112 (CHN/S/O; see pp 71 & 79 for O/H pyrolysis)

Prepacked tubes

Part No	Description	Pack	Thermo Fisher Scientific® part
X1042	Prepacked reduction tube, Flash EA1112	1	
X1150	Prepacked oxidation high performance alloy reactor	1	46802008
X1151	Prepacked combustion/reduction tube, CHN/NC/N	1	46802009
X1152	Prepacked combustion/reduction tube, CHNS/NCS/S (Cu wires replaces electrolytic copper)	1	46802007
X1153	Prepacked reactor tube, oxygen, EA1112	1	
X1154	Prepacked reactor tube, N/NC, EA1112	1	
X1155	Flash EA1112 prepacked reaction tube using electrolytic copper	1	46802007
X1157	Flash prepacked reaction tube (electrolytic wires) CHNS (for use without quartz liner)	1	
X1160	Prepacked reactor, CHNS/NCS/S, including crucible	1	46802015
X1167	Prepacked reactor tube, oxygen	1	
X1170	Prepacked oxidation reactor for Flash IRMS	1	46820076
X1171	Prepacked reduction reactor for Flash IRMS argon sealed	1	46820077
X1172	Prepacked ox/red reactor, NCS, for Flash HT plus	1	46802021

Quartz, glassware
furnace tubes

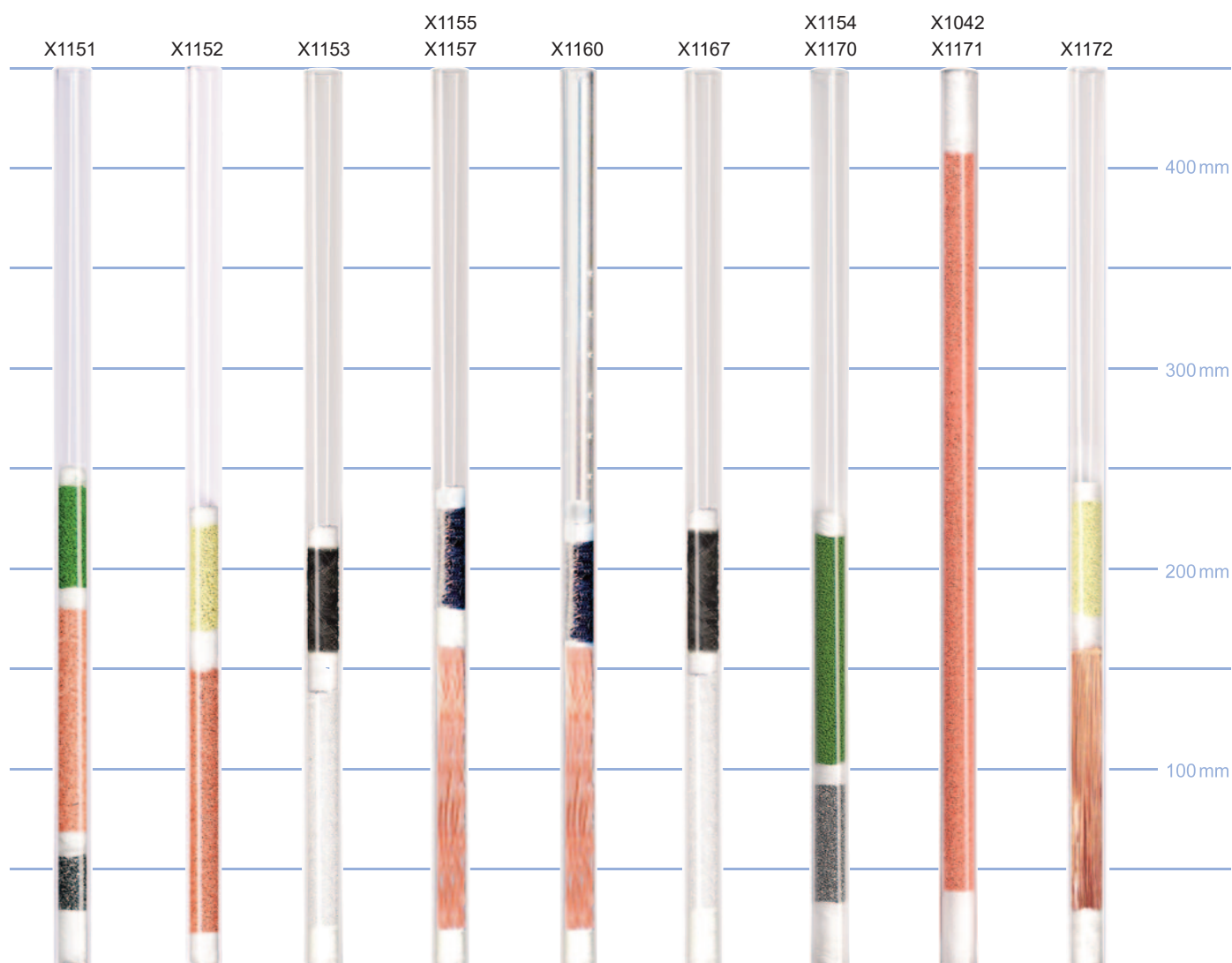

O-rings, seals & caps

Elementar® UNICUBE, vario MICRO cube, vario EL cube, vario ISOTOPE cube, vario ISOTOPE select, vario PYRO cube, rapid OXY cube

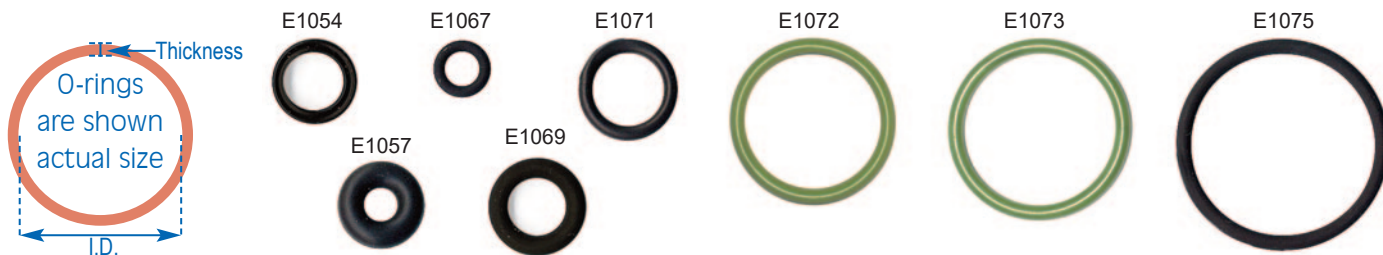

Part No	Description (I.D. & thickness)	Pack	Elementar® part
E1054	Quad-ring, 7.65 mm x 1.78 mm	1	05 000 353
E1054-10	Quad-ring, 7.65 mm x 1.78 mm	10	05 000 353
E1057	O-ring, 4 mm x 4 mm	1	05 000 369
E1067	O-ring, 4.5 mm x 1.5 mm	1	05 000 249
E1067-10	O-ring, 4.5 mm x 1.5 mm	10	05 000 249
E1069	O-ring, 7.5 mm x 2.5 mm	1	05 000 416
E1069-10	O-ring, 7.5 mm x 2.5 mm	10	05 000 416
E1071	O-ring, 9.25 mm x 1.78 mm	1	05 000 368
E1071-10	O-ring, 9.25 mm x 1.78 mm	10	05 000 368
E1072	O-ring, 18 mm x 2 mm	1	05 000 096
E1073	O-ring, 20 mm x 2 mm	1	03 654 627
E1073-10	O-ring, 20 mm x 2 mm	10	03 654 627
E1075	O-ring, 24 mm x 2 mm	1	03 002 267
E1075-10	O-ring, 24 mm x 2 mm	10	03 002 267
E1087	O-ring, black, 7.59 x 2.62 mm	1	05 001 302
E1173	O-ring, 5 mm x 1.5 mm	1	05 000 425
E1368	O-ring, 10.3 mm x 2.4 mm	1	05 002 254
E1369	O-ring, green, 29.5 x 3 mm	1	05 002 306
E1370	Quad-ring, black, 18.2 x 3.53 mm	1	05 002 303
E1371	Quad-ring, black, 29.74 x 3.53 mm	1	05 002 304

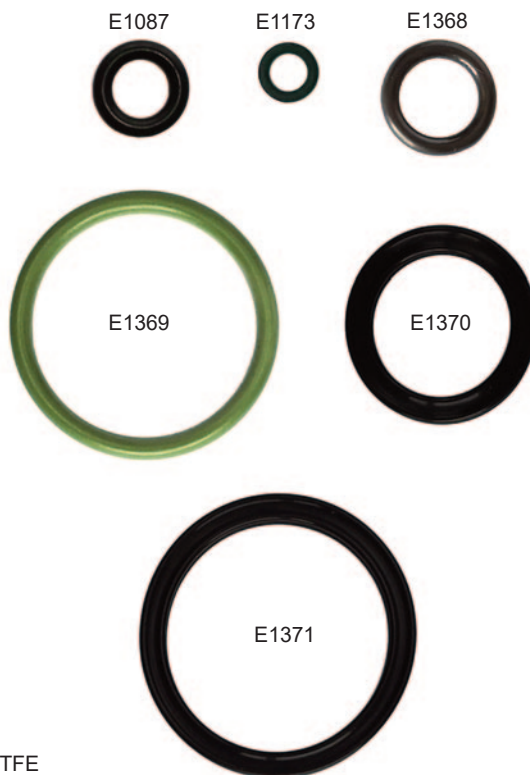

Cap kit for threaded joints
C1020

O-ring, Schott-type silicone/PTFE
E1021

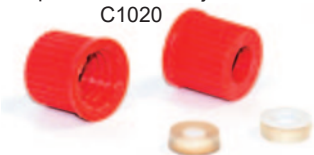

GL14 blanking cap red
E2538



Seal for oxygen lances
- 3 mm seals
E1049

Part No	Description	Pack	Elementar® part
C1020	Cap kit for threaded joints, GL14 caps & PTFE backed silicone seals	2	
E1021	O-ring, Schott-type silicone/PTFE	10	29013603
E1049	Seal for oxygen lances - 10 x 3 mm seals	10	05 000 247
E1050	Seal for oxygen lances - (10 cm piece, ~30 x 3 mm seals)	1	05 000 247
E1050-10	Seal for oxygen lances (1 m total of tubing - up to 330 seals)	10	05 000 247
E2538	GL14 blanking cap red	2	



Seal for oxygen lances
- 10 cm piece
E1050

Cut your own seals and save!

The use of Elementar® part numbers is intended for convenience only, and does not imply that the products are of OEM origin. All Elemental Microanalysis products are guaranteed to be of high quality and are deemed to be suitable alternatives in the stated instruments. All Elementar® trademarks acknowledged.

O-rings, seals & caps

Elemental Microanalysis is the approved manufacturer and supplier of EuroVector consumables.

EuroVector EA3100, EA3000

Part No	Description	Pack	EuroVector part
E1510	O-ring 12.42 x 1.78 mm OR2050 silicon	1	W08-031
E1511	O-ring 6 mm OR3021 FPM	1	W08-040
E1512	O-ring 12.5 x 2.65 ISO3601G	1	W08-041
E1513	O-ring 17.86 x 2.62 Sil	1	W08-042
E1514	O-ring 13.2 x 2.65 ISO3601G	1	W08-043
E1515	O-ring 18 x 2.65 ISO3601G FKM80	1	W08-044
E1516	O-ring 8 x 2.65 ISO3601G NBR	1	W08-045
E1517	O-ring 17.13 x 2.62 ISO3601G	1	W08-111
E1518	Parker seal 20 mm	1	A02-009
E1519	Parker seal 8 mm	1	A04-054
E1520	O-ring 8.75 x 1.78 OR108 neoprene	1	W08-029
E1521	O-ring 26.5 X 2.65 OR 3106 NBR	1	W08-035
E1522	O-ring 10.6 x 1.8 ISO3601	1	W08-036
E1523	O-ring 15.08 x 2.62 neoprene	1	W08-052
E1525	O-ring 17 x 1.8 2056 NBR	1	W08-102
E2517	GL14 screw cap	1	C10-101



GL14 screw cap
E2517

O-rings
are shown
actual size

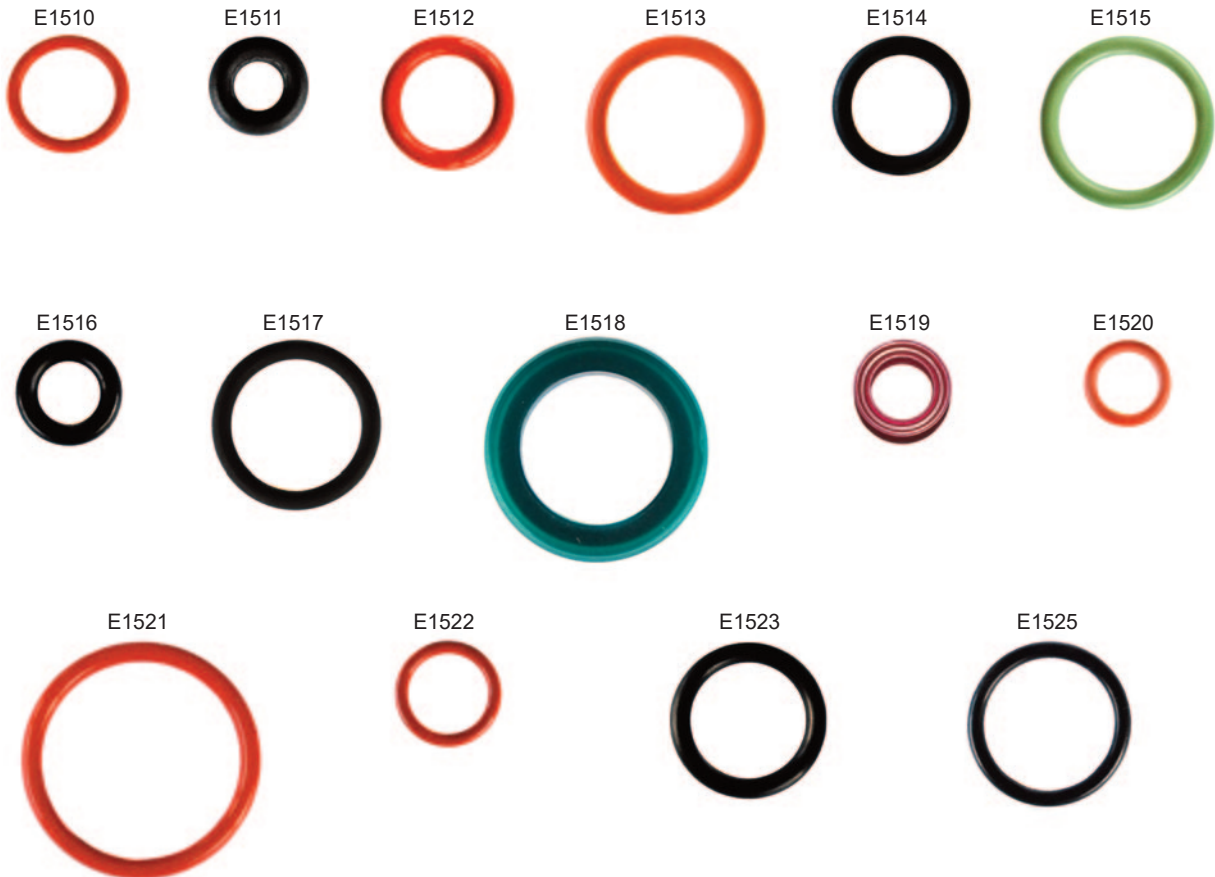

O-rings,
seals & caps

O-rings, seals & caps

LECO® Truspec Micro

O-rings
are shown
actual size

Part No	Description (I.D. & thickness)	Pack	LECO® part
E1101	O-ring catalyst heater tube 14.0 mm x 2.6 mm	1	601-442
E1109	O-ring doser valve assembly, 2.9 mm x 1.8 mm	10	772-269
E1110	O-ring, 6.0 mm x 2.6 mm	1	772-520
E1114	O-ring sample drop block, 4.5 mm x 1.8 mm	1	773-913
E1139	O-ring lance assembly, 17.2 mm x 1.8 mm	2	780-831
E1140	O-ring combustion tube, 36.1 mm x 3.5 mm	1	616-138
E1311	O-ring, 17.1 mm x 2.6 mm	1	771-407
E1342	O-ring, 41.0 mm x 2.6 mm	1	774-425
E1344	O-ring, 31.4 mm x 2.6 mm	1	601-684
E1345	O-ring, 5.2 mm x 2.6 mm	1	617-136
E1360	O-ring, 29.8 mm x 2.6 mm	1	702-557
E2387	O-ring, 14.3 mm x 2.4 mm	1	608-089
E2389	O-ring, 7.9 mm x 1.6 mm	1	769-310
E2390	O-ring, 9.5 mm x 1.6 mm	1	603-493



O-rings,
seals & caps

NC Technologies (Costech) ECS4010/ECS4024



GL14 blanking cap red
E2538

Part No	Description	Pack	NC Technologies part
E2538	GL14 blanking cap red	2	
E1023	O-ring Schott-type silicone/PTFE	2	071122
E1021	O-ring Schott-type silicone/PTFE	10	071125
E1041	Seal, chamfered square profile	5	061106
E1024	Silicone o-ring 12 x 6 mm	2	71125

O-ring, Schott-type silicone/PTFE
E1021, E1023

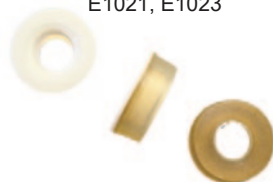

E1024



The use of OEM part numbers is intended for convenience only, and does not imply that the products are of OEM origin. All Elemental Microanalysis products are guaranteed to be of high quality and are deemed to be suitable alternatives in the stated instruments. All OEM trademarks acknowledged.

O-rings, seals & caps

O-rings
are shown
actual size

PerkinElmer® 2400 series

Part No	Description	Pack	PerkinElmer® part
E1009	O-ring silicone rubber	10	0990-2188
E1010	O-ring nitrile rubber	1	0990-2048
E1013	O-ring	10	0240-1583
E1014	O-ring nitrile rubber	2	0990-2123
E1015	O-ring nitrile rubber	2	0240-1293
E1019	O-ring	1	0240-2133



O-rings,
seals & caps

Thermo Fisher Scientific® FlashSmart, Flash HT/HTplus, Flash 2000, FlashEA1112

Part No	Description	Pack	Thermo Fisher Scientific® part
E1021	O-ring Schott-type silicone/PTFE	10	29013603
E1023	O-ring Schott-type silicone/PTFE	2	29013603
E1024	Silicone o-ring 12 mm x 6 mm	2	29003635
E1041	Seal chamfered square profile	5	29022910
E1059	O-ring, 23.4 mm x 3.5 mm	2	29010082
E1582	GL32 silicone seal for threaded scrubbers	2	29003193
E1583	Cap kit for GL32 threaded joint red cap & silicone seal	1	
E2538	GL14 blanking cap red	2	
E6050	Top o-ring for alloy reactor, Flash EA1112	5	29020682
E6051	Bottom o-ring for alloy reactor, Flash EA1112	5	29020649
E6052	Bottom o-ring for reactor, Flash series	5	29020640
E6055	MAS200R autosampler piston o-ring	1	29002195
E6059	Green o-ring for shaft of MAS plus autosampler	3	29030343

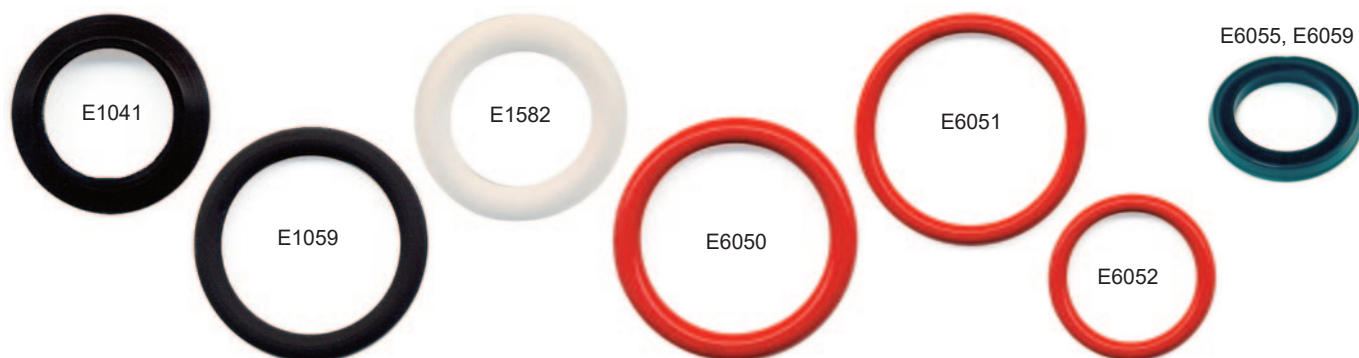

Consumables kits

Elementar® UNICUBE

Part No	Description	Elementar® part
X3051	Elementar® consumables kit for UNICUBE	unicu-4k-CHNS/CNS

Visit our website,
elementalmicroanalysis.com
 to view the contents lists of
 our consumables kits.

EuroVector EA3100

Part No	Description	EuroVector part
X3258	CHNS consumables kit for 1000 analyses	C11-062
X3262	Oxygen consumables kit for 1000 analyses	C11-065
X3265	CHN consumables kit for 1000 analyses	C11-063
X3271	(CN) Dual consumables kit for 1000 analyses	C11-073
B2131	Standards kit CHNS/CHNS-O (cystine, sulfanilamide, BBOT, sulfanilic acid, 4 x 0.5 g)	C10-166
B2134	Standards kit CHN/CHN-O (acetanilide, EDTA, urea, aspartic acid, 4 x 0.5 g)	C10-176
B2061	Standards kit CHN/CHN-O (acetanilide, EDTA, benzoic acid, aspartic acid, 4 x 0.5 g)	C10-184



X3265
 CHN consumables kit
 for 1000 analyses,
 EuroVector EA3100

EuroVector EA3000

Part No	Description	Eurovector part
X3258	CHNS consumables kit for 1000 analyses	C11-062
X3265	CHN consumables kit for 1000 analyses	C11-063
X3269	Consumables kit for 1000 (CHN) dual analyses in EA3000	C11-037
X3262	Oxygen consumables kit for 1000 analyses	C11-065

These products are classified as hazardous for shipping

Elemental Microanalysis is
 the approved manufacturer
 and supplier of EuroVector
 consumables.

NC Technologies (Costech) ECS4010/ECS4024

Part No	Description	Costech part
X3212	Kit for 1000 CHNS analyses	43.13.011
X3210	Kit for 1000 NC analyses	

PerkinElmer® 2400

Part No	Description	PerkinElmer® part
X2010	Consumable kit CHNS, PE2400	N2410512
X2011	Consumable kit CHNS, for 2000 analyses	N2410684
X2012	Consumable kit CHN, for 2000 analyses	N2410683
X2013	CHN complete kit for 2000 runs, PE 2400	N2410506
X2014	Consumable kit CHN reduction, 500 analyses	N2410681
X2015	Consumable kit CHN combustion, 2000 analyses	N2410680
X2016	Consumable kit CHNS, PE2400	N2410682

These products are classified as hazardous for shipping

The use of OEM part numbers is intended for convenience only, and does not imply that the products are of OEM origin. All Elemental Microanalysis products are guaranteed to be of high quality and are deemed to be suitable alternatives in the stated instruments. All OEM trademarks acknowledged.

Consumables kits

Typical kit contents

X7072

Consumable kit 1000 analysis kit, FlashSmart, CHN



D1019 x 1, tin containers
mega box



B1017 x 1, silica
(quartz) wool



B1004 x 2,
chromium
oxide,
granular

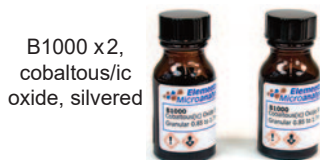

B1000 x 2,
cobaltous/iron
oxide, silvered



B1046 x 4,
copper
wires

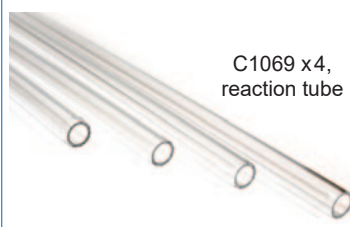

C1069 x 4,
reaction tube

The use of OEM part numbers is intended for convenience only, and does not imply that the products are of OEM origin. All Elemental Microanalysis products are guaranteed to be of high quality and are deemed to be suitable alternatives in the stated instruments. All OEM trademarks acknowledged.

Thermo Fisher Scientific® FlashSmart

Part No	Description	Thermo Fisher Scientific® part
X7070	Consumable kit 1000 analysis kit, FlashSmart N/protein	19002560
X7071	Consumable kit 1000 analysis kit, FlashSmart NC soil	19002561
X7072	Consumable kit 1000 analysis kit, FlashSmart CHN	19002562
X7073	Consumable kit 1000 analysis kit, FlashSmart CHNS/NCS/S (no prepack)	19002564
X7074	Consumable kit 1000 analysis kit, FlashSmart CHNS (with prepacked tube)	19002565
X7075	Consumable kit 1000 analysis kit, FlashSmart oxygen	19002563
X7076	Consumable kit 1000 analysis kit, FlashSmart N ORG	19002566
X7077	Consumable kit 1000 analysis kit, FlashSmart NC ORG	19002567
X7078	Consumable kit 1000 analysis kit, FlashSmart N lubricant	19002568
X7079	Consumable kit 5000 analysis, FlashSmart N/protein 1 of 2	19002575
X7080	Consumable kit N/protein and N/brew determination (for liquid samples)	19002569

Thermo Fisher Scientific® Flash HT/HT plus

Part No	Description	Thermo Fisher Scientific® part
X1081	Consumables kit 1000 analysis, FlashEA1112 CHNS/NCS/S empty tubes	19002411
X1082	Consumables kit 1000 analysis, EA1112 CHNS/NCS/S Prepacked tubes	19002412
X1084	Kit for 1000 analyses, NC/IRMS	19002418
X1114	NCS 1000 analysis kit, Flash HT / Flash HT plus / IRMS	19003750
X1116	NC 1000 an. kit, Flash HT / HT plus (TF Bremen p/n 129 3160)	19003780
X1130	Sulfur-kit, FlashEA 1112 / 2000/Flash HT	1157110
X1131	Consumables, FlashEA/Flash HT, NCS-analysis (1000 analyses)	1293140
X1134	Consumables, Flash HT, NC-analysis (1000 analyses)	1293160
X1135	Spares & Consumables, Flash HT, NC-analysis (3000 analyses)	1293170
X1138	Consumables, Flash HT and TC/EA, OH-analysis (1000 analyses)	1290340
X1139	Kit for 8000 analyses, Flash for IRMS / HT NCS analysis	
X7008	Reactor kit, Flash HT	1197480
E5010	TOC (total organic carbon) kit	19004128

Thermo Fisher Scientific® Flash 2000

Part No	Description	Thermo Fisher Scientific® part
X1050	Flash EA1112 consumables, Package A for solid samples	
X1053	Consumables kit (1000 analyses) Flash1112 CHNS	
X1054	Consumables kit (1000 analyses) EA1112 CHNS & O	
X1055	Consumables kit (1000 analyses) EA1112 NC Soils	
X1056	Consumables kit (1000 analyses) EA1112 NCS	
X1057	Consumables kit (1000 analyses) EA1112 CHN	
X1080	Consumables kit 1000 analysis, FlashEA1112 CHN	19002410
X1081	Consumables kit 1000 analysis, FlashEA1112 CHNS/NCS/S empty tubes	19002411
X1082	Consumables kit 1000 analysis, EA1112 CHNS/NCS/S Prepacked tubes	19002412
X1083	Consumables kit 1000 analysis, Flash EA1112 oxygen	19002416
X1093	Conv kit FlashEA NC to NCS detection	19004245
X1130	Sulfur kit, FlashEA 1112 / 2000/Flash HT	1157110
X1131	Consumables, FlashEA/Flash HT, NCS-analysis (1000 analyses)	1293140
X1132	Spares & consumables, FlashEA NC-analysis (3000 analyses)	1142961
X1133	Consumables, FlashEA, NC-Analysis (1000 analyses)	1293150
X3211	Kit 1000 analyses, NC Flash1112	1142960
X7004	Package A for solid sample, Flash 2000	19004220
X7005	Package B for solid sample, Flash 2000	19004225

Liners/inserts/ash fingers/crucibles (by size/shape)

Liners, inserts, ash fingers, or crucibles typically all perform the same function; enabling the simple removal of residual ash, they can prolong the useful life of your combustion tube, and help ensure your sample is positioned at the correct height in the furnace.

Given the comparative cost of combustion tubes and reagents, using an ash finger (which can be replaced whenever necessary) will ensure your laboratory gets as many analyses as possible from every tube.

This guide, organized by size/shape of insert, and by material, can help you find the right ash fingers, liners, inserts and crucibles from our extensive product range.

Open both ends, quartz

O.D./mm	Length/mm	Pack	Part No	Description
13	70	1	C1156	Quartz crucible
13	200	2	C1129	Quartz liner for 18 mm reactor (200 mm)
13	205	1	C1090	Sleeve insert, transparent silica
13	205	5	C1135	Sleeve insert, transparent silica
13	220	1	C1096	Sleeve insert, transparent silica
13	220	2	C1125	Quartz insert for 18 mm reactor (220 mm)
13	220	5	C1098	Sleeve insert, transparent silica
13	230	1	C1120	Quartz liner
13	230	5	C1127	Quartz liner
13	235	1	C1093	Sleeve insert, transparent silica
13	235	2	C1128	Quartz liner for 18 mm reactor (235 mm)
13	245	2	C1124	Quartz liner for 18 mm reactor (245 mm)
13	250	1	C1123	Sleeve insert, transparent silica
15	180	1	C1050	Sleeve insert, transparent silica
15	205	5	C1136	Quartz insert
15	220	1	C1094	Sleeve insert, transparent silica
15	240	5	C1145	Quartz insert
19.5	100	1	C2025	Slitted sleeve, transparent silica, 2400 series
20	70	1	C1131	Turbo N/Dumatherm (r) quartz insert
22	60	5	C3018	Ash finger, quartz
22	60	10	C3060	Ash finger, quartz
28	100	1	C4802	Upper quartz crucible CKIC TCN/CHN2200



Open both ends, other materials

O.D./mm	Length/mm	Pack	Part No	Description	Material
11.3	330	1	D6001	Receptacle insert CHN rapid	Nickel
12.5	250	1	D6005	Swarf crucible NA2000/2100	Stainless steel
12.7	225	1	F5177	Swarf crucible no tabs	Inconel
18	250	1	D6050	HPAR crucible Flash EA 1112	Inconel
18	250	1	F5153	Reactor crucible Flash EA1112	Inconel
24	60	1	C3030	Ash finger rapid N	Ceramic



Liners/inserts/ash fingers/crucibles (by size/shape)

Closed one end, quartz

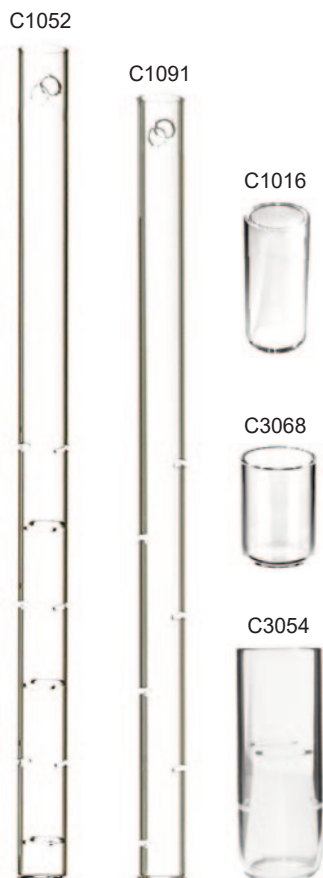

O.D./mm	Length/mm	Pack	Part No	Description
7	17	5	C1004	Swarf crucible transparent silica
7	35	5	C1005	Swarf crucible transparent silica
12	33	24	C4506	Quartz crucible
12.4	225	1	C3020	Pyrolysis tube insert vario-EL
13	30	5	C1016	Swarf crucible 30 x 13 mm, silica for C1069/C1072/C1078
13	60	5	C1054	Removable swarf crucible 60 x 13 mm
13	205	1	C1091	Sleeve insert transparent silica
13	210	1	C2032	Sleeve insert CHNS transparent silica EA1108
13	220	1	C1052	Sleeve insert transparent silica
13	235	1	C1051	Sleeve insert transparent silica
13	245	2	C1097	Sleeve insert
13	250	1	C1065	Silica swarf crucible transparent
14	30	5	C1006	Swarf crucible 30 x 14 mm, transp. silica, for C1022/C1024
14	60	5	C1053	Swarf crucible 60 x 14 mm, transparent silica
15	220	1	C2030	Sleeve insert transparent silica NA1500(1)
16	35	5	C1007	Swarf crucible 35 x 16 mm, transparent silica NA1500(1)
17	20	5	C4007	Crucible transparent silica
22	30	1	C3068	Quartz crucible
22.5	60	1	C3054	Ash crucible quartz
22.5	61	1	C3024	Ash finger quartz
22.5	61	10	C3070	Ash finger quartz
25	41	50	C4046	Crucible transparent silica
25	64	50	C4210	Silica (quartz) crucible LECO FP428
25	75	25	C4048	Crucible transparent silica
28	100	1	C4806	Lower quartz crucible CKIC TCN/CHN2200



C7020



E2388



C4073



C4065
C4067

Closed one end, other materials

O.D./mm	Length/mm	Pack	Part No	Description	Material
4.5	30	1	C7012	Crucible for TC/EA	Graphite
5.05	30	1	C7013	Large crucible for TC/EA	Graphite
5.9	30	1	C7014	Extra large crucible for 9 mm ID glassy carbon tubes	Graphite
6	40	1	C7019	Hexagonal crucible for TC/EA	Graphite
7	40	1	C7020	Octagonal crucible for TC/EA for 7 mm ID glassy carbon tubes	Graphite
8	40	1	C7020	Octagonal crucible for TC/EA for 9 mm ID glassy carbon tubes	Graphite
12	170	1	C3061	Ash crucible	Graphite
12	200	1	C7018	Ash finger - high temp. Pyrocube	Glassy carbon
18	15	10	E2388	Micro porous crucible	Ceramic
18	25	10	C4034	Crucible	Ceramic
22.5	60	1	C3063	Ash finger	Stainless steel
22.5	90	1	C3062	Ash finger	Stainless steel
23.5	60	1	C3031	Ash finger	Stainless steel
24.9	60	1	C3065	Ash crucible, rapid N exceed®	Stainless steel
26	41	50	C4039	Crucibles	Ceramic
29.0	106	10	C4071	Large crucible for liquid	Ceramic
29.5	46	5	C4073	Porous crucibles (small)	Ceramic
29.5	102	5	C4067	Porous crucible	Ceramic
29.5	102	10	C4065	Porous crucible	Ceramic

Liners, Inserts & ash crucibles

OEM-specific operating supplies

Elementar® – operating supplies

Part No	Description	Pack	Elementar® part
E1174	Filter, diameter 18 mm	1	03002399
E1174-10	Filter, diameter 18 mm	10	03002399
E2532	Set of ball valve half shells 10 mm	1	15.00-0005
E2533	Set of ball valve half shells 14 mm	1	21.00-0008



Filter, diameter 18 mm
E1174



Set of ball valve
half shells, 10 mm
E2532



Tubing, PTFE, 2 x 1 mm
E2030-2



Fitting for 12 mm trap
E1581

EuroVector – operating supplies

Part No	Description	Pack	EuroVector part
E2149	2 x 1 mm PTFE ferrule	1	P01-017
D6006	Copper rod 140 mm	1	C09-007
E1580	EA3000 12 mm empty trap assembly	1	P01-108
E1581	Fitting for 12 mm trap	1	P01-107
E2350	Scrubbing tube kit for water		E12531
E2030-2	Tubing, PTFE, 2 x 1 mm	2 m	P12-077

LECO® – operating supplies

Part No	Description	Pack	LECO® part
E2199	Lance assembly complete	1	616-147
E2197	Lance holder block	1	783-275
E2198	Lance holder cover	1	783-276
E2235	Secondary (screen) filter	1	775-306



Secondary
(screen) filter
E2235



Lance assembly,
complete,
E2199



Filter discs, glass
E2011

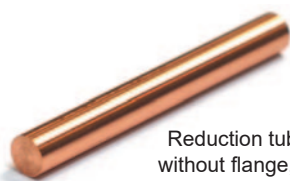

Reduction tube plug
without flange, copper
D6004

PerkinElmer® – operating supplies

Part No	Description	Pack	PerkinElmer® part
E2019	Filter discs, 25 mm	12	N2410237
E2011	Filter discs, glass	12	
D6002	Reduction tube plug with flange, copper	1	
D6004	Reduction tube plug w/o flange, copper	1	
E2101	Retrieving wire	1	
D6000	Vial receptacle nickel	1	
E2051	Zirconia cloth	1	

The use of OEM part numbers is intended for convenience only, and does not imply that the products are of OEM origin. All Elemental Microanalysis products are guaranteed to be of high quality and are deemed to be suitable alternatives in the stated instruments. All OEM trademarks acknowledged.

OEM-specific operating supplies

Thermo Fisher Scientific® – operating supplies

18 mm bottom fittings with tubing and fittings F6200

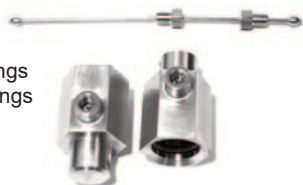

Doping vessel kit chloropentane E2220



Replacement furnace E4410



Piston assembly MAS200R F2224

Part No	Description	Thermo Fisher Scientific® part
F6200	18 mm bottom fittings with tubing and fittings	1
F5165	32A wrench	1 20501610
E2099	Blanking cap brass	1 35036103
F5166	Bottom adapter (kit)	1 34701808
E2096	Connector brass 2 mm 4-way	1 34736100
E2220	Doping vessel kit chloropentane	1
F5163	End fitting adsorption trap connection	1 35008455
E2097	Knurled retaining nut brass	1 35041101
F2224	Piston assembly MAS200R	1 34301512
E2102	Purging valve autosampler slide type	1 40523005
E2069	Recorder pen	1 35265100
E4410	Replacement furnace with adaptors	1 35460022, 35460021, 35460018
F5164	Tool for lower fitting EA	1 20500628
F2225	Tool for replacing o-rings for MAS200R	1
E2034	Tube connector push fit	1 35034108
E2095	Tubing coupling 2 mm stainless steel	1 34739133
F4543	Tubing ferrule for Flash, aluminium, 4 mm	1 29034051
E2350	Scrubbing tube kit water	1 28113100
E2342	Small H ₂ O adsorption filter fittings with o-rings	2
E2362	Syringe 100 µl Hamilton 80665/00	1 36500204
E2365	Syringe 10 µl 80 mm SGE S002124	1 36502019

Tool for replacing o-rings for MAS200R F2225

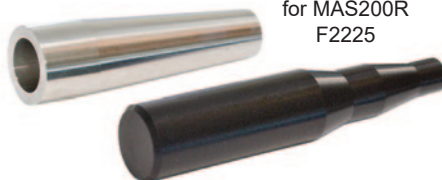

Tubing ferrule F4543



Tube connector push fit E2034



Thermo Fisher Scientific® – vials and septa

Part No	Description	Pack	Thermo Fisher Scientific® part
E2301	Al seal 11 mm PTFE faced septum	100	38606040
E2311	Al seal 20 mm PTFE faced septum	50	38606035
E7609	10 CV vials	5	240 30000
E7610	Complete vials 2SVW	100	24014019
E7612	Screw cap 8-SC	5	38606085
E7606	Screw caps 8-SC	1000	38606073
E7614	Septa for Flash 2000 injector	50	31303230
E7613	Septa for waste bottle	5	31303218
E7611	Vials solvent 4 ml ST 4SVQ	5	24014032
E2310	Vials 10 ml	100	24074020
E2300	Vials 2.5 ml	100	24070005
E2361	Septum liquid injector	50	31303209
E2360	Septum liquid injector	50	31303200



Complete vials 2SVW E7610



Vials solvent 4 ml ST 4SVQ E7611

Septa for Flash 2000 injector E7614



Operating supplies

Operating supplies – general

Part No	Description	Pack
F4506	Aluminium ferrule 2 mm	10
F4540	Aluminium ferrules 1.6 mm (1/16)	10
E2050	Blanking nut, brass	1
E2216	Blanking nut, brass	10
E2036	Blanking nut, stainless steel	1
E2068	Chart paper, Z-fold	2
E2154	Cleaning brush	1
F5113	Cleaning tool	1
E2035	Column fitting, 6 to 2 mm, stainless steel	1
F2401	Cooling fan, 120 mm, 240VAC 18W	1
E4404	Flexible blue tubing, polyurethane, 5x3 mm	3m
E2517	GL14 screw cap	
E2539	GL18 blanking cap, red	2
E2518	GL18 screw cap	
E2521	Manually operated drill	1
E2100	Olive, 2 mm, stainless steel	1
E2150	Pinch valve tubing	sold per ft
E2527	Powder filling funnel (large) with silicone tubing outlet	1
E2526	Powder filling funnel (small) with silicone tubing outlet	1
E2115	PTFE tube, 6 mm x 4 mm	1m
E2158	Silicone grease	100g
F2176	Solenoid valve 4W	1
E2094	Tubing connector, 2 mm	1
F4523	Tubing nuts, 2 mm	10
E2030-2	Tubing, PTFE, 2 x 1 mm	2m
E2030	Tubing, PTFE, 2 x 1 mm	5m
E2211	Tubing, PTFE, 4 x 2 mm	1m
E2213	Tubing, PTFE, 4 x 2 mm	5m
E1058	Tubing, PTFE, 5 mm OD x 3 mm ID	0.5m
E2033	Tubing, stainless steel, 2 x 1 mm	3m

Aluminium ferrule, 2 mm
F4506



Blanking nut, brass
E2050, E2216



Flexible tubing,
polyurethane 5x3 mm
E4404



Cleaning brush
E2154

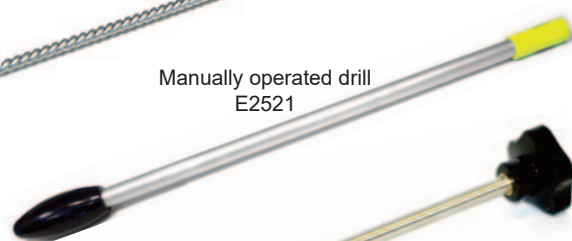

Manually operated drill
E2521



Cleaning tool
F5113



Powder filling funnel (small)
with silicone tubing outlet
E2526



Tubing, PTFE,
2 x 1 mm
E2030



Tubing, stainless steel, 2 x 1 mm
E2033

Column fitting, 6 to 2 mm, stainless steel
E2035

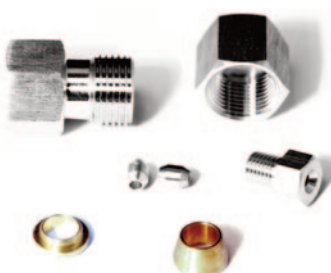

Solenoid
valve, 4W
F2176

Separation columns

Part No	Description	EuroVector®	NC Technologies (Costech)	Thermo Fisher Scientific®	Sercon®
E3000	Separation column, CHN, 2 m stainless steel		051081	26008200	SC1991
E3001	Separation column, oxygen, 1 m stainless steel		051084	26007900	SC1992
E3002	Separation column, sulfur, 0.8 m PTFE		051083	26007800	SC1993
E3003	Separation column, CHNS NCS, 2 m stainless steel		051080	26008206	SC1994
E3004	Separation column, NC/NCS, 3 m stainless steel		051082	26008205	SC1995
E3006	Separation column, CHN, 2 m stainless steel			26008000	SC1998
E3007	Separation column, trace sulfur, 0.5 m PTFE			26018500	SC1998
E3008	Separation column, NC 4 m stainless steel		051085		SC1999
E3013	Separation column, CHNS, 2 m PTFE			26008208	SC2003
E3015	Separation column, CHNS, 2.5 m stainless steel				SC2005
E3016	Separation column, oxygen, 2 m stainless steel		051088		SC2006
E3020	Separation column, CHN, 2 m PTFE			26008207	SC2007
E3023	Separation column, SS			26007920	
E3024	Separation column, PTFE, 2 m			26008220	
E3025	Separation column, NC, semi-macro 2 m PTFE				SC2009
E3034	Separation column, 0.8 m 1/4" sulfur column				
E3038	Separation column, CHNS, 2 m PTFE			26008215	SC2340
E3039	Separation column, 6 x 4 PTFE 0.15 m			26007801	
E3045V	GC column, SS - 2 m 6 x 5 mm (CHNS) (1 pcs)	C10-028			
E3046V	GC column, PTFE - 1 m-CHNS	C10-168			
E3047V	GC column, PTFE - 2 m-CHNS	C10-170			
E3049V	GC column, PTFE - 1 m - 8 x 6 mm (CHNS) (1 pcs)	C10-030			
E3050V	GC column, SS - 1.5 m - 6 x 5 mm for (O-H)	C10-187			
E3051V	GC column, SS - 1.5 m - 6 x 5 mm for (O-H)(H)(O) (1 pcs)	C10-033, E11521			

Separation columns that are specifically for CF-IRMS are listed on p 75



Separation column
CHNS, NCS 2m
stainless steel
E3003

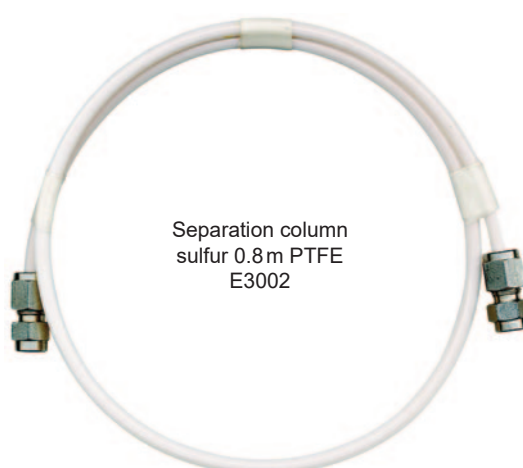

Separation column
sulfur 0.8 m PTFE
E3002

Tools and accessories

Forceps

D7010	Forceps, platinum tipped - length 130 mm
E2016	Forceps, stainless steel, curved points - length 130 mm
E2017	Forceps, stainless steel, straight points - length 130 mm
E2018	Forceps, stainless steel, blunt points - length 130 mm
E2293	Forceps - overall length 145 mm
E2294	Forceps, stainless steel, blunt points, smooth jaw - length 130 mm

D7010
E2016
E2017
E2018
E2293
E2294

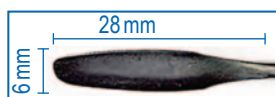
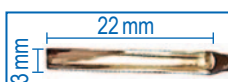

E2000

E2290

E2291

E2292

E2462

F5103

F5104

F5108

Spatulas

E2000	Spatula, stainless steel 150 x 3 mm
E2290	Spatula, micro, single-ended
E2291	Spatula, micro spoon, formed, bent
E2292	Spatula, micro spoon
E2462	Spatula
F5103	Spatula
F5104	Spatula (left-handed)
F5108	Large spatula for NA2000



E2105

Absorbent discs

Absorbent materials for use when preparing liquid samples in pressed capsules.

Part No	Description	Pack
E2105	Absorbent discs 3.5 mm	100
E2108	Absorbent discs 5 mm	100
E2110	Absorbent/filter discs 8 mm	100
E2107	Absorbent discs 10 mm	100

Multiwell plates and seals

Multiwell plates are used to store weighed samples prior to analysis. Using a silicone seal for the 96-cell plate will help prevent cross-contamination if samples leak during transport, as it seals each well.

Part No	Description	cell diam/mm	Pack
E2066	Multiwell plate, 6 cell flat bottom	35	1
E2065	Multiwell plate, 12 cell flat bottom	21	1
E2064	Multiwell plate, 24 cell flat bottom	10	1
E2063	Multiwell plate, 48 cell flat bottom	7	1
E2044	Multiwell plate, 96 cell flat bottom	7	1
E2062	Multiwell plate, 96 cell round bottom	7	1
E2079	Multiwell plate, 96 cell flat bottom, bulk pack	7	10
E2278	Silicone seal for 96 cell multiwell plate (1 seal)	—	1
E2279	Silicone seal for 96 cell multiwell plate, bulk pack	—	10

E2044

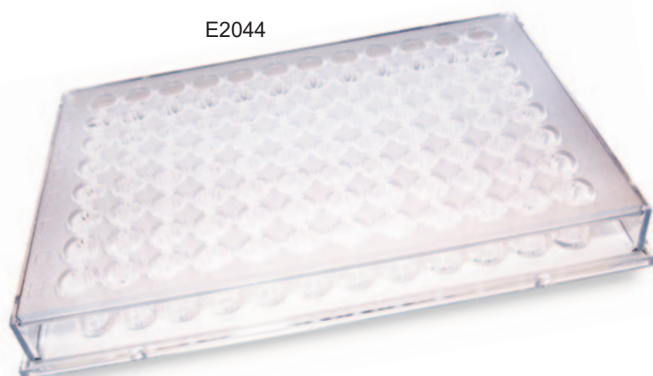

Tools and accessories

Sealing devices



Sealing device
F5112

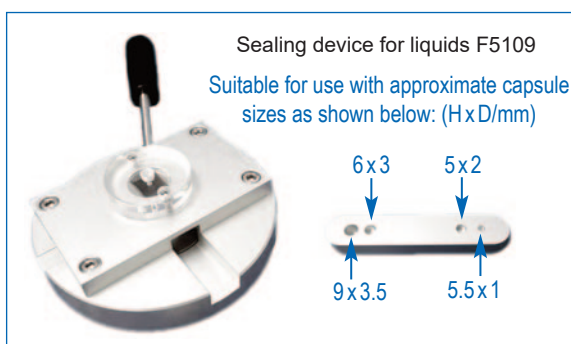

Mole grips, miniature
E2043

Manual sample presses

Available in four sizes, our compact, high quality manual presses produce uniform compressed sample pellets with ease. They can be used with flat foils, cone foils, boats or capsules.

E2534 Manual press, 5 mm pellet diam.
E2535 Manual press, 7 mm pellet diam.

E2536 Manual press, 9 mm pellet diam.
E2537 Manual press, 10.5 mm pellet diam.

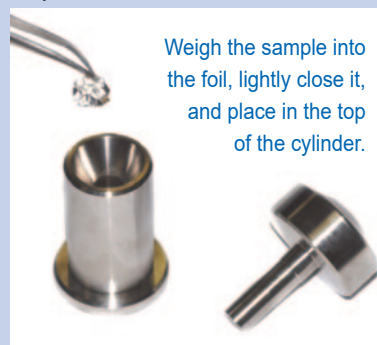

Sample preparation kits

Part No	Description
X5010	Sample preparation kit - contains 1000 capsules, 10 x 96 multiwell plates with silicone seals
X5153	Solid sample preparation kit
X5152	Solid sample preparation kit inc. manual press 5 mm pellet diameter



Miscellaneous supplies

Part No	Description	Pack
E2471	Crucible tongs - overall length 250 mm	1
E2041	Drill, 6.5 mm, tungsten carbide tipped 400 mm	1
E2104	Flexible clear tubing, 4 x 2.5 mm x 5 m	5 m
E2505	Gloves	1 pair
C1144	Long stem filling funnel	1
E2045	Micro-pipette filler	1
E2009	Micro-pipettes, 25 microlitre, borosilicate	250
E2008	Micro-pipettes, 5 microlitre, borosilicate	250
E2039	Snoop leak detection fluid, 236 ml/8 fluid oz	1
E2042	Tee bar ratchet	1
E2240	Vacuum grease	50g



Oxygen flask combustion equipment

Oxygen flasks

Our oxygen flasks conform to BS2735 and are available in borosilicate or silica glass. We can manufacture oxygen flask in other designs if required. Please enquire for more details.

Part No	Description
E2022	Oxygen flask, borosilicate, 250 ml, B24
E2070	Oxygen flask, borosilicate, 250 ml, B29
E2023	Oxygen flask, borosilicate, 500 ml, B24
E2071	Oxygen flask, borosilicate, 500 ml, B29
E2106	Oxygen flask, borosilicate, 500 ml, B34
E2080	Oxygen flask, borosilicate, 750 ml, B29
E2072	Oxygen flask, borosilicate, 750 ml, B29, for use with Hereaus combustion unit
E2103	Oxygen flask, silica, 1000 ml, B29
E2073	Oxygen flask, silica, 250 ml, B24
E2074	Oxygen flask, silica, 250 ml, B29
E2026	Oxygen flask, silica, 500 ml, B24
E2027	Oxygen flask, silica, 500 ml, B29
E2093	Oxygen flask, silica, 750 ml, for fluorine determination

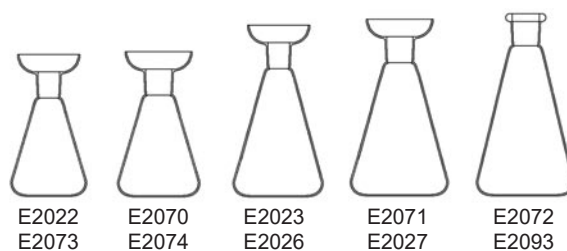

Oxygen flask stoppers

Part No	Description
E2024	Stopper, borosilicate, B24, with hook
E2081	Stopper, borosilicate, B29, with hook
E2028	Stopper, silica, B24, with hook
E2029	Stopper, silica, B29, with hook

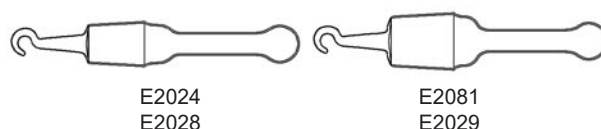

Gelatin capsules

Gelatin capsules are used mainly in oxygen flask combustion.

Description	Pack	Part No
Gel capsules 5 x 15 mm	100	E2021
Gel capsules 5.5 x 17 mm, size 3	100	E2141
Gel capsules 6 x 19 mm, size 2	100	E2142
Gel capsules 6.5 x 21 mm, size 1	100	E2143
Gel capsules 7 x 23 mm, size 0	100	E2144
Gel capsules 8 x 25 mm, size 00	100	E2145
Gel capsules 9 x 27 mm, size 000	100	E2146
Gel capsules 9 x 27 mm, size 000	1000	E2147

Other oxygen flask combustion accessories

Part No	Description	Pack
E2014	Filter paper roll for paper flags	30 mm x 100 m
D7010	Forceps, platinum tipped	1
E2076	Safety gloves, Kevlar	1 pair
E2075	Safety screen, polycarbonate	1

Safety gloves, Kevlar
E2076



Platinumware

Platinum baskets and platinum flags are of fully welded construction, in 99.9% platinum. Edges and rims are folded and welded to reduce fraying.

Part No	Description
D7007	Platinum basket for inverted flask, 20 x 7 mm basket, 70 x 1 mm stem
D7016	Platinum basket for upright flask, 10 x 7 mm basket, 110 x 1 mm stem
D7005	Platinum basket for upright flask, 20 x 7 mm basket, 70 x 1 mm stem
D7017	Platinum flag, 15 x 20 mm flag, 70 x 1 mm stem
D7004	Platinum flag, 15 x 30 mm flag, 70 x 1 mm stem
D7006	Platinum gauze, 225 mesh, 12 x 150 mm
D7014	Platinum gauze, 225 mesh, 20 x 200 mm
D7012	Platinum sheet, 50 x 50 x 0.05 mm
D7013	Platinum sheet, 50 x 50 x 0.1 mm
D7015	Platinum wire, 150 x 1 mm

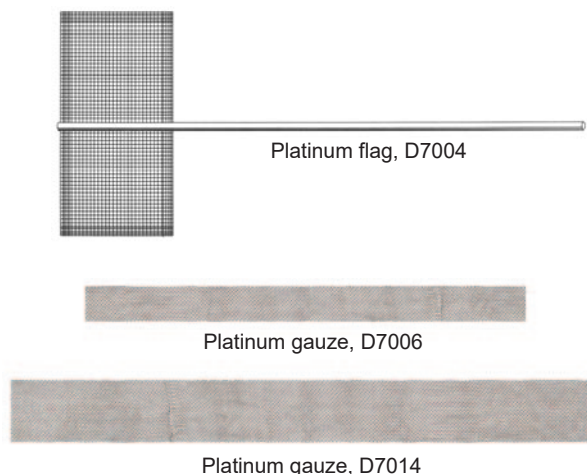

Configuration guide

for MICRO CHNOS analysis

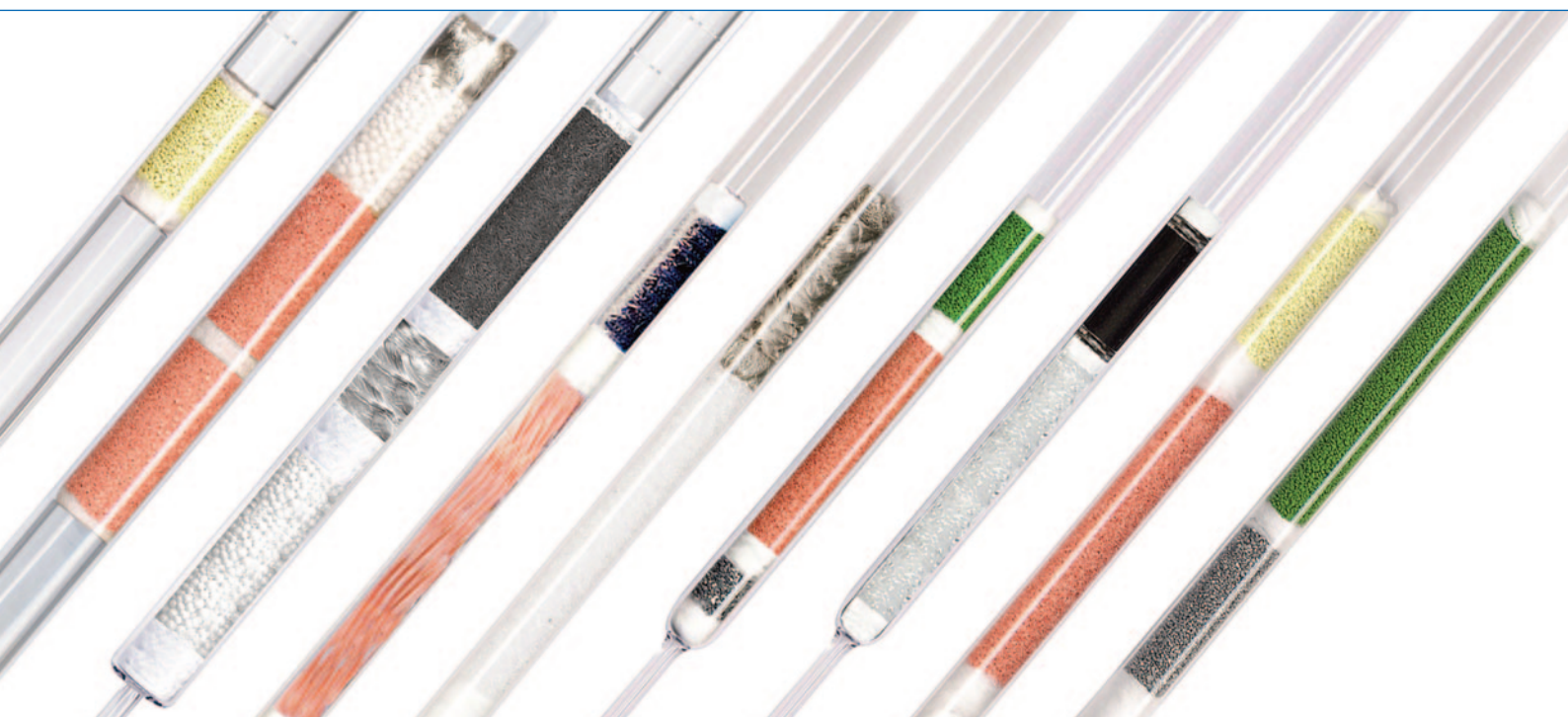

Elementar® UNICUBE/vario EL cube/vario Micro cube/vario ISOTOPE cube/vario ISOTOPE select

CHN/CN/N mode

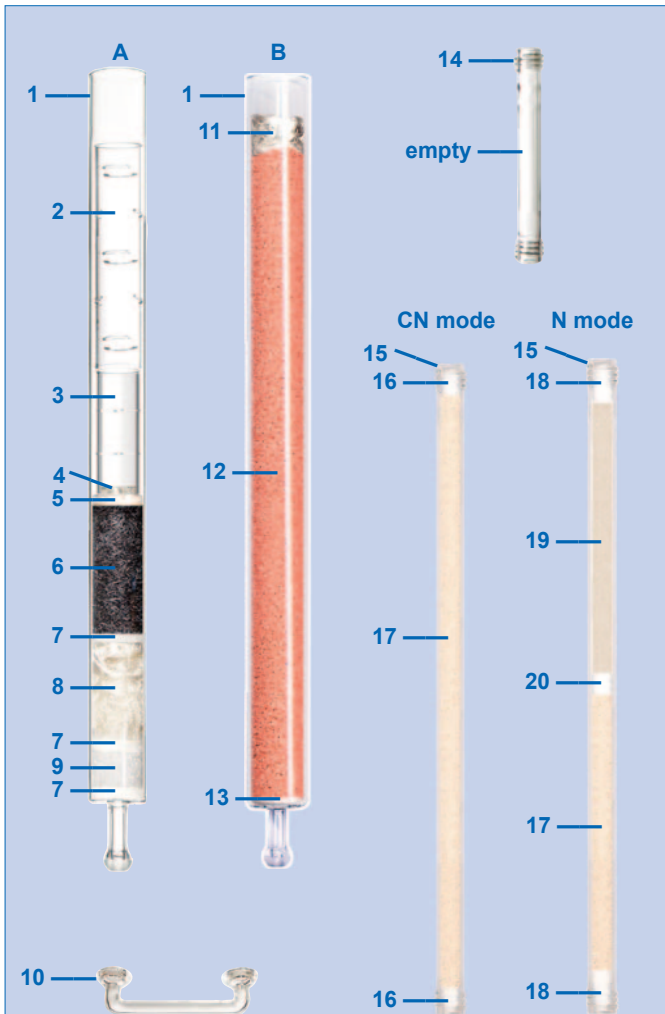

CHNS/CNS mode

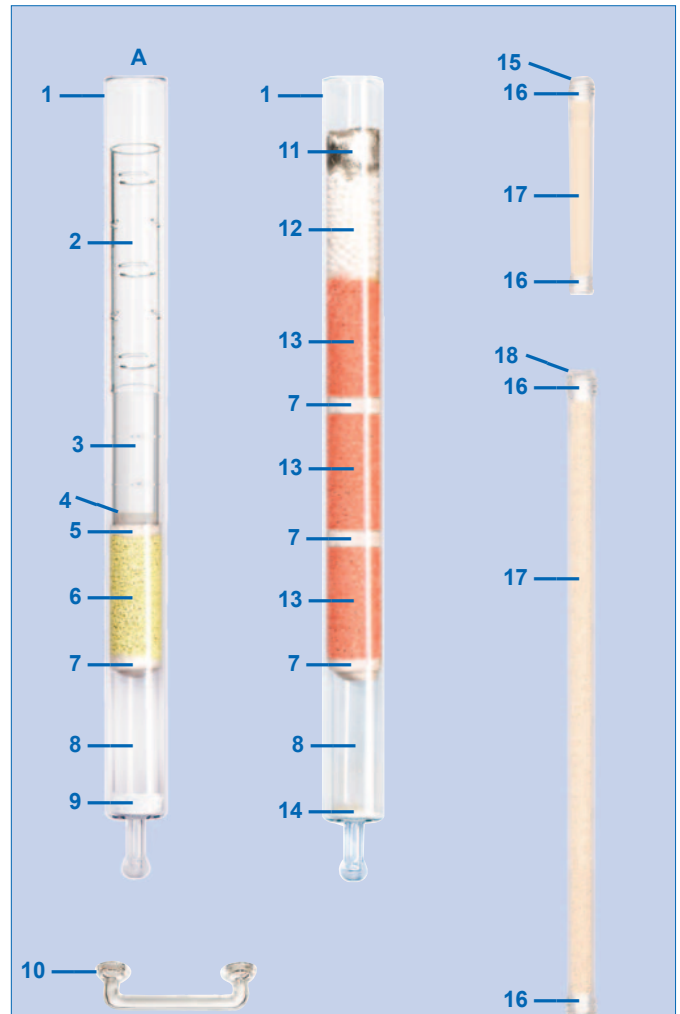

Key

Product	Qty	OEM No.	Part No.
1 Combustion/reduction tube		11.00-1150/4	C3009
2 Protective tube, 105 mm		11.00-1317/4	C3021
3 Ash finger, quartz		11.00-1170/4	C3018
4 Alumina wool (in bottom of ash finger)	10 mm	05 000 086	B1089
5 Alumina spheres	3 mm	50 008 467	B1093
6 Copper oxide wires, fine	63 mm	05 001 039	B1122
7 Quartz wool	5 mm	03 679 908	B1102
8 Silver wool	50 mm	22 131 365	B1231
9 Silica chips	18 mm	03 679 907	B1214
10 Connecting tube 65 mm		11.00-1331/4	C3022
11 Silver wool	20 mm	22 131 365	B1231
12 Copper wires	296 mm	05 000 699	B1015M
13 Quartz wool	5 mm	03 679 908	B1102
14 Drying tube		22 160 204/4	C3008
15 Drying tube 300 mm		15.00-0080	C1143
16 Cotton wool	10 mm	05 001 715	E2516
17 Dessicant* as appropriate according to application			
18 Cotton wool	20 mm	05 001 715	E2516
19 EMASorb II A granular	115 mm	03 679 900	B1322
20 Quartz wool	10 mm	03 679 908	B1102

A Prepacked N/NC/CHN reaction tube X2506
NB Does not include quartz liner/ash finger - please purchase items 2 & 3 separately
B Prepacked N/NC/CHN reduction tube X2500

Key

Product	Qty	OEM No.	Part No.
1 Combustion/reduction tube		11.00-1150/4	C3009
2 Protective tube, 105 mm		11.00-1317/4	C3021
3 Ash finger, quartz		11.00-1170/4	C3018
4 Alumina wool (in bottom of ash finger)	10 mm	05 000 086	B1089
5 Alumina spheres	3 mm	50 008 467	B1093
6 Tungsten (VI) oxide granular	55 mm	11.02-0008	B1217
7 Quartz wool	10 mm	03 679 908	B1102
8 Support tube 65 mm		11.00-1172/4	C3017
9 Quartz wool	15 mm	03 679 908	B1102
10 Connecting tube 65 mm		11.00-1331/4	C3022
11 Silver wool	25 mm	22 131 365	B1231
12 Alumina spheres	45 mm	50 008 467	B1093
13 Copper wires	50 mm	05 000 699	B1015M
14 Quartz wool	5 mm	03 679 908	B1102
15 Drying tube		22 160 204/4	C3008
16 Cotton wool	10 mm	05 001 715	E2516
17 Dessicant* as appropriate according to application			
18 Drying tube 300 mm		15.00-0080	C1143

A Prepacked CNS/CHNS reaction tube X2505

* Contact us for our recommendations on the most appropriate dessicant.

Elementar® vario PYRO cube

CN/N mode

CNS mode

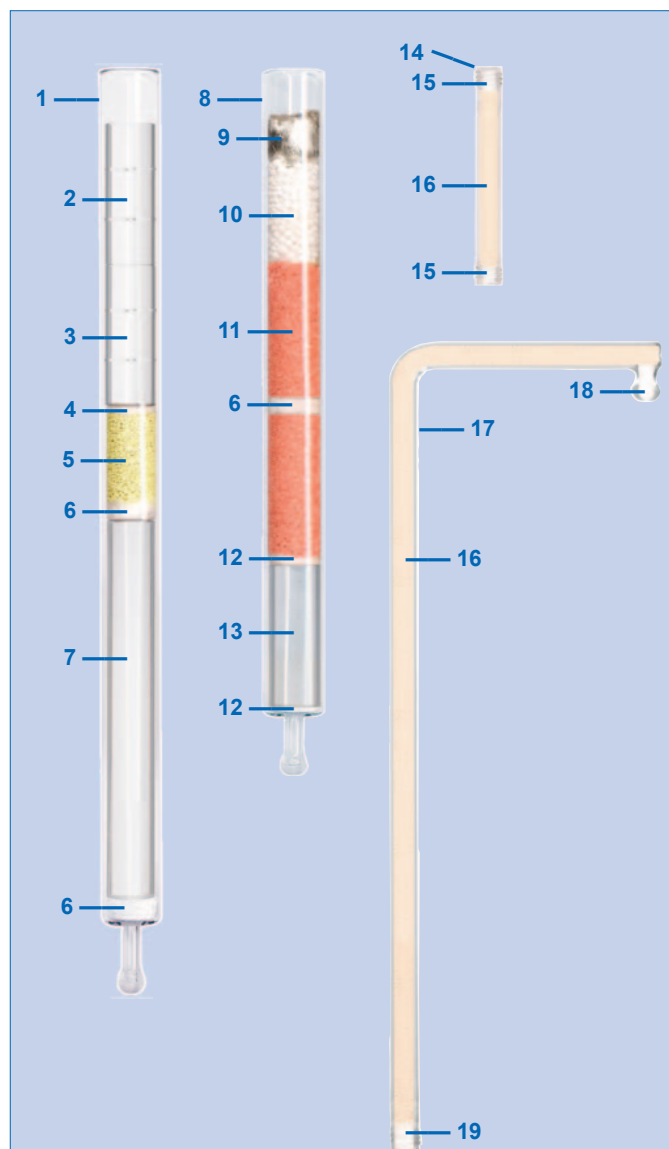
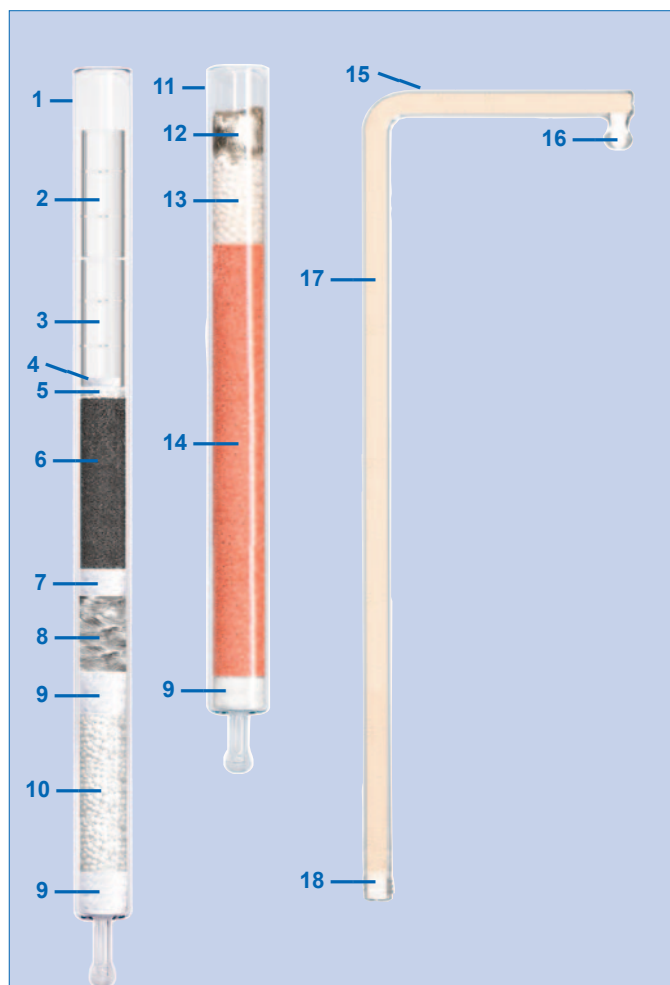

Key

Product	Qty	OEM No.	Part No.
1 Combustion tube		23.00-1150	C3051
2 Protection tube (empty ash finger)		11.00-1170/4	C3018
3 Ash finger, quartz		11.00-1170/4	C3018
4 Alumina wool (in bottom of ash finger)	5 mm	05 000 086	B1089
5 Alumina spheres	3 mm	50 008 467	B1093
6 Copper oxide wires, fine	80 mm	05 001 039	B1122
7 Quartz wool	15 mm	03 679 908	B1102
8 Silver wool	35 mm	22 131 365	B1231
9 Quartz wool	20 mm	03 679 908	B1102
10 Alumina spheres	70 mm	50 008 467	B1093
11 Reduction tube		23.00-1149	C3050
12 Silver wool	25 mm	22 131 365	B1231
13 Alumina spheres	40 mm	50 008 467	B1093
14 Copper wires	205 mm	05 000 699	B1015M
15 Absorbion tube		23.00-1230	C3125
16 Quartz wool	fill bore of ball	03 679 908	B1102
17 Dessicant* as appropriate according to application			
18 Cotton wool	20 mm	05 001 715	E2516

* Contact us for our recommendations on the most appropriate dessicant.

Key

Product	Qty	OEM No.	Part No.
1 Combustion tube		23.00-1150	C3051
2 Protection tube (empty ash finger)		11.00-1170/4	C3018
3 Ash finger, quartz		11.00-1170/4	C3018
4 Alumina spheres	3 mm	50 008 467	B1093
5 Tungsten (VI) oxide granular	40 mm	11.02-0008	B1217
6 Quartz wool	10 mm	03 679 908	B1102
7 Support rod 175 mm		23.00-1148	C3052
8 Reduction tube		23.00-1149	C3050
9 Silver wool	25 mm	22 131 365	B1231
10 Alumina spheres	45 mm	50 008 467	B1093
11 Copper wires	63 mm	05 000 699	B1015M
12 Quartz wool	5 mm	03 679 908	B1102
13 Support rod 65 mm		11.00-1364/4	C3053
14 Drying tube		22 160 204/4	C3008
15 Cotton wool	10 mm	05 001 715	E2516
16 Dessicant* as appropriate according to application			
17 Absorbion tube		23.00-1230	C3125
18 Quartz wool	fill bore of ball	03 679 908	B1102
19 Cotton wool	20 mm	05 001 715	E2516

EuroVector EA3100 & EA3000

CHN mode

CHNS mode

O pyrolysis mode

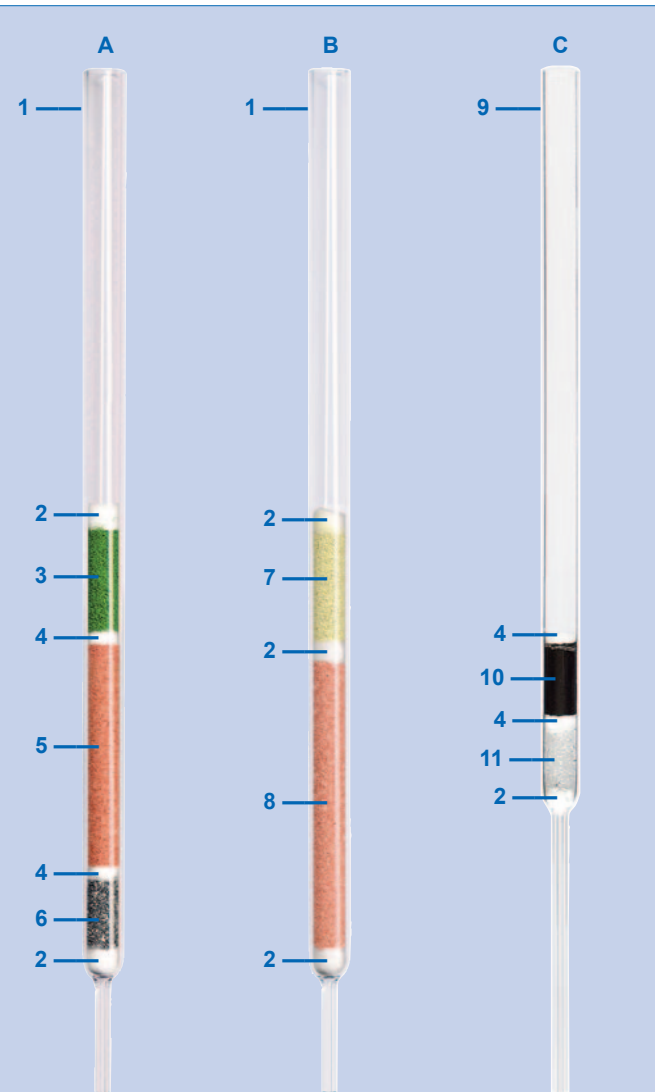

Key

Product	Qty	OEM No.	Part No.
1 Reaction tube		C10-059	C1074
2 Quartz wool, very fine	10 mm	C10-017	B1017
3 Chromium oxide granular	45 mm	C10-001	B1004
4 Quartz wool, very fine	5 mm	C10-017	B1017
5 Copper wires, coarse	100 mm	C10-004	B1016
6 Cobaltous(ic) oxide silvered	30 mm	C10-009	B1000
7 Tungstic oxide	45 mm	C10-007	B1025
8 Copper wires, coarse	125 mm	C10-004	B1016
9 Modified quartz reactor 18/6		C10-071	C1155
10 Nickelised carbon 30% Ni, granular	30 mm	C10-006	B1454
11 Silica (quartz) chips granular	25 mm	C10-016	B1271

A	Prepacked reactor for CHN	C10-169	X1267V
B	Prepacked tube for CHNS	C10-161	X1077V
C	Prepacked oxygen pyrolysis tube	C10-185	X1078

EuroVector EA3100

CN dual tube mode

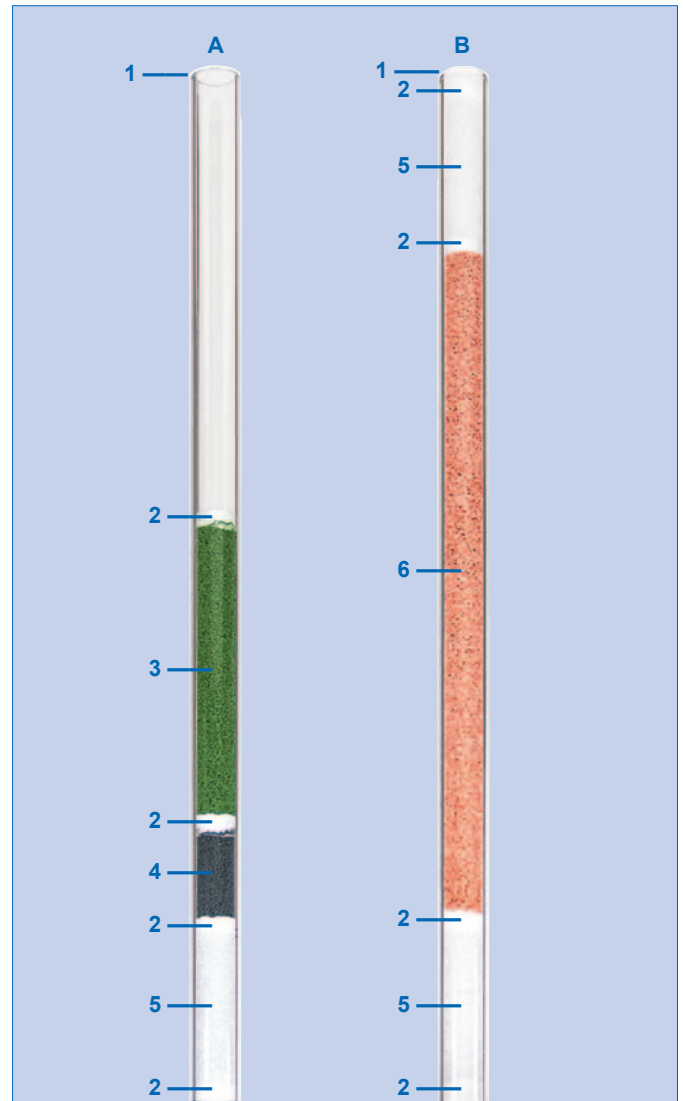

Key

Product	Qty	OEM No.	Part No.
1 Reaction tube		C09-012	C1099
2 Quartz wool, very fine	10 mm	C10-017	B1017
3 Chromium oxide granular	125 mm	C10-001	B1004
4 Cobaltous(ic) oxide silvered	30 mm	C10-009	B1000
5 Silica (quartz) chips granular	65 mm	C10-016	B1271
6 Copper wires, coarse	280 mm	C10-004	B1016

A	Prepacked reactor for CN, combustion,	C10-191	X1248V
B	Prepacked reactor for CN, reduction	C10-192	X1249V

Elemental Microanalysis is the approved manufacturer and supplier of EuroVector consumables.

LECO® TruSpec Micro

CHN/CHNS

Alternative packing for furnace tube

(7 used for CHNS only)

Key				
Product	Qty	OEM part	Part No.	
1 Combustion tube		619-065	C4338	
2 Directing middle tube		619-777	C4358	
3 Reagent tube		619-776	C4364	
4 Copper wires	100 g	502-705	B1015M	
5 Copper turnings	19 mm	501-621	B1136	
6 Porous crucible		614-961-110	C4065	
7 Micro porous crucible (CHNS only)		502-489	E2388	
8 Copper oxide fine wires	15-18 g	502-190	B1125	
9 Quartz wool strip	2	608-379	B1192	
10 Porous crucible (small)		625-511-154	C4073	
11 Reagent tube		619-268	C4341	
12 Glass wool	13 mm	763-265	B1166	
13 EMASorb II A granular	½ tube	502-174	B1316	
14 EMADrone magnesium perchlorate	½ tube	501-171	B1161	
15 Screen filter		775-306	E2235	
16 Reagent tube		617-548	C4332	
17 Quartz reduction tube		619-154	C4339	
18 Copper wires	185 mm	502-189	B1015M	
19 Copper turnings	5 mm	501-621	B1136	
20 Nitrogen catalyst pellets	45 mm	502-049	B1061	
21 Copper turnings	25 mm	501-621	B1136	
A Prepacked reduction tube			X3000	

CHNS mode

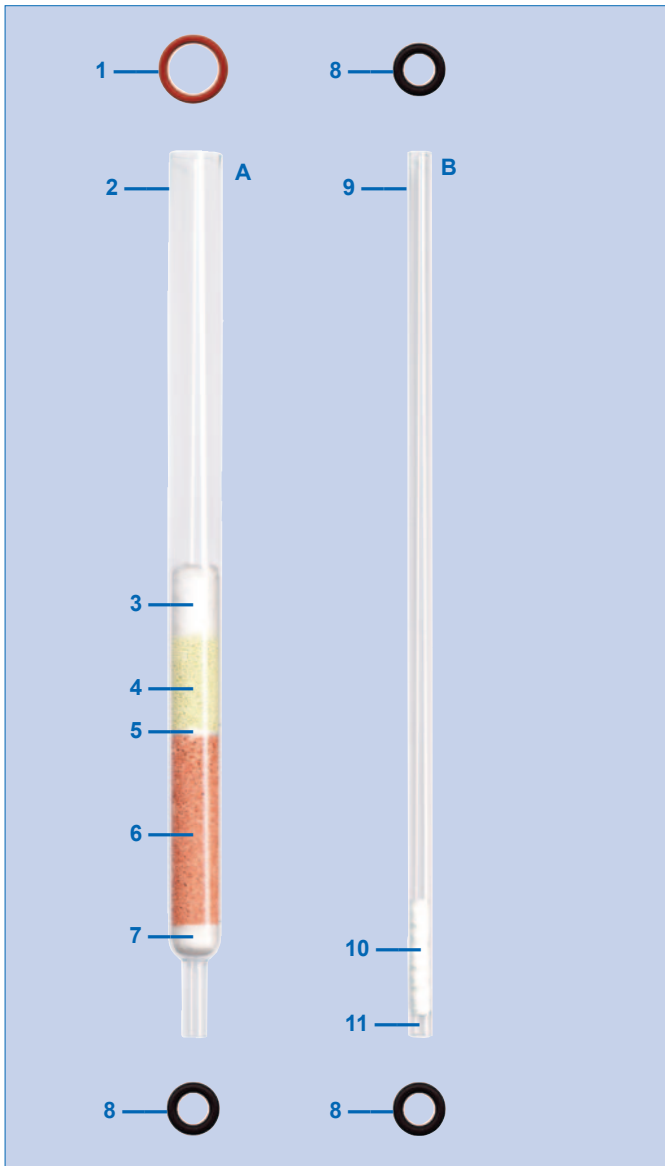

CHN mode

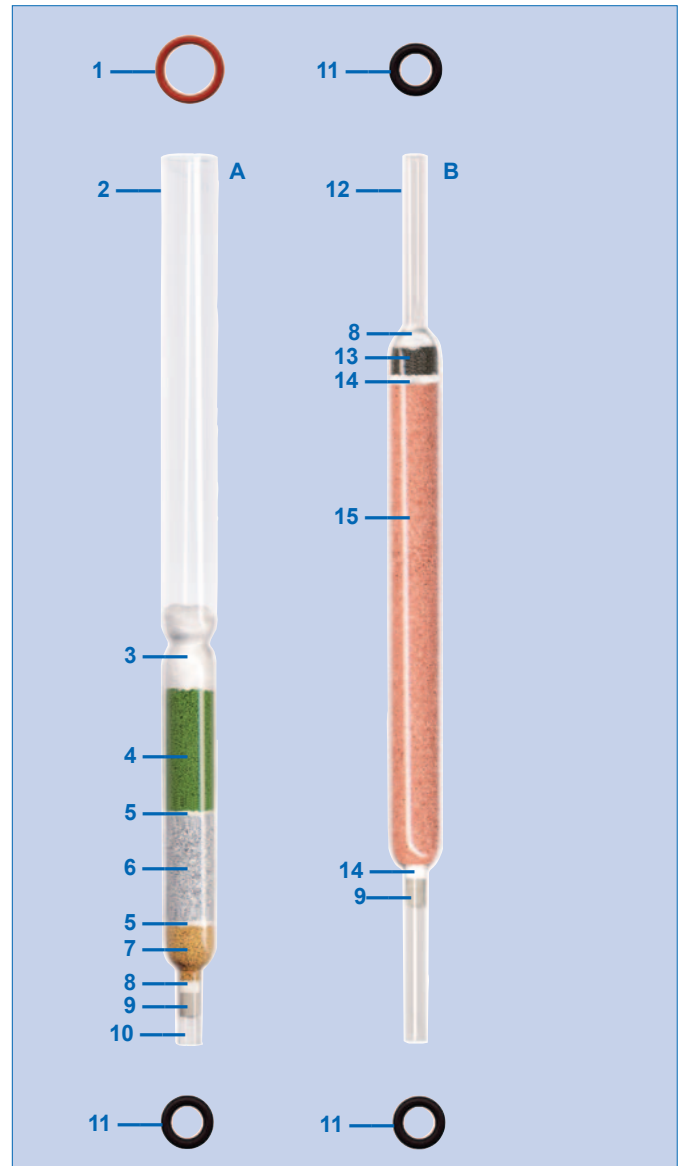

Key

Product	Qty	OEM No.	Part No.
1 O-ring silicone rubber		0990-2188	E1009
2 Combustion tube for CHNS		N241-1514	C2024
3 Quartz wool	32 mm	0240-1118	B1102
4 Tungstic oxide	38 mm	N241-0278	B1025
5 Quartz wool	2 mm	0240-1118	B1102
6 Copper wires, fine	95 mm	0240-1362	B1083
7 Quartz wool	19 mm	0240-1118	B1102
8 O-ring		0240-1583	E1013
9 Quartz reduction tube		N241-1300	C2019
10 Quartz wool	51 mm	0240-1118	B1102
11 No packing	13 mm		
<hr/>			
A Prepacked reaction tube CHNS		N2410693	X2002
B Oxygen reduction furnace tube		N241-0698	X2005

Key

Product	Qty	OEM No.	Part No.
1 O-ring silicone rubber		0990-2188	E1009
2 Combustion tube for CHN		N241-1264	C2015
3 Quartz wool	38 mm	0240-1118	B1102
4 Nickel oxide with chromium oxide	51 mm	0241-0092	B1260
5 Quartz wool	2 mm	0240-1118	B1102
6 Silver tungstate on magnesium oxide	51 mm	0240-1344	B1036
7 Silver vanadate	25 mm	0240-1117	B1009
8 Quartz wool	6 mm	0240-1118	B1102
9 Silver gauze	13 mm	N241-0145	B1037
10 No packing	13 mm		
11 O-ring		0240-1583	E1013
12 Reduction tube for CHN		N241-1291	C2016
13 Copper oxide wires, fine	13 mm	0240-1092	B1122
14 Quartz wool	3-4 mm	0240-1118	B1102
15 Copper granules	225 mm	0240-0117	B1084
<hr/>			
A Prepacked combustion tube CHN		N2410695	X2000
B Prepacked reduction tube CHN		N2410694	X2001

PerkinElmer® 2400

O mode

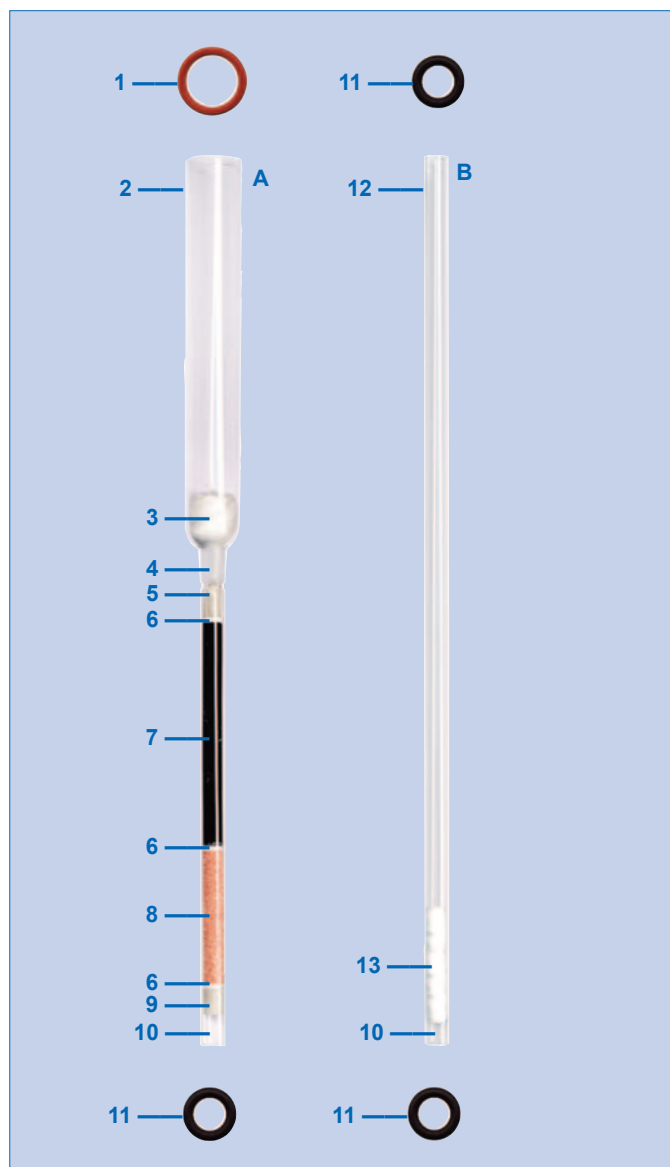

Product	Qty	OEM No.	Part No.
1 O-ring silicone rubber		0990-2188	E1009
2 Pyrolysis tube		N241-1235	C2018
3 Quartz wool	19 mm	0240-1118	B1102
4 No packing	15 mm		
5 Platinum gauze	13 mm	N241-1273	D7006
6 Quartz wool	2 mm	0240-1118	B1102
7 Platinised carbon	102 mm	0240-0119	B1005
8 Copper wires		0240-1362	B1249
9 Silver gauze	13 mm	N241-0145	B1037
10 No packing	13 mm		
11 O-ring		0240-1583	E1013
12 Quartz reduction tube		N241-1300	C2019
13 Quartz wool	51 mm	0240-1118	B1102
<hr/>			
A Prepacked oxygen pyrolysis tube		N241-0696	X2003
B Oxygen reduction furnace tube		N241-0698	X2005

Thermo Fisher Scientific® Flash series

CHN determination

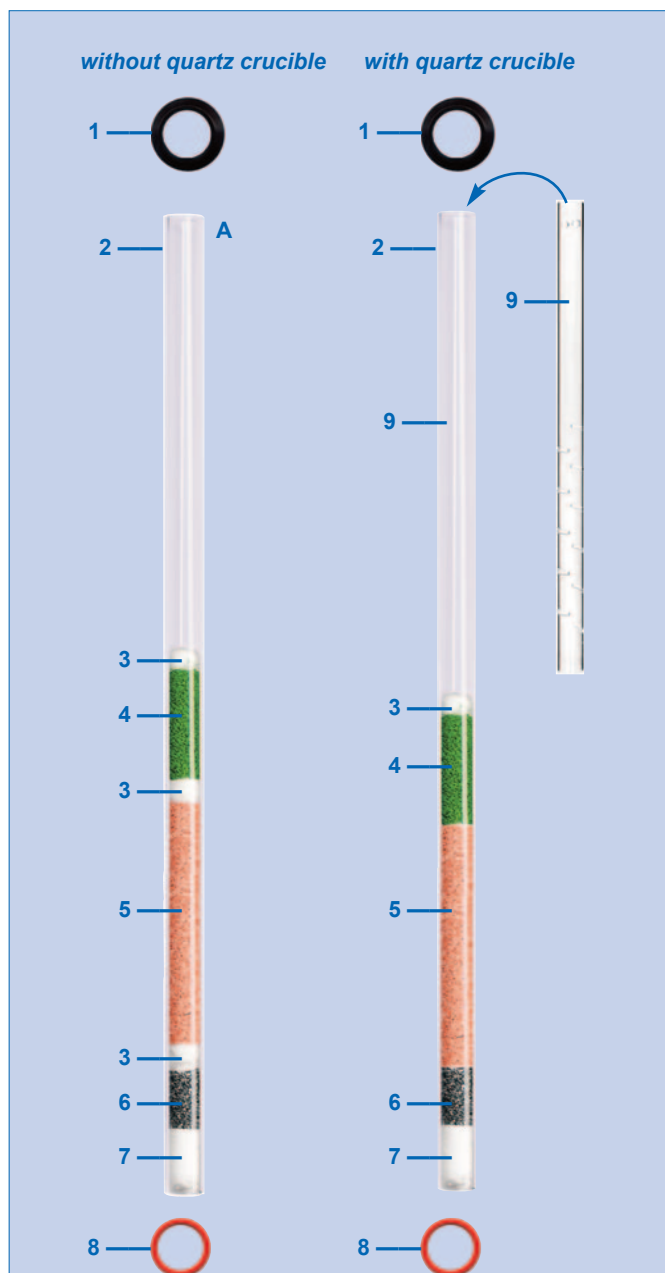

Product	Qty	OEM No.	Part No.
1 Seal chamfered square profile		29022910	E1041
2 Reaction tube		46820070	C1069
3 Quartz wool	10 mm	33822200	B1017
4 Chromium oxide granular	50 mm	33822900	B1004
5 Copper wires, coarse	110 mm	33835312	B1046
6 Cobaltous(ic) oxide silvered	30 mm	33824500	B1000
7 Quartz wool	30 mm	33822200	B1017
8 Bottom o-ring for 18 mm OD quartz reactor		29020640	E6052
9 Quartz liner		25204510	C1120
<hr/>			
A Prepacked combustion/reduction tube		46802009	X1151

Thermo Fisher Scientific® Flash series

CHNS/NCS/S determination

Thermo Fisher Scientific® Flash IRMS/ HT plus

NCS determination

Configuration guide,
CHNOS

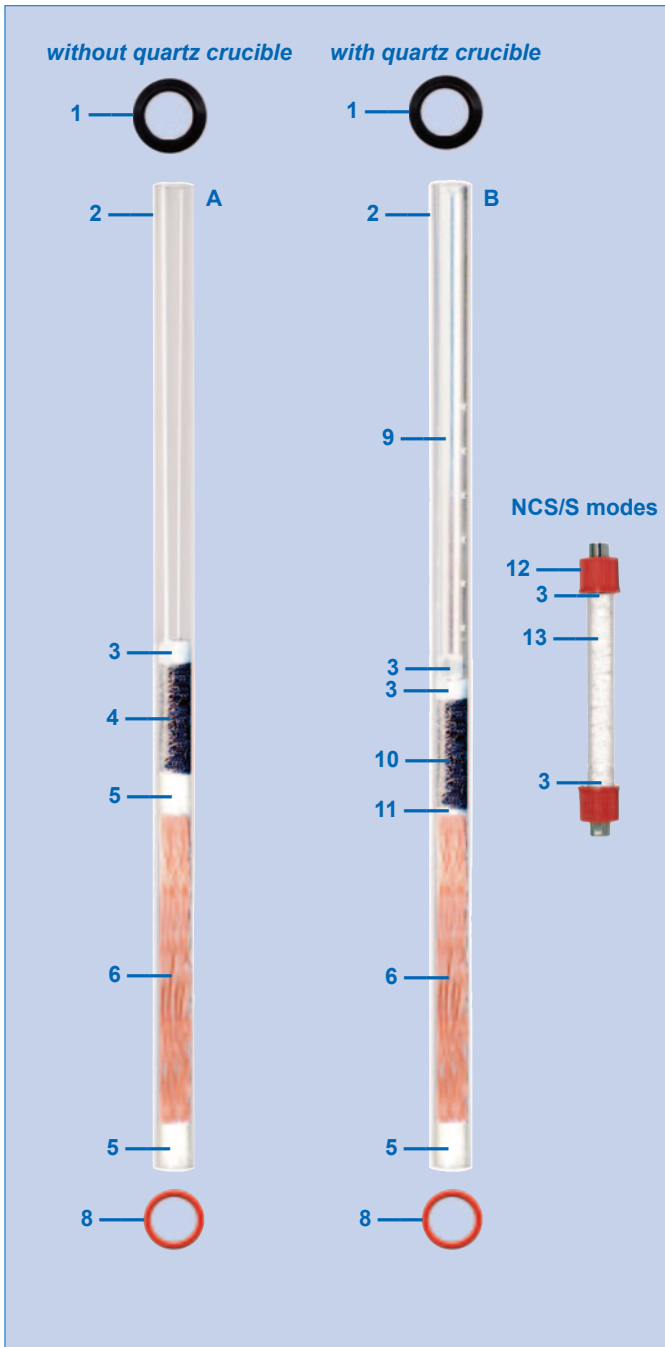

Key			
Product	Qty	OEM No.	Part No.
1 Seal chamfered square profile		29022910	E1041
2 Reaction tube		46820070	C1069
3 Quartz wool	10 mm	33822200	B1017
4 Copper oxide	50 mm	33821710	B1002
5 Quartz wool	20 mm	33822200	B1017
6 Electrolytic copper	140 mm	338 35314	B1238
8 Bottom o-ring for 18 mm OD quartz reactor		29020640	E6052
9 Quartz liner		25204510	C1120
10 Copper oxide	49.5 mm	33821710	B1002
11 Quartz wool	0.5 mm	33822200	B1017
12 Small water adsorption filter assembly		28113104	E2341
13 Magnesium perchlorate		33821900	B1274
<hr/>			
A Prepacked reactor CHNS/NCS/S		46802007	X1155
B Prepacked reactor CHNS/NCS/S inc crucible		46802015	X1160

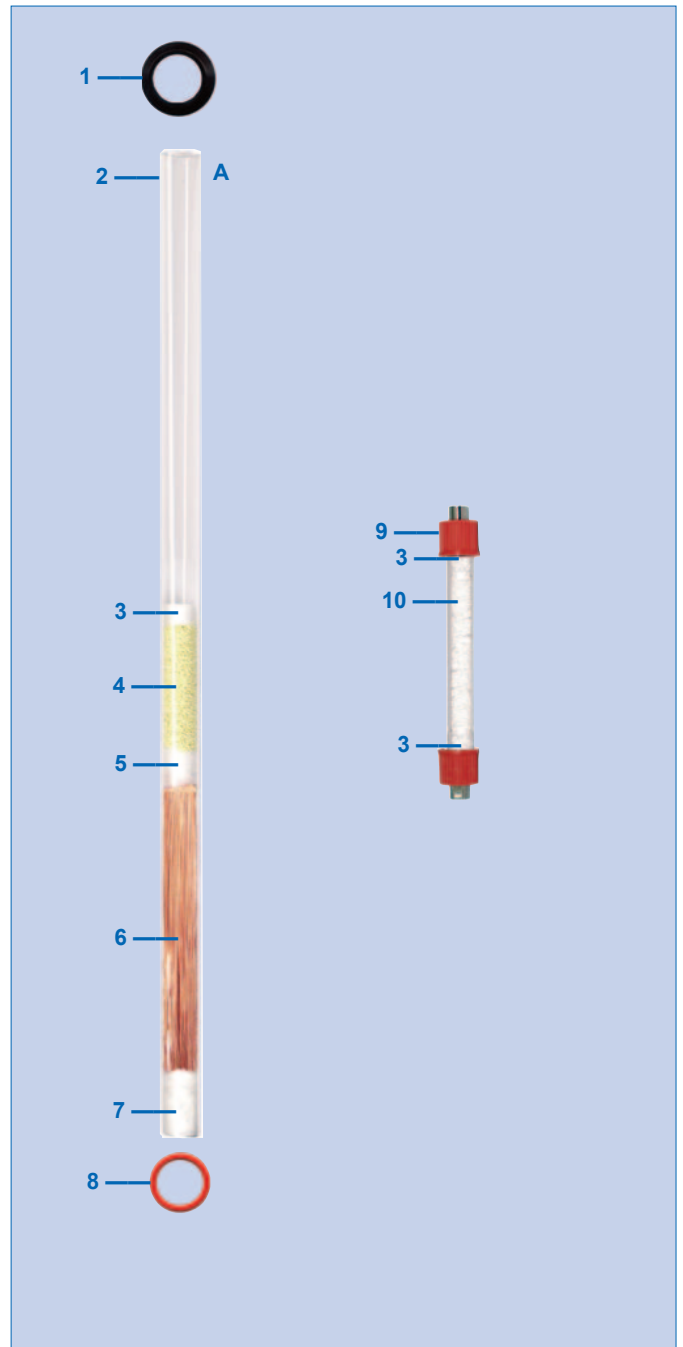

Key			
Product	Qty	OEM No.	Part No.
1 Seal chamfered square profile		29022910	E1041
2 Reaction tube		46820070	C1069
3 Quartz wool	10 mm	33822200	B1017
4 Tungsten oxide	60 mm		B1217
5 Quartz wool	20 mm	33822200	B1017
6 Electrolytic copper	(70 g) 130 mm		B1241
7 Quartz wool	30 mm	33822200	B1017
8 Bottom o-ring for 18 mm OD quartz reactor		29020640	E6052
9 Small water adsorption filter assembly		28113102	E6101
10 Magnesium perchlorate		33821900	B1274
<hr/>			
A Prepacked ox/red reactor NCS for Flash HT plus		46802021	X1172

Thermo Fisher Scientific® Flash series

N/NC determination

O determination

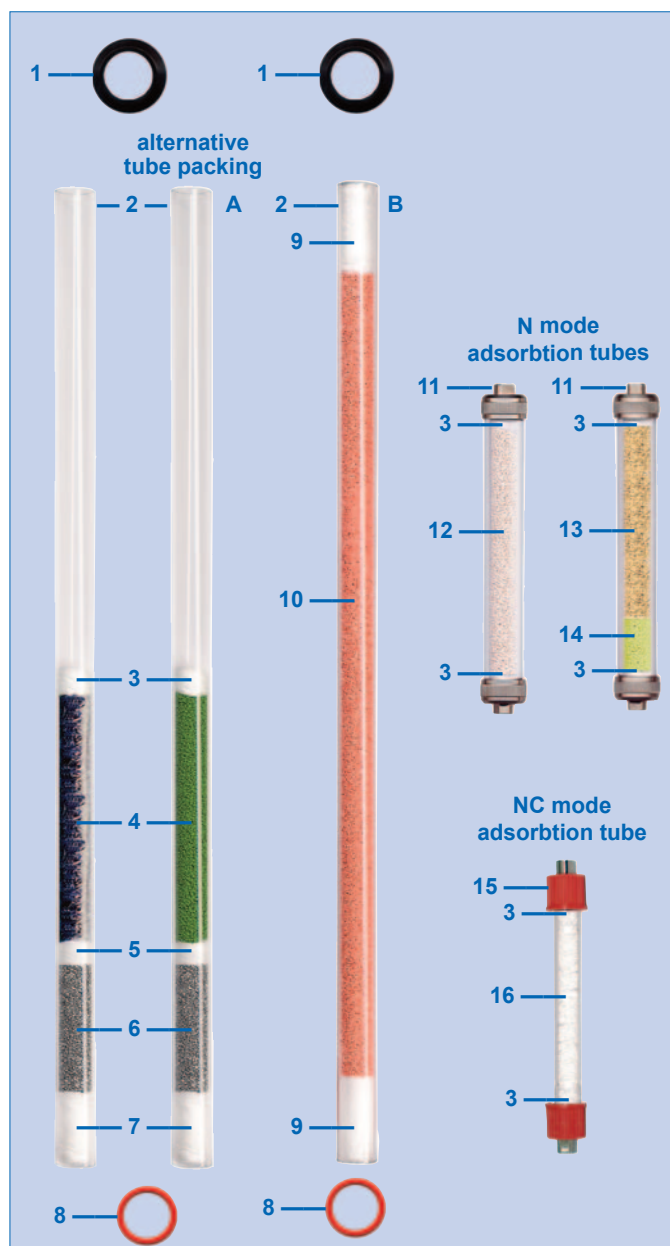

Key

Product	Qty	OEM No.	Part No.
1 Seal chamfered square profile		29022910	E1041
2 Reaction tube		46820070	C1069
3 Quartz wool	10 mm	33822200	B1017
4 Copper oxide or Chromium oxide	100 mm	33821710 33822900	B1002 B1004
5 Quartz wool	20 mm	33822200	B1017
6 Cobaltous(ic) oxide silvered	50 mm	33824500	B1000
7 Quartz wool	40 mm	33822200	B1017
8 Bottom o-ring for 18 mm OD quartz reactor		29020640	E6052
9 Quartz wool	50 mm	33822200	B1017
10 Copper wires, coarse	350 mm	33835300	B1016
11 Large adsorption trap CO ₂		28113064	F5162
12 Soda lime granular	230 mm	33835235	B1211
13 Molecular sieve 3A	180 mm	33801801	B1047
14 Silica gel self-Indicating granular	50 mm	338 40035	B1044
15 Small water adsorption filter assembly		28113104	E2341
16 Magnesium perchlorate		33821900	B1274
A Prepacked reactor N/NC		46820076	X1170
B Prepacked reduction reactor		46820077	X1171

without quartz crucible with quartz crucible

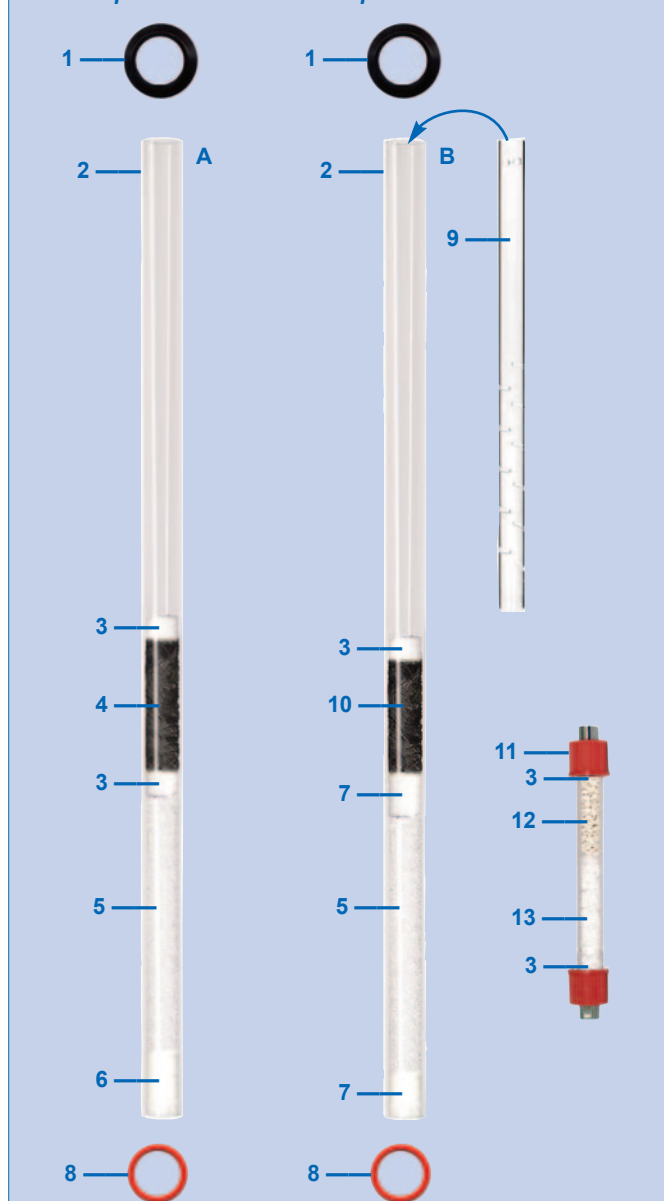

Key

Product	Qty	OEM No.	Part No.
1 Seal chamfered square profile		29022910	E1041
2 Reaction tube		46820070	C1069
3 Quartz wool	10 mm	33822200	B1017
or Nickel wool, fine wire	10 mm	33825000	B1007
4 Nickelised carbon 30% Ni granular	60 mm	33823800	B1086
5 Quartz chips	120 mm	33822300	B1008
6 Quartz wool	30 mm	33822200	B1017
7 Quartz wool	20 mm	33822200	B1017
8 Bottom o-ring for 18 mm OD quartz reactor		29020640	E6052
9 Quartz liner		25204510	C1120
10 Nickelised carbon 30% Ni granular	50 mm	33823800	B1086
11 Small water adsorption filter assembly		28113104	E2341
12 Soda lime granular		33835235	B1211
13 Magnesium perchlorate		33821900	B1274
A Packed reactor tube, oxygen		-	X1167
B Packed reactor tube, oxygen		-	X1153

NB Does not include quartz liner - please purchase item 9 separately

Legacy instruments

Elemental Microanalysis also offers product ranges to support many older legacy instruments. Products for the micro CHNOS instruments listed below are shown on the following pages:

- p 65 Exeter CE240/440
- p 66 LECO® 900/932
- p 67 Thermo Fisher Scientific® EA1108/EA1110/NA1500/NA2500

Even if your instrument is not listed here, please check the website using our OEM Search – we may have the part you need!

www.elementalmicroanalysis.com

We are also able to manufacture, or source, custom-made quartz and glassware, capsules, o-rings, and many other parts. Please email your requirements to enquiries@microanalysis.co.uk, or ask for further information.

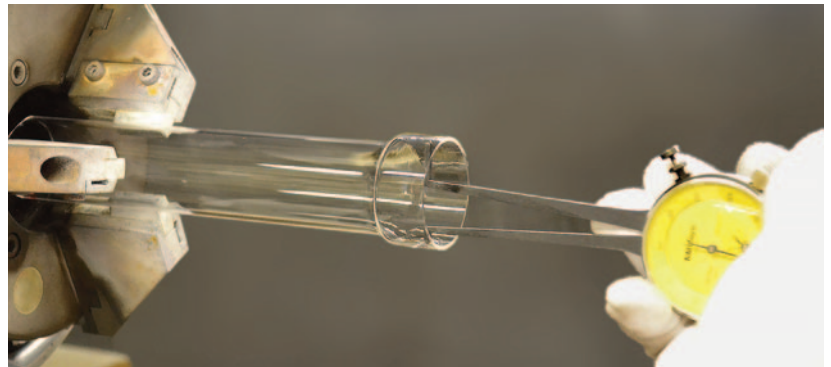

Product Sheets

Product Sheets are available for every instrument that we support. These cover all the common day-to-day items required to run your instrument. Please email your Product Sheet request to enquiries@microanalysis.co.uk.

Product Sheet – Elementar® vario MICRO cube/UNICUBE

Aluminium boats			Tin capsules for liquids		
Cat #	Description	OEM #	Cat #	Description	OEM #
D5030	Aluminium Weighing Boats 12 x 4 x 4mm pack of 100	-	D4121	Smooth Wall Tin Capsules Flat Base 11 x 4.75mm pack of 250	05 001 481
D5132	Aluminium Weighing Boats 12 x 4 x 4mm pack of 1000	03 674 012	D4120	Smooth Wall Tin Capsules Flat Base 14 x 6.75mm pack of 100	05 001 312
D5038	Aluminium Weighing Boats 12 x 4 x 4mm pack of 250	-	D4033	Smooth Wall Tin Capsules Flat Base 5.5 x 3.5mm pack of 100	05 001 727
D5133	Aluminium Weighing Boats 12 x 4 x 4mm pack of 500	03 674 010	D4001	Smooth Wall Tin Capsules Flat Base 8 x 3mm pack of 100	-
Aluminium capsules for liquids			D4131	Smooth Wall Tin Capsules Flat Base 6 x 3mm pack of 250	03 951 620
Cat #	Description	OEM #	D4035	Smooth Wall Tin Capsules Flat Base 9 x 3.5mm pack of 100	-
D4111	Aluminium Capsules Smooth Wall Flat Base 7 x 2.7mm pack of 250	05 000 814	D4132	Smooth Wall Tin Capsules Flat Base 9 x 3.5mm pack of 250	03 951 619
D4110	OBsolete PART	05 000 815	D4008	Smooth Wall Tin Capsules Round Base 20 x 8mm pack of 100	05 001 311
Silver boats			D4102	Tin Capsules Pressed Standard Weight 11 x 8mm pack of 100	05 001 400
Cat #	Description	OEM #	D1010	Tin Capsules Pressed Standard Weight 12.5 x 5mm pack of 200	-
D5127	Silver Weighing Boats 6 x 4 x 4mm pack of 500 11.03.1506	11 03-1506	D1002	Tin Capsules Pressed Standard Weight 5 x 2.5mm pack of 500	05 003 365
D5024	Silver Weighing Boats 12 x 4 x 4mm pack of 100	-	D1008	Tin Capsules Pressed Standard Weight 8 x 5mm pack of 100	-
D5039	Silver Weighing Boats 12 x 4 x 4mm pack of 1000	11 00-1371	D1008	Tin Capsules Pressed Standard Weight 8 x 5mm pack of 250	05 003 364
D5026	Silver Weighing Boats 12 x 4 x 4mm pack of 100	22 132 212	D1021	Tin Capsules Pressed Standard Weight 8 x 5mm pack of 250	-
D5034	Silver Weighing Boats 15 x 8 x 8mm 22133213 pack of 75	22 132 213	D1022	Tin Capsules Pressed Standard Weight 8 x 5mm pack of 400	-
D5035	Silver Weighing Boats 20 x 10 x 8mm 22133214 pack of 42	22 132 214	D1013	Tin Capsules Pressed Ultra Light Weight 8 x 5mm pack of 100	-
Silver capsules for liquids			D1019	Tin Containers mega box light weight 8 x 5mm set of 1000 240 06410	-
Cat #	Description	OEM #	Tin cones squares and discs		
D4102	Silver Capsules Smooth Wall 5.5 x 3.5mm pack of 250	05 000 810	Cat # <th>Description</th> <th>OEM #</th>	Description	OEM #
D4103	Silver Capsules Smooth Wall 5.5mm pack of 250	05 001 732	D2001	Tin Foil Cones Standard Weight 503-188 pack of 100	05 001 429
D4101	Silver Capsules Smooth Wall 9 x 3.5mm pack of 100	-	D0010	Tin Foil Cones Standard Weight 503-1883 Pack of 1000	05 002 797
D4109	Silver Capsules Smooth Wall 9 x 3.5mm pack of 250	05 000 817	D1116	Tin Foil Squares Standard Weight 37 x 37mm pack of	12 01-0332
Silver capsules/pans for solids					
Cat #	Description	OEM #			
D2002	Silver Capsules Pressed 5 x 3.5mm pack of 500	05 003 366			
D2103	Silver Capsules Pressed 11 x 8mm pack of 100	05 003 368			
D2008	Silver Capsules Pressed 8 x 5mm pack of 250	05 001 560			
		05 003 367			
Tin boats					
Cat #	Description	OEM #			
D5022	Tin Boats 12 x 4 x 4mm pack of 100	-			

We can also provide parts for other legacy instruments, including those micro CHNOS instruments listed below. Check the website for our range of products for these instruments, or contact enquiries@microanalysis.co.uk for a product sheet.

Elementar® CHN rapid
Elementar® vario EL
PerkinElmer® 240ABC
Thermo Fisher Scientific® EA1106

Exeter CE240/440

Furnace tubes

Part No	Description	Pack	OEM part
C6000	Combustion tube, CHN CEC240/440	1	0240-1255
C6001	Combustion tube, CHN CEC240/440	1	6703-0514
C6002	Combustion tube, CHN CEC240/440	1	6703-0585
C6003	Combustion tube, CHN CEC240/440	1	6703-0378
C6006	Combustion tube, sulfur CEC240/440	1	0240-1369
C6007	Combustion tube, sulfur CEC240/440	1	6703-0581
C6008	Combustion tube, sulfur CEC240/440	1	6703-0580
C6017	Pyrolysis tube, oxygen CEC240/440	1	0240-1962
C6018	Pyrolysis tube, oxygen CEC240/440	1	6703-0565
C6019	Pyrolysis tube, oxygen CEC240/440	1	6703-0406
C2002	Reduction tube, CHN 240BC/CEC240/440	1	0240-1573
C2011	Reactor tube, oxygen 240ABC/CEC240/440	1	0240-1963
C2012	Reduction tube, sulfur 240ABC/CEC240/440	1	0240-1961

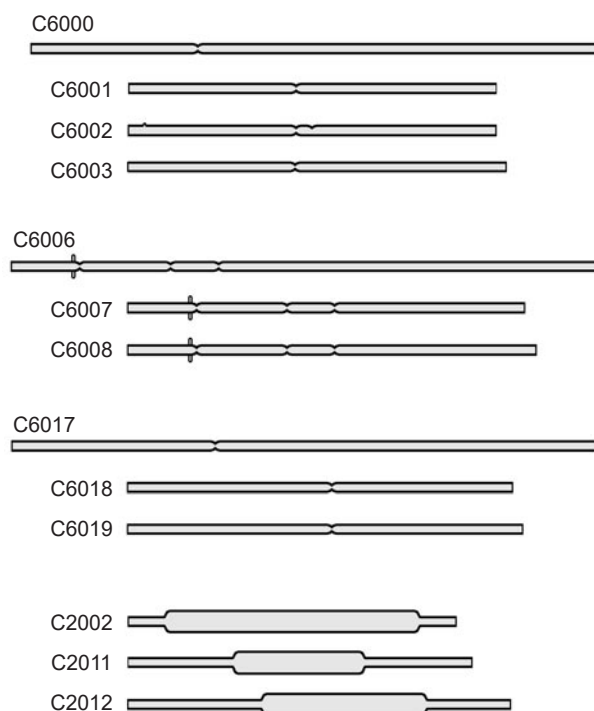

Legacy Instruments

Scrubber tubes, traps, connectors

Part No	Description	Pack	OEM part
C6011	Connector tube, drive box CEC240/440	1	318-00009
C6026	Scrubber tube, large diameter CEC240/440	1	0240-1217B
C6009	Scrubber tube, sulfur CEC240/440	1	0240-1372
C2004	Scrubber tube, 240ABC/CEC240/440	4	0240-1217
C2008	U-tube, oxygen 240ABC/CEC240/440	1	0240-1356
C6010	U-tube, sulfur CEC240/440	1	0240-1371

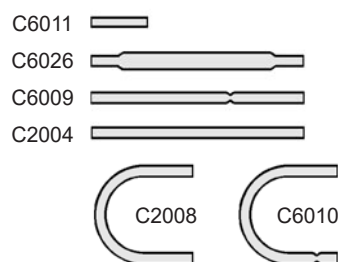

Ladles

Part No	Description	Pack	OEM part
C6022	Ladle straight CEC240/440	1	6703-0503
C6023	Ladle anti-jetting CEC240/440	1	6703-0584
C6024	Ladle curved CEC240/440	1	6703-0376
C6025	Ladle small diameter CEC240/440	1	6703-0589
C6021	Magnetic ladle for refractories CEC240/440	1	0240-2061A
C2003	Magnetic ladle 240ABC/CEC240/440	1	0240-1321B
C6020	Magnetic ladle with cutout CEC240/440	1	0240-1321A

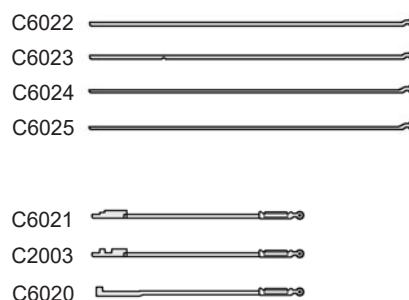

O-rings & seals

Part No	Description	Pack	OEM part
E1005	O-ring nitrile rubber	10	0990-2017
E1006	O-ring nitrile rubber	10	0240-1582
E1007	O-ring	10	0240-1581
E1013	O-ring	10	0240-1583
E1015	O-ring nitrile rubber	2	0240-1293
E1032	O-ring nitrile rubber		316-00003
E1033	O-ring nitrile rubber		316-00008

Other operating supplies

Part No	Description	Pack	OEM part
E2011	Filter discs glass	12	0240-0137A
D7006	Platinum gauze 225 mesh 12 x 150 mm		0240-1147B
E2212	Sample holder		
D6003	Sleeve ceramic, 7 x 40 mm	10	0240-0810A

LECO® 900/932

Quartz, glassware, crucibles & furnace tubes



Legacy Instruments

Part No	Description	Pack	OEM part
C4006	Catalyst heater tube, silica	1	776-279
C4002	Combustion tube, silica	1	605-875
C4003	Combustion tube, bulk pack C4002	5	605-875
C4007	Crucible, silica	5	
C4004	Reagent tube, borosilicate	1	775-601
C4005	Reagent/filter tube, borosilicate	1	775-880
C4027	Filling funnel, borosilicate	1	502-023
C4032	Bubble/filter/reagent tube, borosilicate	1	771-030
C4033	Oxygen lance, silica	1	604-541
C4034	Crucible, ceramic	10	501-045(-125)
C4337	Reagent tube 6"	1	774-638
C7000	Inner pyrolysis tube	1	608-130

Prepacked tubes

Part No	Description	Pack
X3001	Prepacked reduction tube	1
X3002	Prepacked tube CHN with halogens	1
X3003	Prepacked tube CHN	1
X3004	Prepacked reaction tube CHNS	1
X3005	Prepacked incoming reduction tube	1
X3006	Prepacked scrubber/reagent tube	1

These products are classified as hazardous for shipping

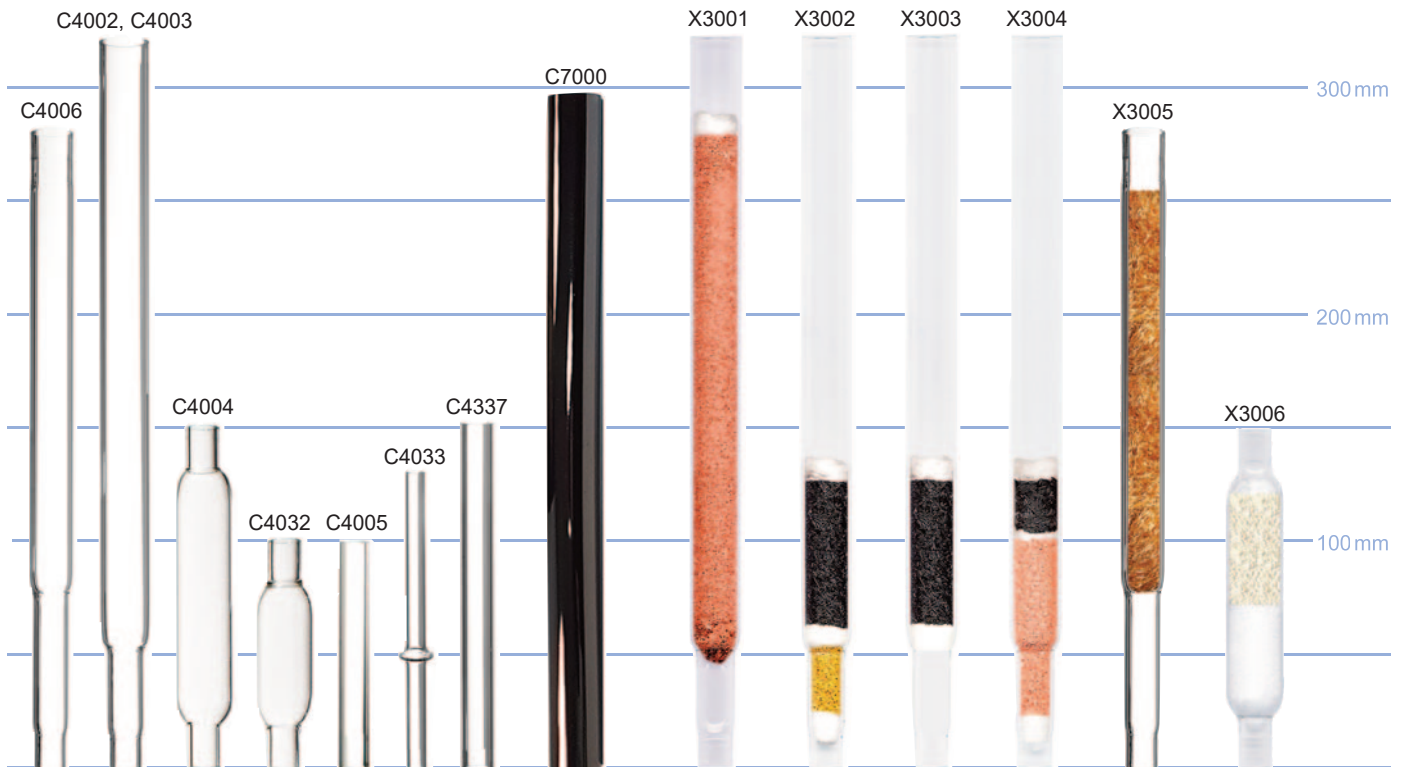

O-rings

Part No	Description	Pack	OEM part
E1100	O-ring sample drop block 18.7 x 2.6 mm	1	772-910
E1105	O-ring comb./catalyst/filter tube, 6.0 x 2.6 mm	1	605-828
E1110	O-ring, block assembly, 6.0 x 2.6 mm	1	772-520
E1111	O-ring catalyst heater assembly, 6.1 x 1.8 mm	1	772-738
E1112	O-ring sample drop block, 21.9 x 2.6 mm	1	589-551
E1126	O-ring catalyst/reaction tube	1	605-830
E1127	O-ring lance tube	1	760-224
E1129	O-ring sample drop block	1	774-283
E1130	O-ring sample drop block piston	1	774-613
E1131	O-ring catalyst heater tube, 10.8 x 2.6 mm	1	778-114
E1132	Seal	1	589-305
E1133	O-ring filter tube, 15.5 x 3.5 mm	1	765-976

Operational accessories

Part No	Description	Pack	OEM part
E2230	Sample drop plate SS		606-121
E2201	Screws, lance assembly	4	190-423
E2238	Seal, piston	1	601-883
E2235	Secondary (screen) filter		775-306

Secondary (screen) filter E2235



The use of LECO® part numbers is intended for convenience only, and does not imply that the products are of OEM origin. All Elemental Microanalysis products are guaranteed to be of high quality and are deemed to be suitable alternatives in the stated instruments. All LECO® trademarks acknowledged.

Thermo Fisher Scientific® EA1108/EA1110/NA1500/NA2500

Furnace tubes, liners & inserts

Part No	Description	Pack	OEM part	Part No	Description	Pack	OEM part
C1072	Reaction tube heavy wall, Quick 'n' Easy system	1		C1136	Quartz insert open both ends 15 x 205 mm	5	
C1066	Reaction tube, Quick 'n' Easy system	1		C1120	Quartz liner	1	25204510
C1078	Reaction tube heavy wall 46820001	1	46820060	C1127	Quartz liner	5	25204510
C1057	Reaction tube modified low volume	1		C2032	Sleeve insert CHNS EA1108	1	
C1056	Reaction tube modified	1		C1091	Sleeve insert closed end	1	
C1024	Reaction tube modified	1		C1096	Sleeve insert open both ends 13 x 220 mm	1	
C1060	Reaction tube modified, for E2171 fitting	1		C1093	Sleeve insert open both ends 235 mm	1	
C1002	Reaction tube	1	46801600	C1135	Sleeve insert open end 13 x 205 mm	5	
C1018	Reaction tube	1	46820020	C1090	Sleeve insert open end 205 mm	1	
C1022	Reaction tube	1	46820060	C1052	Sleeve insert 1108/1110	1	
E2140	Reaction tube stainless steel			C1051	Sleeve insert 13 mm OD 235 mm	1	
E2159	Reaction tube stainless steel		46820050	C2030	Sleeve insert NA1500(1)	1	

Legacy Instruments

Reaction tube, stainless steel, E2159

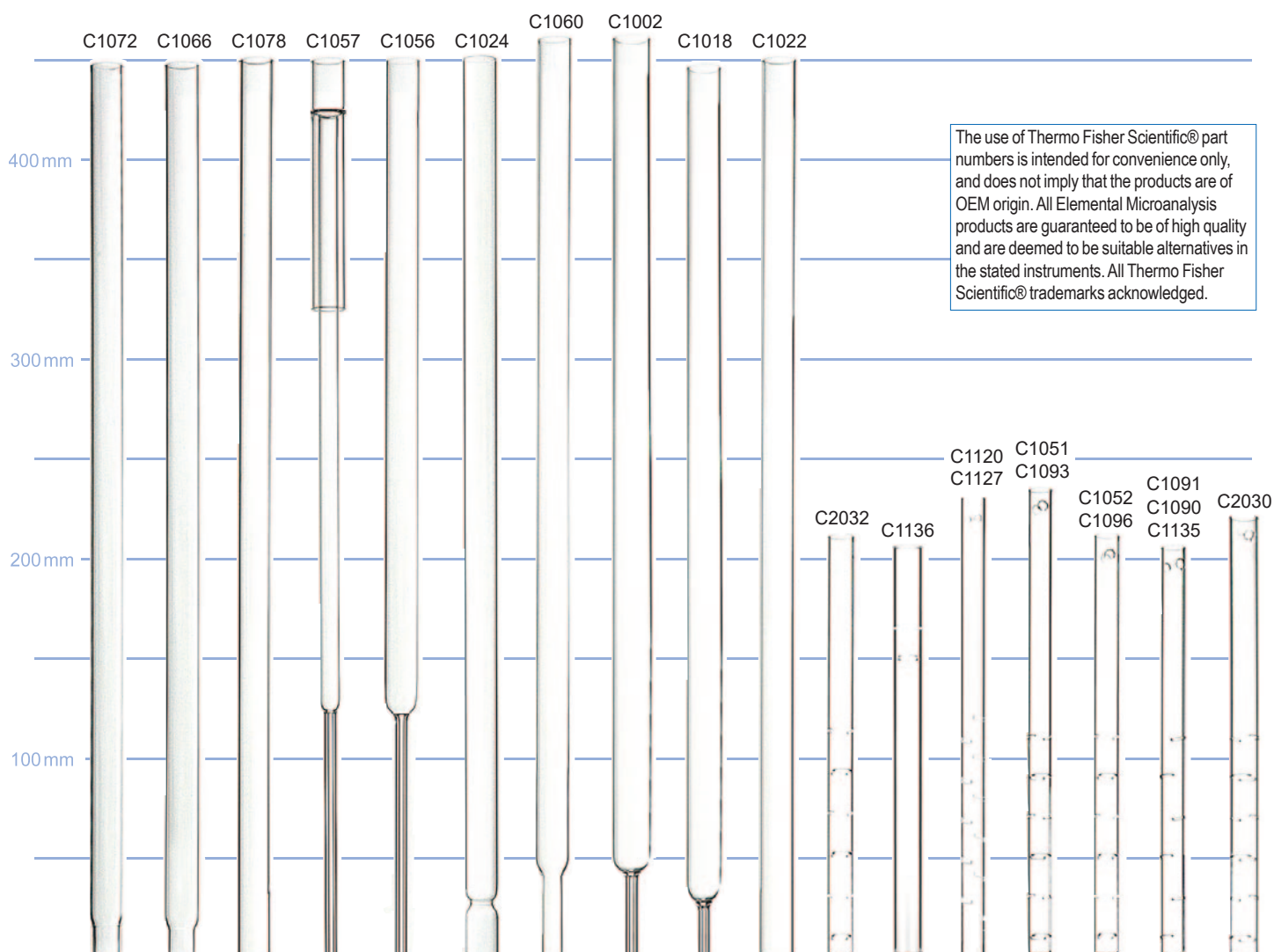

Thermo Fisher Scientific® EA1108/EA1110/NA1500/NA2500

Legacy Instruments

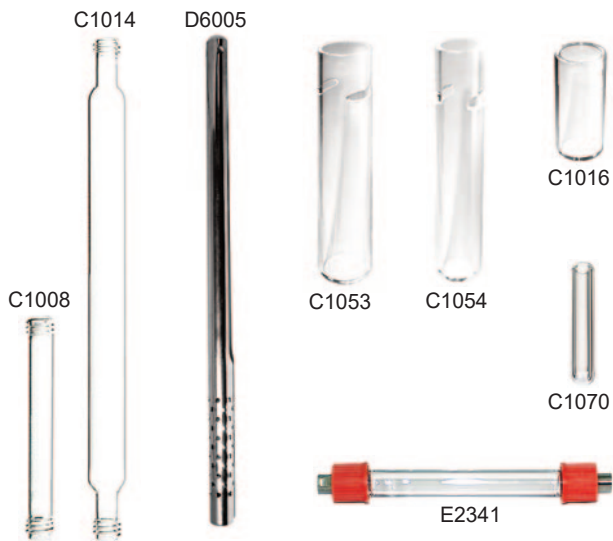

Crucibles & other quartz/glassware

Part No	Description	Pack	OEM part
C1042	Chloropentane doping vessel, borosilicate	1	24000700
C1053	Removable swarf crucible 60 x 14 mm	5	
C1054	Removable swarf crucible 60 x 13 mm	5	
C1014	Scrubber tube, CO ₂ , threaded, borosilicate	1	28113090
C1008	Scrubber tube, H ₂ O, threaded, borosilicate	1	23103008
E2341	Small water adsorption filter assembly (caps, o-rings & SS fitting)	1	28113104
C1006	Swarf crucible 30 x 14 mm for C1022/C1024	5	
C1016	Swarf crucible 30 x 13 mm for C1069/C1072/C1078	5	25204600
C1007	Swarf crucible 35 x 16 mm NA1500 Series 1	5	
C1070	Spare doping vessel for E2220	5	
D6005	Metal swarf crucible	1	25205000

O-rings & seals

Part No	Description	Pack	OEM part
E1000	O-ring	10	29050567
E1003	O-ring nitrile rubber	10	
E1004	O-ring nitrile rubber	10	29030042
E1011	Bi-pneumatic valve diaphragm		31302100
E1020	O-ring nitrile rubber	10	29050304
E1021	O-ring Schott type silicone/PTFE	10	29013603
E1022	O-ring nitrile rubber	10	29050301
E1023	O-ring Schott type silicone/PTFE	2	29013603
E1041	Seal chamfered square profile	5	29022910
E1042	Seal chamfered square profile	5	29030042
E1045	Seals nitrile rubber flat profile	2	
E1135	O-ring reagent tube 11 mm	1	
E1136	O-ring reagent tube 22 mm	1	

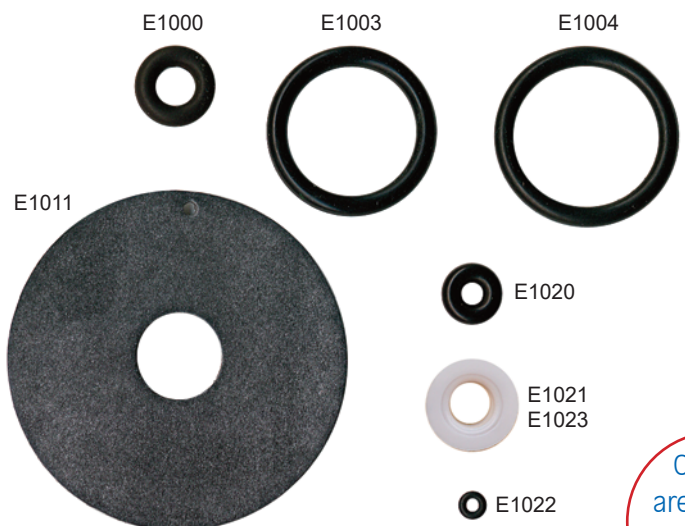

Operational accessories

Part No	Description	Pack	OEM part
E2173	Cap small for E2171	1	
E2174	Cap large PTFE for E2171	1	
F2201	Cone replacement kit AS128	1	19004157
F2401	Cooling fan 120 mm 240VAC 18W	1	40600300
E2220	Doping vessel kit chloropentane	1	
E2172	Ferrule PTFE 2 mm for E2171	4	
E2138	Furnace core w/o thermocouple	1	354 50010
E2134	Ratchet cam spring carousel stainless steel	1	
E2135	Ratchet spring carousel stainless steel	1	
E2171	Reaction tube fitting kit PTFE 11 to 2 mm, for C1060 tube	1	
E2175	Seal large for E2171	4	
E2350	Scrubbing tube kit water	1	28113100
E3025	Separation column NC semi-macro 2m PTFE	1	
F4541	Sleeve PTFE OD 2 mm	10	290 34545
F2223	Slider autosampler AS50LS	1	37001101
F2176	Solenoid valve 4W	1	40519015
E2067	Thermal chart paper roll	1	24806400
F2153	Thermocouple	1	40320000
F4510	Tube coupling 18 to 2 mm lower reaction	1	34709518
F6112	Upper seal AS128 PTFE	1	29003195



Thermo Fisher Scientific® EA1108/EA1110/NA1500/NA2500

Consumables kits

Part No	Description	OEM part
X1003	Consumables kit, 1000 analyses, 1108/II CHN	19001203
X1004	Consumables kit, 1000 analyses, 1108/II CHN & oxygen	19001201
X1005	Consumables kit, 1000 analyses, 1108/II CHNS	19001204
X1006	Consumables kit, 1000 analyses, 1108/II CHNS & oxygen	19001202
X1007	Consumables kit, 1000 analyses, 1108/II oxygen	19001301
X1025	Consumables kit, 1000 analyses, 1108/I CHN	
X1026	Consumables kit, 1000 analyses, 1108/I CHN & oxygen	
X1027	Consumables kit, 1000 analyses, 1108/I CHNS	
X1028	Consumables kit, 1000 analyses, 1108/I CHNS & oxygen	
X1029	Consumables kit, 1000 analyses, 1108/I oxygen	
X1008	Consumables kit, 1000 analyses, 1500/II nitrogen	
X1009	Consumables kit, 1000 analyses, 1500/II NC	
X1010	Consumables kit, 1000 analyses, 1500/II NCS	
X1022	Consumables kit, 1000 analyses, 1500/I nitrogen	
X1023	Consumables kit, 1000 analyses, 1500/I NC	
X1024	Consumables kit, 1000 analyses, 1500/I NCS	

 These products are classified as hazardous for shipping

Visit our website, elementalmicroanalysis.com to view the contents lists of our consumables kits.

Prepacked tubes

Part No	Description	OEM part
X1031	Prepacked reaction tube, EA1108 NA1500, NCH NNC, stainless steel	
X1032	Prepacked reduction tube, NA1500 II NA2000 stainless steel	
X1034	Packed reaction/reduction tube, EA1108 EA1110, CHN single tube system	46802006
X1036	Prepacked reactor tube, 1108/1500(2) for use with E2193, Quick Fit system	
X1037	Prepacked reduction tube using coarse copper wires (B1016)	46800650
X1039	Prepacked reactor tube, N/NC/CHN 1108/1500 for use with E2193, Quick Fit system	
X1040	Prepacked reduction tube, EA1108, CHN	
X1041	Prepacked reaction tube, EA1108 NA1500, NCH N NC	
X1044	Prepacked CHN reaction tube, 1108, single tube system (C1024 tube)	
X1045	Prepacked reactor tube, 1108/1500(2) 2 mm wall	
X1046	Prepacked reactor tube, 1108/1500(2)	
X1047	Prepacked reactor tube, 1108, oxygen	
X1048	Prepacked reduction tube, 1500(2)/2500	46800650
X1060	Prepacked reactor tube, CHNS/NCS/S, EA1110	
X1062	Prepacked reaction tube, EA1500(2), CHN N NC	
X1064	Prepacked reaction tube, N/NC, NA1500(1)	
X1066	Prepacked reduction tube, N/NC, NA1500(1)	
X1068	Prepacked reactor tube, NCS, NA2500	
X1070	Prepacked reaction tube, EA1108 NA2500, CHN N NC 2 mm wall	
X1165	Prepacked reaction tube, 1500/1110/1108/2500 (electrolytic wires) CHNS	46802005

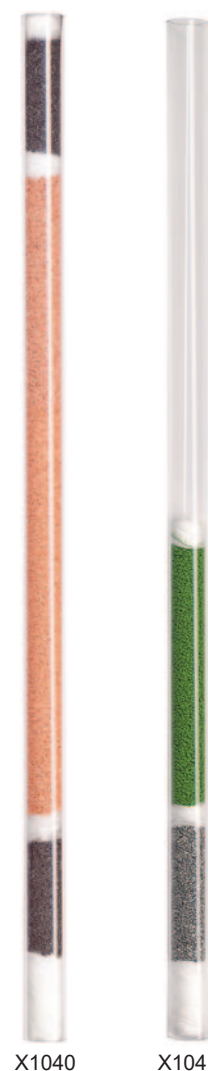

X1040

X1041

Additional products for CF-IRMS

The following section contains additional products that are mainly used for CF-IRMS and HT pyrolysis work. Products that are used for both micro CHNOS analysis and CF-IRMS are listed in the main section of this catalogue.

This section includes CF-IRMS products for the following instruments:

Elementar® vario PYRO cube

EuroVector EA-3028HT

HEKAtech HT-O

Thermo Fisher Scientific® TC/EA & Flash series instruments

Sercon isoEarth, isoEarth+, EEarth, and Integra2

Legacy instruments - Sercon (Europa) GSL/Integra, and Orchid

Reagents CF-IRMS analysis

This section contains reagents that are specifically used only in CF-IRMS. Reagents that are used in both CHNOS and IRMS analysis are listed in the main section of this catalogue, pp 21–25.

For our range of isotope reference materials, see p 78.

Part No	Description	Pack
B1158	1% platinum/ 1% nickel oxide on copper oxide granules, isotope catalyst 0.2 to 0.5 mm	5 g
B1149	1% platinum/ 1% nickel oxide on copper oxide wires, isotope catalyst	5 g
B1159	3% platinum/ 1% nickel oxide on copper oxide granules, isotope catalyst 0.2 to 0.5 mm	5 g
B1151	3% platinum/ 1% nickel oxide on copper oxide wires, isotope catalyst	5 g
B1451	Chrome catalyst	25 g
B1450	Chrome catalyst	100 g
B1051	Copper oxide granular, isotope grade 0.1 to 0.5 mm	50 g
B1071	Copper oxide granules, silvered, isotope grade 0.1 to 0.5 mm	50 g
B1080	Copper oxide wires, isotope grade 4 x 0.5 mm	50 g
B1070	Copper oxide wires, silvered, isotope grade 4 x 0.5 mm	50 g
C7003	Glassy carbon chips 2-3 mm	25 g
C7008	Glassy carbon chips 2-3 mm	50 g
C7006	Glassy carbon chips 2-3 mm	100 g
C7002	Glassy carbon chips 3-4 mm	25 g
C7015	Glassy carbon chips 3-4 mm	50 g
C7021	Glassy carbon chips 3-4 mm	80 g
B1065	High purity carbon granular, 0.2 to 0.5 mm	1 g
B1130	Nickel oxide granular, 0.2 to 0.5 mm	25 g
B1182	Nickelised carbon, 50% Ni granular 0.85 to 1.7 mm	5 g
B1096	Platinised alumina 10% Pt, granular, isotope grade 0.2 to 0.5 mm	2 g
B1097	Platinised alumina 20% Pt, granular, isotope grade 0.2 to 0.5 mm	2 g
B1030	Platinised copper oxide, 10% Pt, granular, isotope grade 0.2 to 0.5 mm	2 g
B1050	Platinised copper oxide, 20% Pt, granular, isotope grade 0.2 to 0.5 mm	2 g
D9101	Copper wire 0.125 mm diameter x 10 m	10 m
B1156	Copper wire 0.1 mm high purity sealed ampoule 12 x 300 mm	300 mm
D9102	Nickel wire 0.125 mm diameter x 10 m	10 m
D9100	Platinum wire 0.125 x 1 m	1 m

Glassy carbon chips 3-4 mm, 25 g
C7002



Nickelised carbon 50% Ni granular 0.3 to 0.85 mm, 5 g
B1181

Isotope catalyst 0.2 to 0.5 mm, 5 g
B1158



Chrome catalyst 100 g
B1450



Need to find a product using the manufacturer part number?

– Our cross reference lists can help with that, see p 86.

Elementar®/GVI	Part No	Description	OEM part
	C1106	Ceramic tube, PYRO cube	23.00-1021
	C7017	Glassy carbon tube, PYRO cube	23.00-1020
	C1113	Furnace reaction tube, ceramic, 1.5 x 0.5 x 320 mm	

HEKAtech	Part No	Description	OEM part
	C1103	Ceramic tube, HT-O	468110
	C7004	Glassy carbon tube	46860100

Sercon (Europa)	Part No	Description	OEM part
	C1077	Ceramic tube 1.55 mm x 0.6 mm x 300 mm, Sercon Orchid	
	C1103	Ceramic tube, HT-EA Wave	SC0694
	C1112	Furnace reaction tube, ceramic, Sercon Orchid	
	C7001	Glassy carbon tube	SC0971
	X7022	Ceramic tube with molybdenum foil liner for HT-EA	SC2332

EuroVector	Part No	Description	OEM part
	C1102	Ceramic tube, EuroVector, 2-pack	E12507
	C7004	Glassy carbon tube, EuroVector	E12529

Key

Products are colour coded according to the IRMS technique they are used in, as follows:

- High temperature
- O/H pyrolysis or reduction
- CN-IRMS, S-IRMS, CNS-IRMS
- GC combustion/pyrolysis

The use of OEM part numbers is intended for convenience only, and does not imply that the products are of OEM origin. All Elemental Microanalysis products are guaranteed to be of high quality and are deemed to be suitable alternatives in the stated instruments. All trademarks acknowledged.

Thermo Fisher Scientific®	Part No	Description	OEM part
	C1101	Ceramic tube for TC/EA	1121320
	C1105	Flash 2000 HT ceramic outer tube	1156890
	C1111	Furnace reaction tube, ceramic	
	C7001	Glassy carbon tube, TC/EA	1121310
	C7005	Glassy carbon tube closed one end with 2 mm hole, TC/EA	
	C7007	Glassy carbon tube for use with E4405, 12 x 9 x 453 mm	
	C7009	Glassy carbon tube closed one end with 2 mm hole for use with E4405, 12 x 9 x 420 mm	

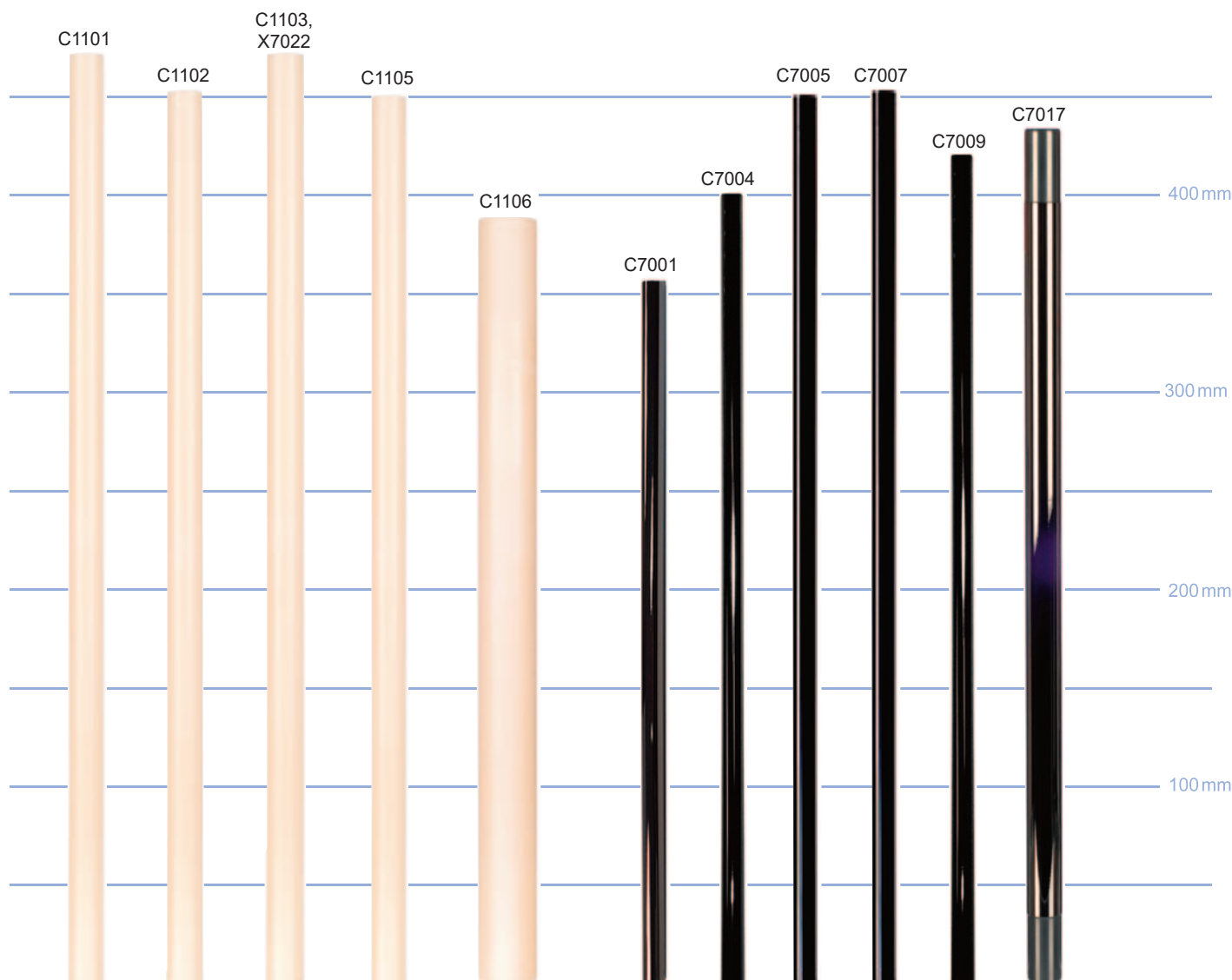

CF-IRMS products

Quartz/glass furnace & scrubbing tubes CF-IRMS analysis

Part No	Description	OEM part
C1056	Reaction tube, modified, transp. silica	E12512

Part No	Description	OEM part
C1115	Furnace reaction tube, quartz, 630 mm x 6 mm OD, 0.7 mm ID	
C1116	Furnace reaction tube, quartz, 610 mm x 6 mm OD, 0.5 mm ID	
C3051	Combustion tube, Pyrocube	23.00-1150
C3050	Reduction tube, Pyrocube	23.00-1149

Part No	Description	OEM part
C1200	Reaction tube	C0201

Part No	Description	OEM part
C1039	Reaction tube, heavy wall silica	SC0012
C1040	Reaction tube, transp. silica	SC0650
C1038	Reduction tube, 6 mm OD, 4 mm ID, 370 mm	
C1063	Scrubbing tube borosilicate	SC0040
C1008	Scrubbing tube	SC0084
C1076	Oxidation tube, Orchid	SC0675

Part No	Description	OEM part
C1104	Thermo precon scrubber	1068230
E6101	Small trap with o-rings, threaded caps, and fitting (takes 2 mm tubing nuts)	28113102

Key

Products are colour coded according to the IRMS technique they are used in, as follows:

- High temperature
- O/H pyrolysis or reduction
- CN-IRMS, S-IRMS, CNS-IRMS
- GC combustion/pyrolysis

The use of OEM part numbers is intended for convenience only, and does not imply that the products are of OEM origin. All Elemental Microanalysis products are guaranteed to be of high quality and are deemed to be suitable alternatives in the stated instruments. All trademarks acknowledged.

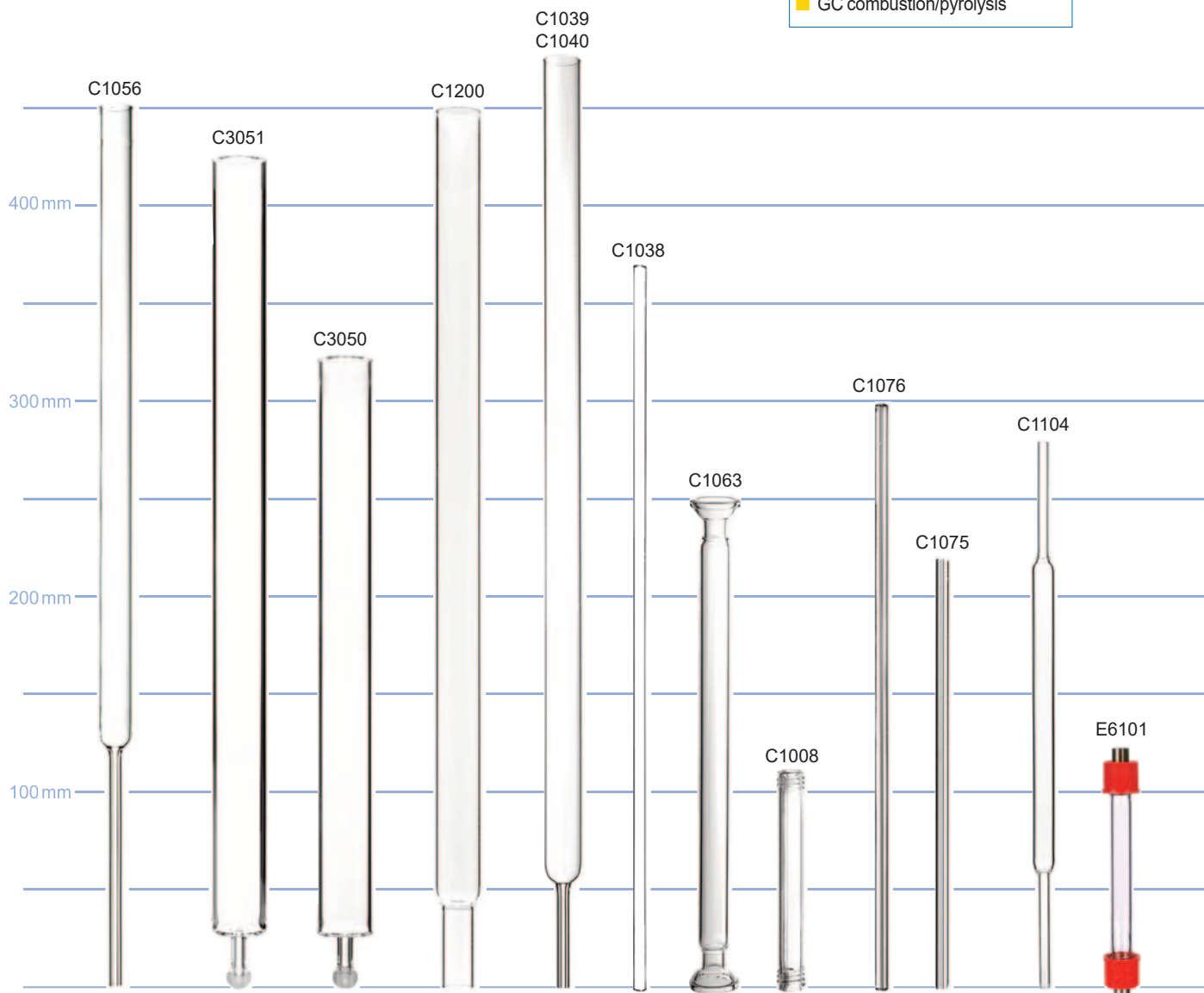

Key

Products are colour coded according to the IRMS technique they are used in, as follows:

- High temperature
- O/H pyrolysis or reduction
- CN-IRMS, S-IRMS, CNS-IRMS
- GC combustion/pyrolysis

Part No	Description	OEM part
C7012 ■	Graphite crucible for TC/EA	1117332
C7013 ■	Large graphite crucible for TC/EA 5 to 5.1 mm wide	SC2388
C7014 ■	Extra large graphite crucible for 9 mm id glassy carbon tubes 5.9 mm wide	SC2389
C7019 ■	Hexagonal graphite crucible for TC/EA for use in 7 mm ID glassy carbon tubes	
C7020 ■	Octagonal graphite crucible for TC/EA for use in 9 mm ID glassy carbon tubes	

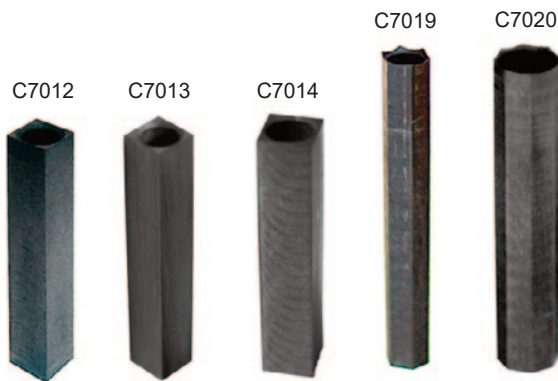

CF-IRMS products

Part No	Description	OEM part
C1050 ■	Sleeve insert, open both ends transparent silica 15 x 180 mm	SC0011
C1094 ■	Sleeve insert, open both ends transparent silica 15 x 220 mm	SC0687
C2030 ■	Sleeve insert, transparent silica NA1500(1)	SC0729
C3028 ■	Oxygen lance 90 mm	05 002 321
C3029 ■	Support tube 175 mm vario PYRO cube	
C3052 ■	Support rod vario PYRO cube 175 mm	23.00-1148
C3053 ■	Support rod reduction tube 65 mm	11.00-1364/4
C3061 ■	Ash crucible graphite	23.00-1189
C3072 ■	Support tube 12 mm OD x 60 mm	15.00-1119
C7018 ■	Ash finger - high temperature vario PYRO cube	15.00-1189
C7010 ■	TC/EA graphite tube	1121351
C7011 ■	H ₂ O graphite tube for TC/EA	1132080
C7022 ■	Cone for glassy carbon reactor (1pcs) EuroVector	C10-181



The use of OEM part numbers is intended for convenience only, and does not imply that the products are of OEM origin. All Elemental Microanalysis products are guaranteed to be of high quality and are deemed to be suitable alternatives in the stated instruments. All trademarks acknowledged.

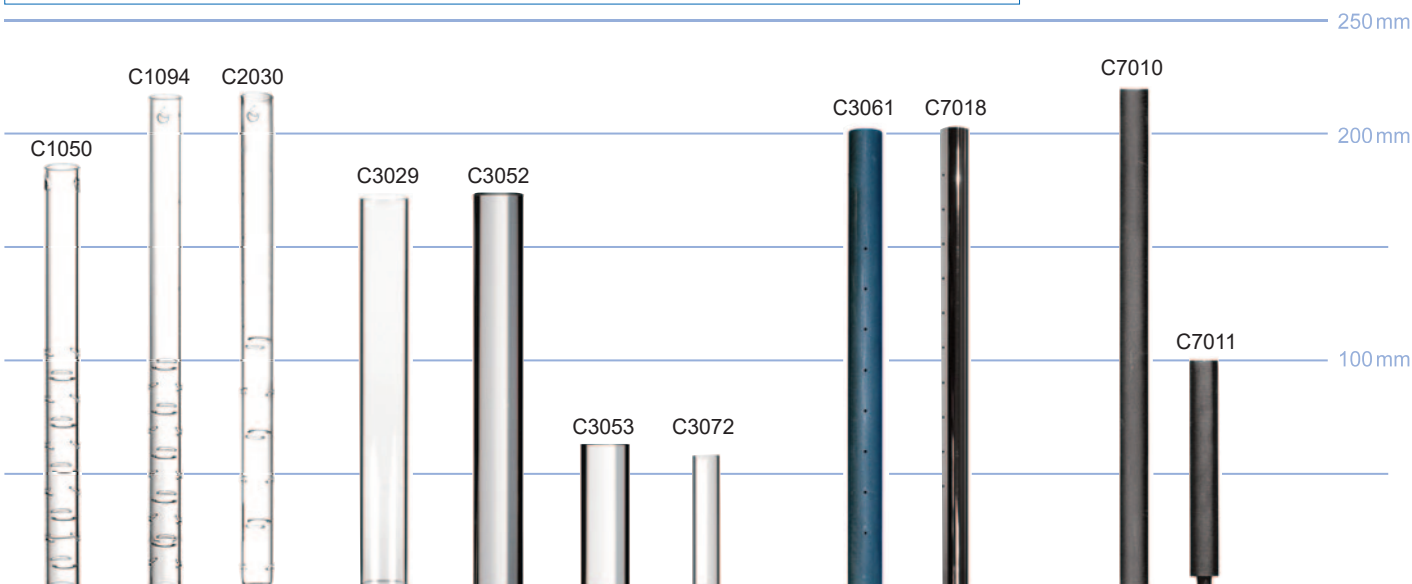

Prepacked tubes CF-IRMS analysis

	Part No	Description	OEM part
Elementar®	X1504	Prepacked GC reaction tube 630 x 1/4 x 0.7 mm quartz copper oxide wires + 1%Pt + 1%NiO	
Sercon (Europa)	X1200	Prepacked reaction tube, transparent, includes C1050 quartz liner	SC2147
	X1201	Prepacked reaction tube, transparent heavy wall, includes C1050 quartz liner	SC2149
	X1203	Prepacked reduction tube	SC2151
	X1204	Prepacked reduction tube, transparent heavy wall	SC2152
	X1205	Prepacked reaction/reduction tube sulfur, transparent	SC2153
	X1207	Prepacked oxygen pyrolysis tube, transparent silica	SC2155
	X1209	Packed hydrogen pyrolysis tube, transparent silica	SC2157
	X1212	Prepacked combustion tube (with liner) for isoEArth+	
	X1213	Prepacked equilibration tube for isoEArth+	
	X1501	Prepacked GC reaction tube 400 x 1.6 x 0.8 mm ceramic, copper wire	SC2177
	X1505	Prepacked GC oxidation reactor tube 320 x 1.5 x 0.5 mm ceramic, copper/platinum/nickel wire	
	X1506	Prepacked GC reduction reactor tube 320 x 1.5 x 0.5 mm ceramic, copper wire	
	X1507	Prepacked GC reaction tube 400 x 1.6 x 0.8 mm ceramic, copper/nickel/platinum wires	
Thermo Fisher Scientific®	X1104	Prepacked Thermo precon scrubber	
	X1505	Prepacked GC oxidation reactor tube 320 x 1.5 x 0.5 mm ceramic, copper/platinum/nickel wire	1040920
	X1507	Prepacked GC reaction tube 400 x 1.6 x 0.8 mm ceramic, copper/nickel/platinum wires	
	X1500	Prepacked GC reaction tube 600 x 3 x 0.5 mm ceramic, copper/platinum wire	
	X1506	Prepacked GC reduction reactor tube 320 x 1.5 x 0.5 mm ceramic, copper wire	1040820
	X7021	Prepacked reactor, Flash HT (ceramic and glassy carbon)	
	X7020	Prepacked TC/EA tube (ceramic and glassy carbon)	1127500

Key

Products are colour coded according to the IRMS technique they are used in, as follows:

- High temperature
- O/H pyrolysis and reduction
- CN-IRMS, S-IRMS, CNS-IRMS
- GC combustion/pyrolysis



The use of OEM part numbers is intended for convenience only, and does not imply that the products are of OEM origin. All Elemental Microanalysis products are guaranteed to be of high quality and are deemed to be suitable alternatives in the stated instruments. All trademarks acknowledged.

O-rings are shown actual size



CF-IRMS analysis O-rings and seals

Part No	Description	Pack	OEM part
E1001	O-ring	10	29030331
E1004	O-ring, nitrile rubber	10	29030042
E1042	Seal, chamfered square profile	5	29030042, SC1421
E1420	O-ring	1	SC0047/SC2418
E1421	O-ring	1	SC0046/SC2419
E1504	O-ring, EVR for reactor 18 mm OD	1	E13536
E1506	O-ring for ceramic reactor 17 mm	1	E13538
E1507	O-ring, EVR for bottom quick fit 17 mm	1	E13539
E1508	O-ring, bottom quick fit 6 mm	1	E13540
E6053	O-ring, TC/EA	1	1121120
E6054	O-ring, pack of 2 for E4405	2	29000063

CF-IRMS products

Separation columns

Part No	Description	OEM part
E3001	Separation column, oxygen, 1 m stainless steel	26007900
E3009	Separation column, oxygen, 1.5 m stainless steel	
E3011	NC separation column for IRMS	26007931
E3030	Separation column, oxygen, 1 m, isoEArth/Integra2	SC2010
E3031	Separation column, NC 0.5 m stainless steel, isoEArth/Integra2	E1004907/SC2011
E3032	Separation column, sulfur, 0.6 m stainless steel, GSL/Integra	SC2012
E3033	Separation column, NC, 0.5 m stainless steel, GSL/Integra	SC2013
E3034	Separation column, sulfur, 0.8 m PTFE, isoEArth/Integra2	SC2461
E3035	GC column, TC/EA, 0.6 m, 1/8" stainless steel	1121030
E3036	Separation column, O/H, 1.5 m stainless steel	E11521
E3037	EuroVector high resolution column (0.7 m) for GC separation of C/N	E11528-IG
E3042	Modified GC column, TC/EA, 1.5 m long	

Modified lower fitting for improved water analysis

The adapter (E4405) channels the helium flow up between the ceramic outer and down through the centre of the glassy carbon tube, ensuring all water vapour is swept down into the reactive zone. Use of this fitting requires a different length glassy carbon inner from standard (C7007).



The use of OEM part numbers is intended for convenience only, and does not imply that the products are of OEM origin. All Elemental Microanalysis products are guaranteed to be of high quality and are deemed to be suitable alternatives in the stated instruments. All trademarks acknowledged.

Parts and accessories

Part No	Description	OEM part
E4405	Bottom feed adapter TC/EA with o-rings	
E4406	TC/EA furnace element	
E4407	TC/EA furnace repair - does not include thermocouple replacement	
E4408	TC/EA furnace assembly	
F5170	Capillary SS 1/16" x 0.8 mm, 2 m	605470

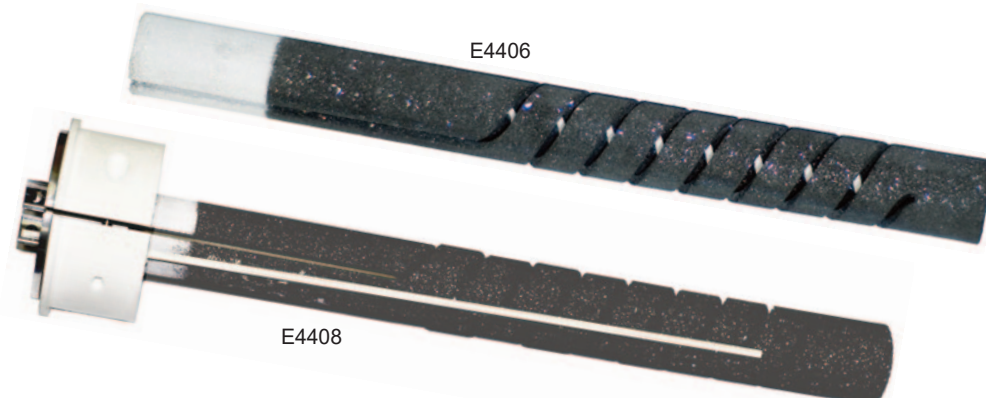

Consumables kits CF-IRMS analysis

Consumable kits provide every consumable you should need for the day-to-day running of your instrument, for the specified type of analysis. Please check our website for the contents of each kit.

Part No	Description	OEM part	
EuroVector	X3250	Consumable kit EuroVector EA - CN 1000 analyses	6063056
	X3251	Consumable kit EuroVector EA - O/H solid samples (high temperature)	6062979
	X3252	Consumable kit EuroVector EA - sulfur 1000 analysis	6062974
	X3253	Consumable kit EuroVector EA - hydrogen spares for liquid samples (low temperature)	6062977
	X3254	Consumable kit EuroVector EA - oxygen spares for liquid samples	6062978
Thermo Fisher Scientific®	Flash IRMS		
	X1115	NC kit, Flash IRMS, 1000 analyses	19003770/1293150
	X1137	Spare parts/consumables, Flash 2000 HT & EA IsoLink CN/OH, OH analysis (3000 analyses)	1185471
	X1139	Kit for 8000 analyses Flash for IRMS / HT NCS analysis	
	Flash HT		
	X1138	Consumables Flash HT and TC/EA, OH-analysis (1000 analyses)	1290340
	X1139	Kit for 8000 analyses Flash for IRMS / HT NCS analysis	
	X7008	Reactor kit Flash HT	1197480
	TC/EA		
	X1136	Spare parts/consumables TC/EA, OH analysis (3000 analyses)	1136820
X1138	Consumables Flash HT and TC/EA, OH analysis (1000 analyses)	1290340	
X7007	Reactor kit TC/EA	1141050	

Equilibrium reagents and sundries

Part No	Description	Pack
B1453	5% Pt on alumina – 325 mesh powder	10 g
E2800	Tapered glass insert for use with B1453 in equilibrium (exchange) reactions	1000

Nafion® dryers

Nafion® water removal dryers can be supplied as complete units or replacement inner elements.

Dryers and elements are supplied with 0.05" OD, 0.04" ID Nafion® tubing.

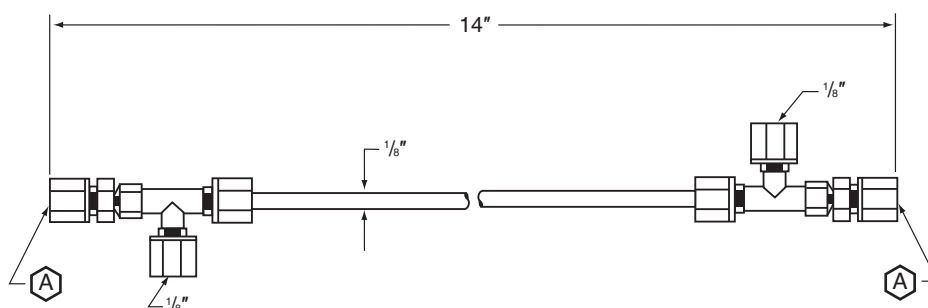







Part No	Description
Complete dryer	
E2810	Nafion® dryer stainless steel body 1/8" end fittings (A)
E2811	Nafion® dryer stainless steel body 1/8" end fittings (A)
E2812	Nafion® dryer fluoropolymer body 1/8" end fittings (A)
E2813	Nafion® dryer polypropylene body 1/8" end fittings (A)
Replacement inner element	
E2820	12" long, 0.05" tubing, polypropylene flanged end pieces
E2821	12" long, 0.05" tubing, fluoropolymer flanged end pieces
E2822	12" long, 0.05" tubing, stainless steel flanged end pieces

The use of OEM part numbers is intended for convenience only, and does not imply that the products are of OEM origin. All Elemental Microanalysis products are guaranteed to be of high quality and are deemed to be suitable alternatives in the stated instruments. All trademarks acknowledged.

Nafion® is a registered trademark of E.I. DuPont.

CF-IRMS analysis Vials, seals and caps

	Part No	Labco No	Description	Pack
	E2830	948W	Non-evacuated, unlabelled, seal + white cap	1000
	E2831	048W	Evacuated, unlabelled, seal + white cap	1000
	E2832	949W	Non-evacuated, labelled, seal + white cap	1000
	E2833	049W	Evacuated, labelled, seal + white cap	1000
	E2834	948W	Non-evacuated, unlabelled, seal + white cap	2000
	E2840	718W	Non-evacuated, unlabelled, seal + white cap	1000
	E2841	818W	Evacuated, unlabelled, seal + white cap	1000
	E2842	719W	Non-evacuated, labelled, seal + white cap	1000
	E2843	819W	Evacuated, labelled, seal + white cap	1000
	E2850	738W	Non-evacuated, unlabelled, seal + white cap	1000
	E2851	838W	Evacuated, unlabelled, seal + white cap	1000
	E2852-0100	739W	Non-evacuated, labelled, seal + white cap	100
	E2852	739W	Non-evacuated, labelled, seal + white cap	1000
	E2853	839W	Evacuated, labelled, seal + white cap	1000
	E2869	837W	Evacuated, labelled, double wadded, white cap	1000
	E2860	938W	Non-evacuated, unlabelled, seal + white cap	1000
	E2861	038W	Evacuated, unlabelled, seal + white cap	1000
	E2862	939W	Non-evacuated, labelled, seal + white cap	1000
	E2863	039W	Evacuated, labelled, seal + white cap	1000
	E2868	737W	Non-evacuated, labelled, double wadded white cap	500
	E2870	428W	Non-evacuated, unlabelled, seal+white cap	1000
	E2871	138W	Evacuated, unlabelled, seal+white cap	1000
	E2872	429W	Non-evacuated, labelled, seal+white cap	1000
	E2873	139W	Evacuated, labelled, seal+white cap	1000
	E2864-0100	9RK8W	Non-evacuated, unlabelled, seal + white cap	100
	E2864	9RK8W	Non-evacuated, unlabelled, seal + white cap	1000
	E2881	0RK8W	Evacuated, unlabelled, seal + white cap.	1000
	E2882	9RK9W	Non-evacuated, labelled, seal + white cap	1000
	E2883	0RK8W	Evacuated, labelled, seal + white cap	1000
	E2867	5RK8W	Non-evacuated, unlabelled, seal + white cap, 500 vials + 1000 caps	500/1000
	E2884	5RK9W	Non-evacuated, labelled, seal + white cap, 500 vials + 1000 caps	500/1000
<p>The wide thread profile of these Exetainer® vials gives a very tight screw fit, and is designed to avoid any cap movement when samples are heated - e.g. on a gas bench.</p>				
<p>Exetainer® septa and caps</p>				
E2865	VW101	Septa		1000
E2866	VC301	Pierceable caps blue		1000
E2885	VC309	Pierceable caps white		1000
E2886	VC306	Pierceable caps orange		1000
E2887	VC303	Pierceable caps grey		1000

Exetainer® is a registered trademark of Labco Ltd.

Reference materials CF-IRMS analysis



Isotope reference materials

Part No	Description	Pack	$\delta^{13}\text{C}$ ‰	$\delta^2\text{H}$ ‰	$\delta^{15}\text{N}$ ‰	$\delta^{18}\text{O}$ ‰	$\delta^{34}\text{S}$ ‰
Interlaboratory Comparison Certified Isotopic Reference Materials ¹							
B2203	IRMS certified reference material EMA P1	3 g	-27.85	-25.30		20.99	-3.01
B2205	IRMS certified reference material EMA P2	3 g	-28.19	-87.80	-1.57	26.88	
B2207	Silver phosphate (Ag_3PO_4) ^{18}O IRMS standard	1 g				21.7	
B2214	Carrara marble powder IRMS standard for ^{13}C & ^{18}O	0.5 g	2.10			-2.01	
Certified Isotopic Reference Materials ²							
B2151	High organic content sediment IRMS standard OAS/isotope	5 g	-28.85		4.32		
B2153	Low organic content soil IRMS standard OAS/isotope	5 g	-22.88		5.78		
B2155	Protein IRMS standard OAS/isotope	5 g	-26.98		5.83		6.18 *
B2157	Wheat flour IRMS standard OAS/isotope	5 g	-27.21		2.73		-2.38 *
B2159	Sorghum flour IRMS standard OAS/isotope	5 g	-13.78		1.58		10.11 *
B2215	Gelatin IRMS standard certified for ^{13}C , ^{15}N , ^{18}O , ^{34}S	2 g	-22.92		4.26	6.76	1.21
Working Standards ³ (Uncertified)							
B2190	^2H and ^{18}O isotope IRMS standard high enriched water	25 ml		2051.96		263.43	
B2191	^2H and ^{18}O isotope IRMS standard medium enriched water	25 ml		1018.39		105.59	
B2192	^2H and ^{18}O isotope IRMS standard zero natural water	25 ml		11.26		-0.41	
B2193	^2H and ^{18}O isotope IRMS standard medium natural water	25 ml		-141.44		-20.09	
B2194	^2H and ^{18}O isotope IRMS standard low natural water	25 ml		-269.07		-33.57	
B2195	^2H and ^{18}O isotope standard, set of 5 water working standards	5 x 25 ml					
B2172	Olive oil isotopic working IRMS standard for ^{13}C	5 g	-29.32				
B2174	Urea isotopic working IRMS standard for ^{13}C , ^{15}N	5 g	-42.18		-0.69		
B2213	Spruce powder IRMS standard for ^{15}N , ^{13}C , ^{18}O	3 g	-25.44		-4.9	23.59	

Analysis values may change depending on the current batch available; please see the website or contact us for information on the current analysis values of reference materials.

Notes

1. Interlaboratory Comparison Certified Isotopic Reference Materials – Certified through an international study involving 6 to 25 laboratories.
 2. Certified Isotopic Reference Materials – Derived from data from two or more instruments in a single testing organisation on two or more runs on different days.
 3. Working Standards (Uncertified) – Using data from a single instrument and intended as "in-run" reference only.
- * Values not certified; given for information only.

Elementar® vario PYRO cube, vario OXY cube

H /H-O /O pyrolysis

Thermo Fisher Scientific®

TC/EA & Flash Instruments (HO analysis)

High temperature pyrolysis

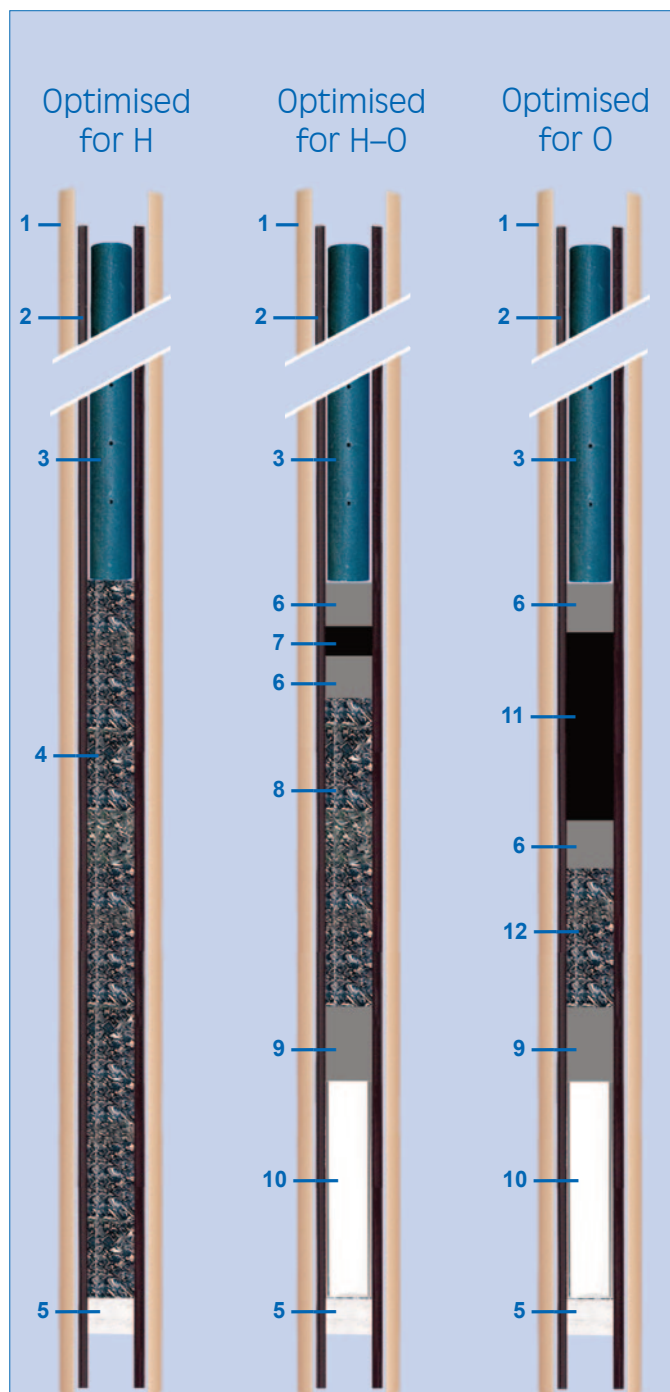

Key				
Product	Qty	OEM no.	Part No.	
1 Ceramic outer tube		23.00-1021	C1106	
2 Glassy carbon tube		23.00-1020	C7017	
3 Ash crucible, graphite		23.00-1189	C3061	
3 (alternative) Ash finger, glassy carbon		15.00-1189	C7018	
4 Glassy carbon chips	195 mm	11.64-0050	C7021	
5 Quartz wool	10 mm	03 679 908	B1208	
6 Graphite felt (one layer)		23.00-0098		
7 Carbon black	8 mm	23.00-0097		
8 Glassy carbon chips	85 mm	11.64-0050	C7021	
9 Graphite felt (two layers)		23.00-0098		
10 Support tube 12 mm OD x 60 mm		15.00-1119	C3072	
11 Carbon black	50 mm	23.00-0097		
12 Glassy carbon chips	35 mm	11.64-0050	C7021	

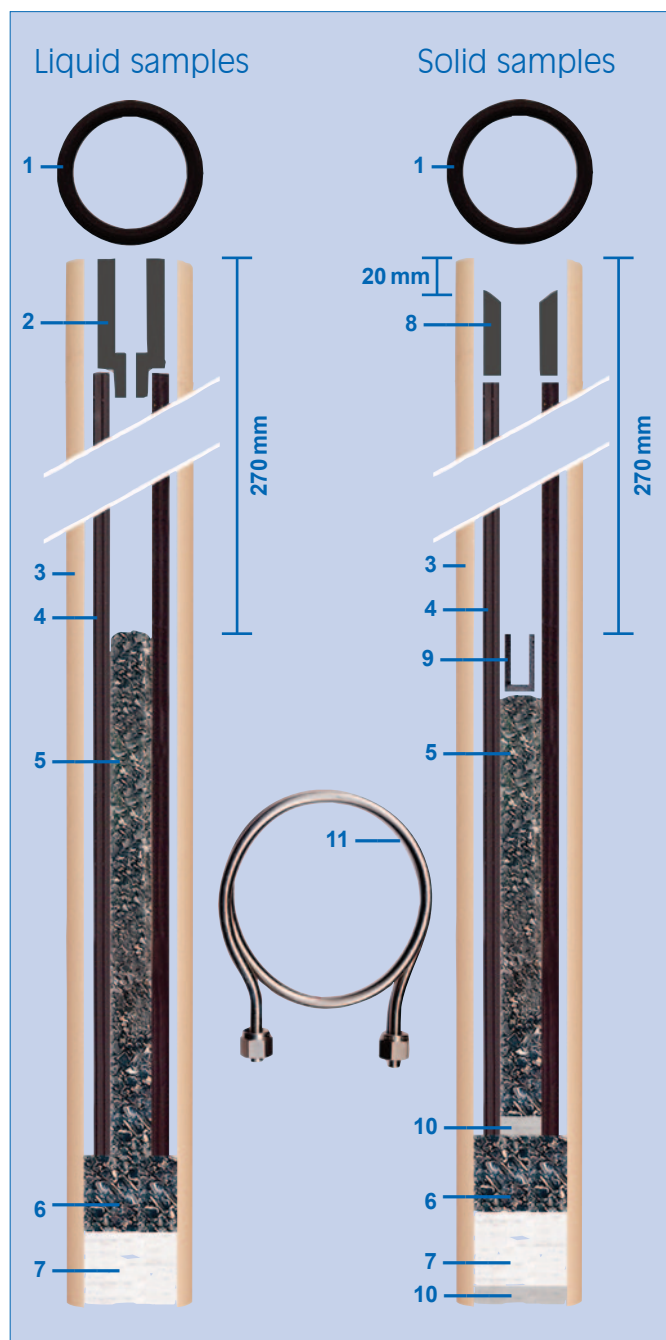

Key				
Product	Qty	OEM no.	Part No.	
1 O-ring		1121120	E6053	
2 Graphite tube		1132080	C7011	
3 Ceramic tube (TC/EA)		1121320	C1101	
3 or ceramic tube (Flash instruments)		1156890	C1105	
4 Glassy carbon tube		1121310	C7001	
5 Glassy carbon chips		1117400	C7002	
6 Glassy carbon chips		1117400	C7002	
7 Silica (quartz) wool, very fine	20 mm	33822200	B1017	
8 Graphite tube		1121351	C7010	
9 Graphite crucible		1117332	C7012	
10 Silver wool, very fine	5 mm	1117430	B1119	
11 GC column TC/EA 0.6 m		1121030	E3035	
or Modified GC column TC/EA 1.5 m long			E3042	

CF-IRMS products

High temperature pyrolysis

H in liquids using chrome catalyst

Oxygen analysis

Hydrogen analysis

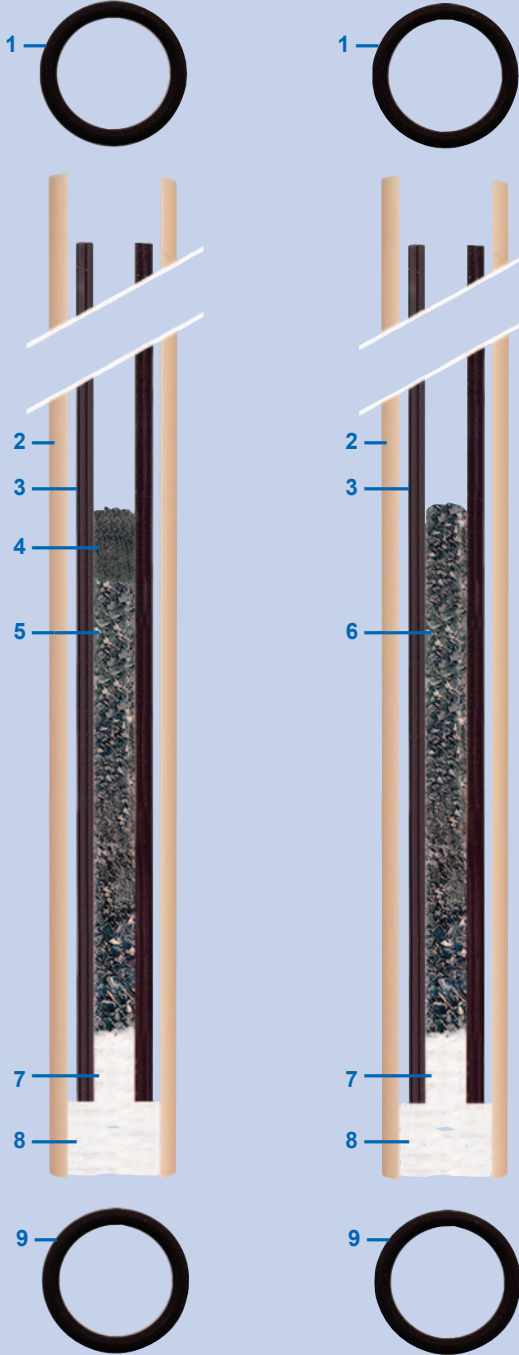

Key

Product	Qty	OEM no.	Part No.
1 O-ring for ceramic reactor 17 mm		E13538	E1506
2 Ceramic tube		E12507	C1102
3 Glassy carbon tube		E12529	C7004
4 Nickelised carbon	20 mm	E10145	B1182
5 Glassy carbon chips	120 mm	E10521	C7003
6 Glassy carbon chips	140 mm	E10521	C7003
7 Silica (quartz) wool, very fine	20 mm	E10514	B1017
8 Silica (quartz) wool, very fine	20 mm	E10514	B1017
9 O-ring for bottom, quick fit, 17 mm		E13539	E1507
10 Separation column O/H 1.5 m		E11521	E3036

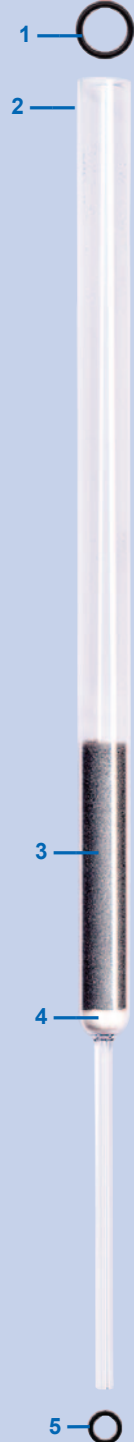

Key

Product	Qty	OEM no.	Part No.
1 O-ring for reactor 18 mm OD		E13536	E1504
2 Reaction tube modified transparent silica		E12512	C1056
3 Chrome catalyst	90 mm	E10103	B1450
4 Silica (quartz) wool very fine	10 mm	E10514	B1017
5 O-ring bottom quick fit 6 mm		E13540	E1508
10 Separation column O/H 1.5 m		E11521	E3036

CF-IRMS
products

Sercon isoEarth/Integra2

N/CN determination

S determination

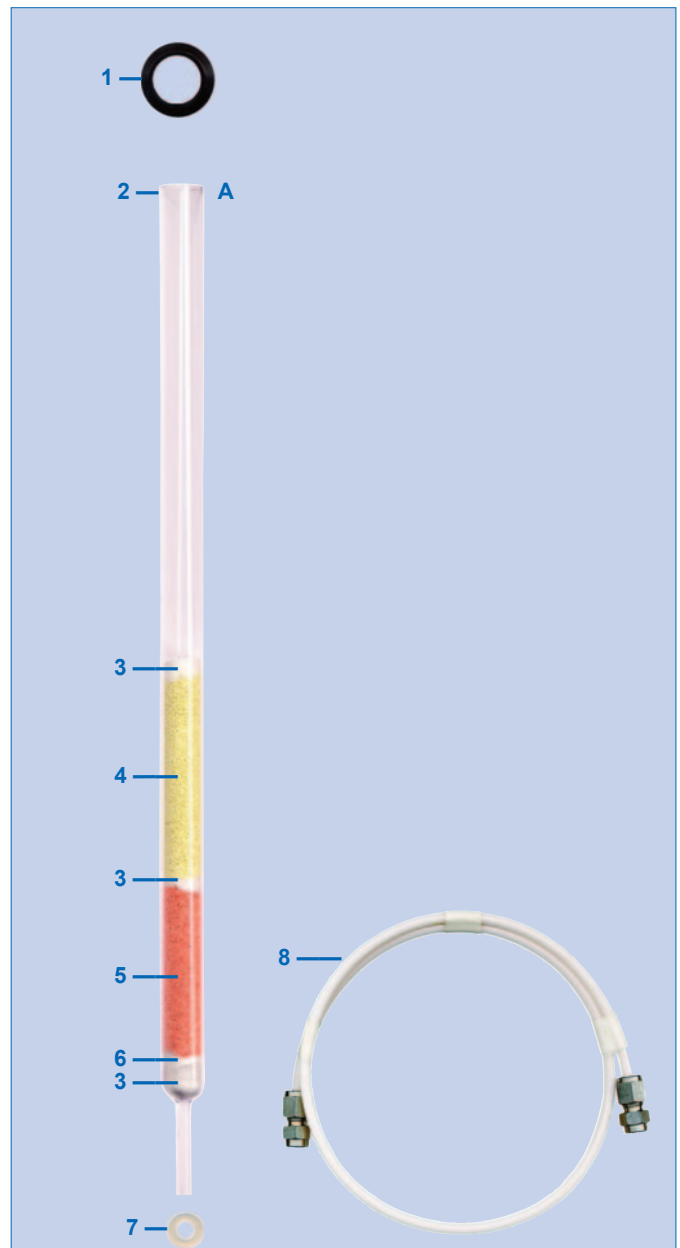
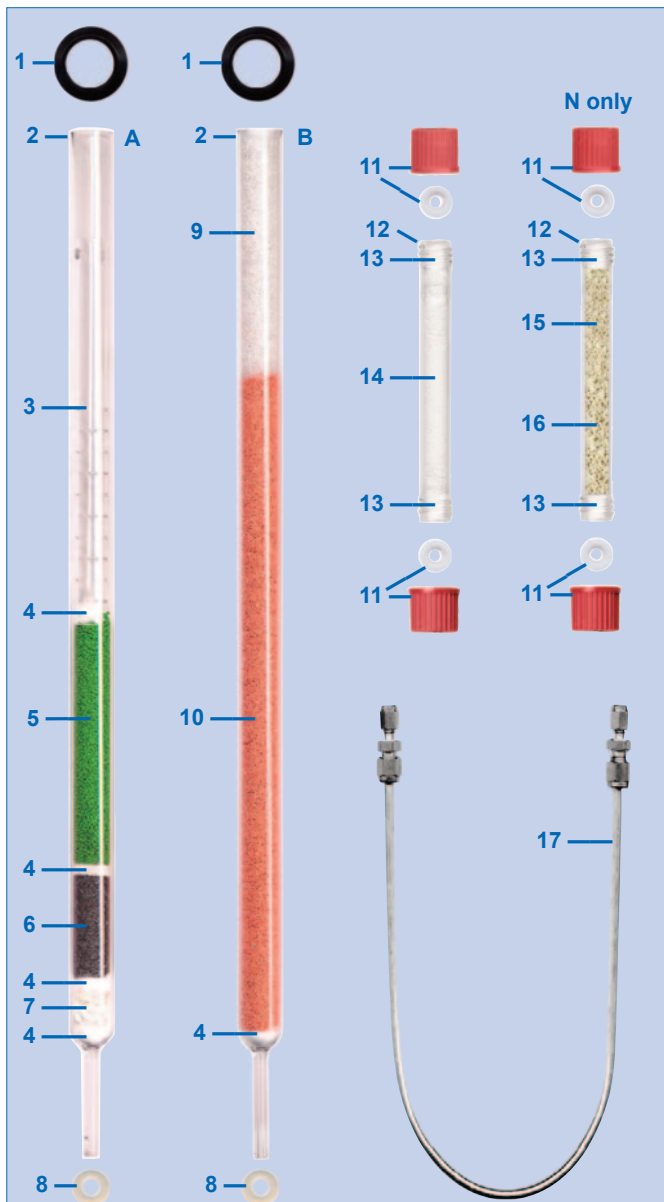

Key

Product	Qty	OEM No.	Part No.
1 Seal chamfered square profile		SC1421	E1042
2 Reaction tube, transparent silica		SC0012	C1039
3 Sleeve insert		SC0011	C1050
4 Quartz wool, very fine	5 mm	SC0006	B1208
5 Chromium oxide	110 mm	SC0001	B1004
6 Copper oxide fine wires	40 mm	SC0003	B1125
7 Silver wool, very fine	20 mm	SC0007	B1119
8 O-ring, lower		SC0047	E1420
9 Quartz chips	100 mm	SC0004	B1008
10 Copper wires, fine	320 mm	SC0002	B1015
11 Cap kit for threaded joints		SC0085	C1020
12 Scrubber tube, threaded, borosilicate glass		SC0084	C1008
13 Quartz wool, very fine	10 mm	SC0006	B1208
14 Magnesium perchlorate		SC0022	B1101
15 EMASorb II B granular	½ tube		B1323
16 EMASorb II A granular	½ tube		B1320
17 Separation column NC 0.5 m			E3031
A Prepacked reaction tube (includes C1050 quartz liner)			X1200
Prepacked reaction tube, heavy wall, (includes C1050 quartz liner)			X1201
B Prepacked reduction tube			X1203
Prepacked reduction tube, heavy wall			X1204

Key

Product	Qty	OEM No.	Part No.
1 Seal chamfered square profile		SC1421	E1042
2 Reaction tube, transparent silica		SC0012	C1039
3 Quartz wool, very fine	5 mm	SC0006	B1208
4 Tungstic oxide/zirconium oxide	90 mm	SC0204	B1082
5 Copper wires, high purity	80 mm	SC0008	B1035
6 Quartz chips	10 mm	SC0004	B1008
7 O-ring, lower		SC0047	E1420
8 Separation column		SC2461	E3034
A Prepacked reaction/reduction tube			X1205

Sercon isoEarth/Integra2

O pyrolysis

H pyrolysis

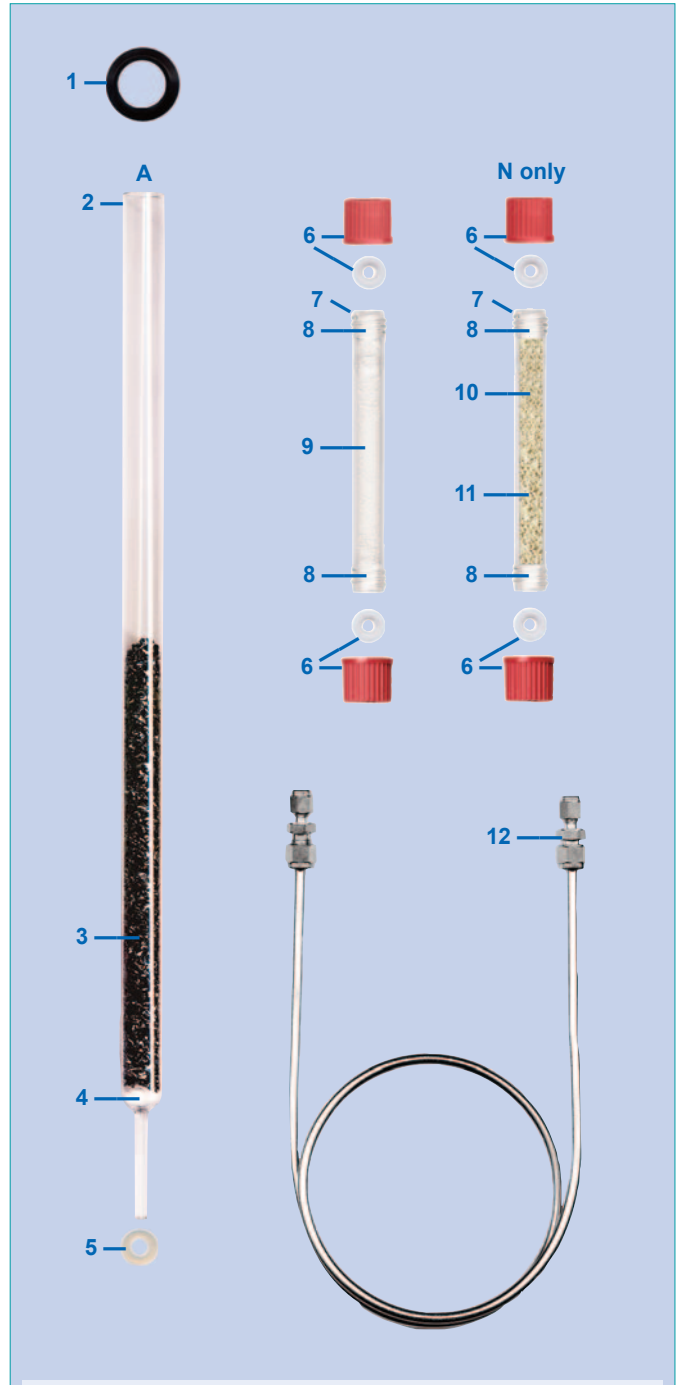
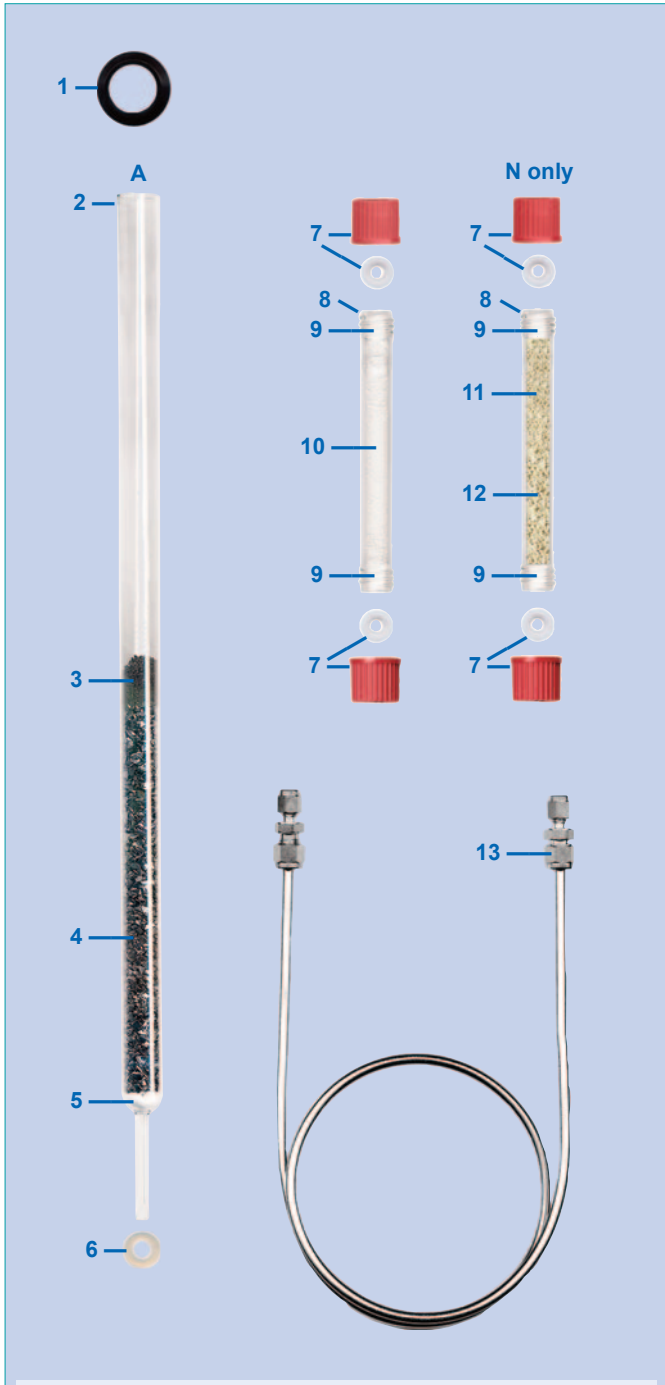

Key			
Product	Qty	OEM No.	Part No.
1 Seal chamfered square profile		SC1421	E1042
2 Reaction tube, transparent silica		SC0012	C1039
3 Nickelised carbon 50% Ni	10 mm	SC0288	B1182
4 Glassy carbon chips 2-3 mm	180 mm	SC0039	C7006
5 Quartz wool, very fine	5 mm	SC0006	B1208
6 O-ring, lower		SC0047	E1420
7 Cap kit for threaded joints		SC0085	C1020
8 Scrubber tube, threaded, borosilicate glass			C1008
9 Quartz wool, very fine	10 mm	SC0006	B1208
10 Magnesium perchlorate		SC0022	B1101
11 EMASorb II B granular	½ tube		B1323
12 EMASorb II A granular	½ tube		B1320
13 Separation column oxygen 1 m			E3030
A Prepacked oxygen pyrolysis tube			X1207

Key			
Product	Qty	OEM No.	Part No.
1 Seal chamfered square profile		SC1421	E1042
2 Reaction tube, transparent silica		SC0012	C1039
3 Glassy carbon chips 2-3 mm	180 mm	SC0039	C7006
4 Quartz wool, very fine	5 mm	SC0006	B1208
5 O-ring, lower		SC0047	E1420
6 Cap kit for threaded joints		SC0085	C1020
7 Scrubber tube, threaded, borosilicate glass			C1008
8 Quartz wool, very fine	10 mm	SC0006	B1208
9 Magnesium perchlorate		SC0022	B1101
10 EMASorb II B granular	½ tube		B1323
11 EMASorb II A granular	½ tube		B1320
12 Separation column oxygen 1 m			E3030
A Prepacked hydrogen pyrolysis tube			X1209

CF-IRMS
products

Sercon isoEarth+

CNS

CF-IRMS products

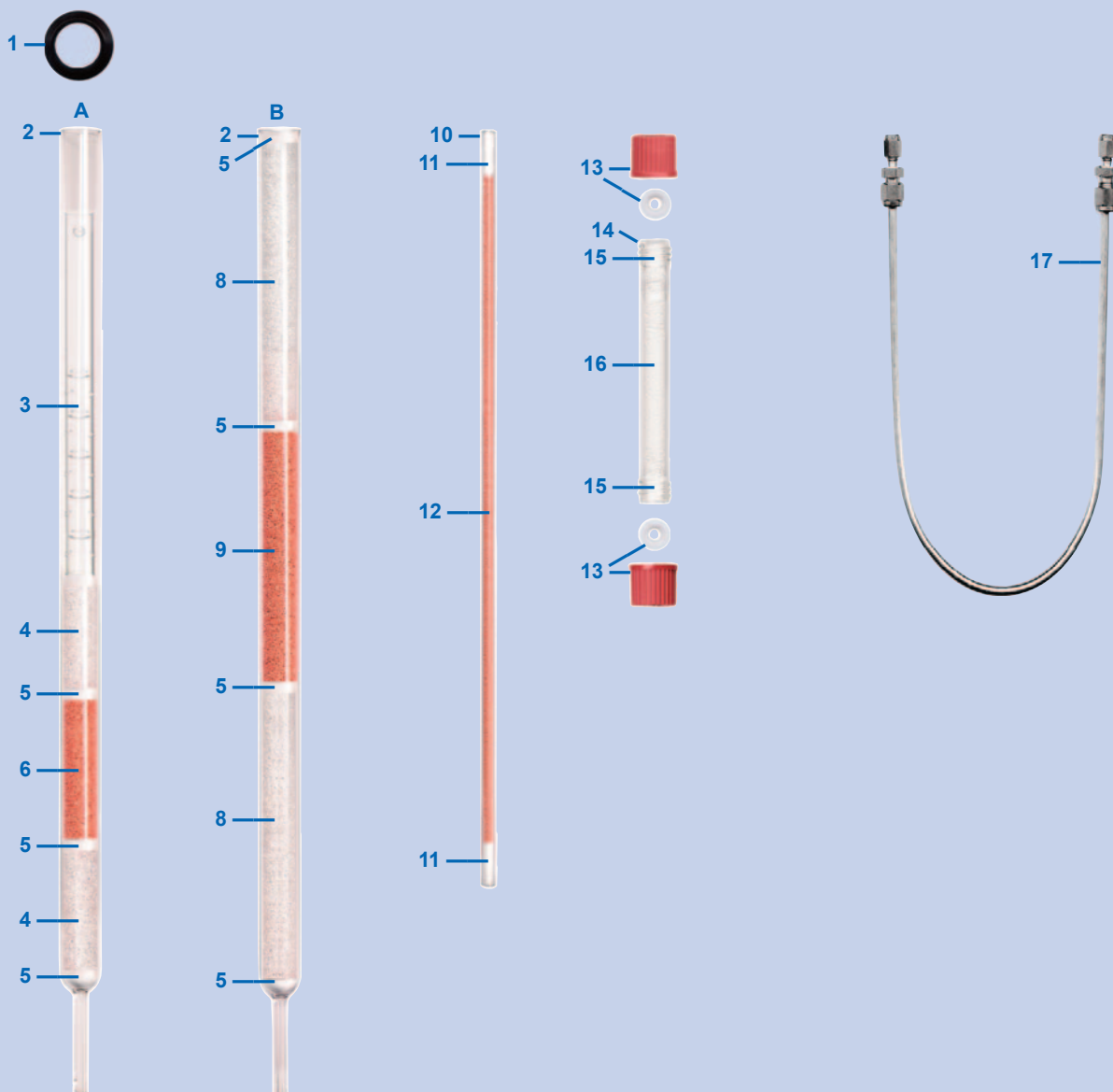

Key				
Product	Qty	OEM No.	Part No.	
1 Seal chamfered square profile		SC1421	E1042	
2 Reaction tube, transparent silica		SC0012	C1039	
3 Sleeve insert		SC0011	C1050	
4 Silica (quartz) chips granular	50 mm	SC0004	B1008	
5 Quartz wool, very fine	5 mm	SC0006	B1208	
6 Copper wires, fine	70 mm	SC0002	B1015	
7 O-ring, lower		SC0047	E1420	
8 Silica (quartz) chips granular	140 mm	SC0004	B1008	
9 Copper wires, fine	120 mm	SC0002	B1015	
10 Reduction tube			C1038	
11 Quartz wool, very fine	20 mm	SC0006	B1208	
12 Copper wires, fine	330 mm	SC0002	B1015	
13 Cap kit for threaded joints		SC0085	C1020	
14 Scrubber tube, threaded, borosilicate glass		SC0084	C1008	
15 Quartz wool, very fine	10 mm	SC0006	B1208	
16 Magnesium perchlorate		SC0022	B1101	
17 Separation column N,C 0.5 m		SC2011	E3031	
18 Separation column 1 m		SC2502	Q10989	
A Prepacked combustion tube (with liner) for isoEarth+			X1212	
B Prepacked equilibration tube for isoEarth+			X1213	

Sercon HT-EA Wave

High temperature pyrolysis

Glassy carbon tube/ceramic tube configuration

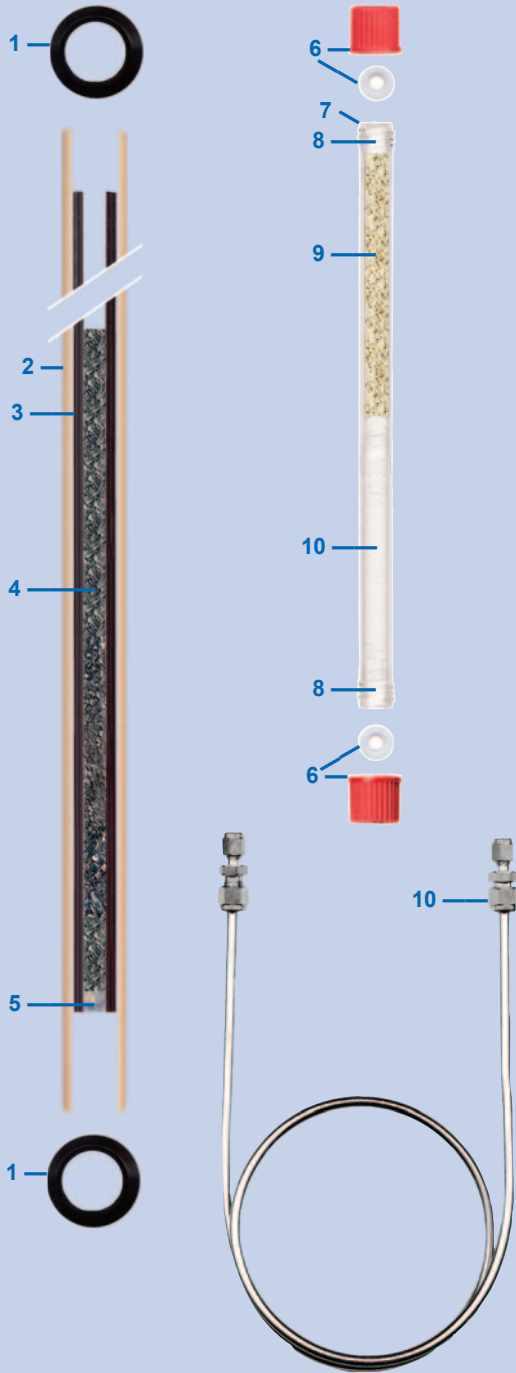

Molybdenum lined ceramic tube configuration

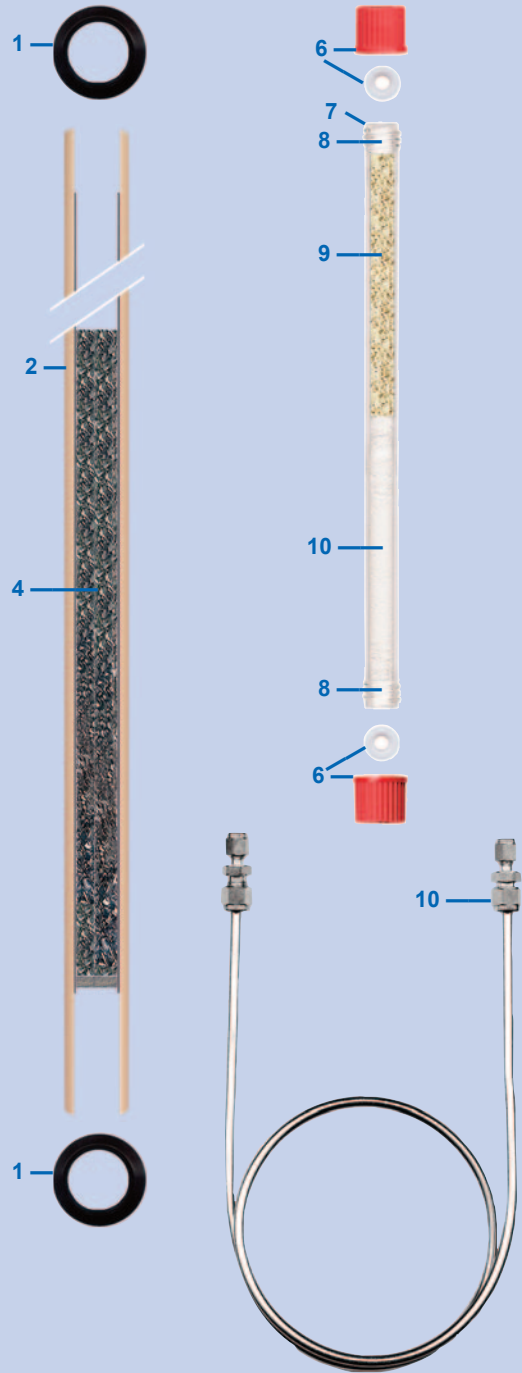

Key				
Product	Qty	OEM no.	Part No.	
1 Seal chamfered square profile		SC1421	E1042	
2 Ceramic tube		SC0694	C1103	
3 Glassy carbon tube		SC0971	C7001	
4 Glassy carbon chips	160 mm	SC0039	C7006	
5 Nickel wool, fine wire	10 mm	SC0151	B1007	
6 Cap kit for threaded joints		SC0085	C1020	
7 GL14 scrubber tube 220 mm		SC2495	C1142	
8 Quartz wool, very fine	10 mm	SC0006	B1208	
9 EMASorb II A granular		SC0236	B1320	
10 Magnesium perchlorate		SC0023	B1141	
11 Separation column oxygen 1 m		SC2010	E3030	

Key				
Product	Qty	OEM no.	Part No.	
1 Seal chamfered square profile		SC1421	E1042	
2 Ceramic tube with molybdenum foil liner		SC2332	X7022	
4 Glassy carbon chips	150 mm	SC0039	C7006	
6 Cap kit for threaded joints		SC0085	C1020	
7 GL14 scrubber tube 220 mm		SC2495	C1142	
8 Quartz wool, very fine	10 mm	SC0006	B1208	
9 EMASorb II A granular		SC0236	B1320	
10 Magnesium perchlorate		SC0023	B1141	
11 Separation column oxygen 1 m		SC2010	E3030	

CF-IRMS
products

HEKAtech HT-O

High temperature pyrolysis

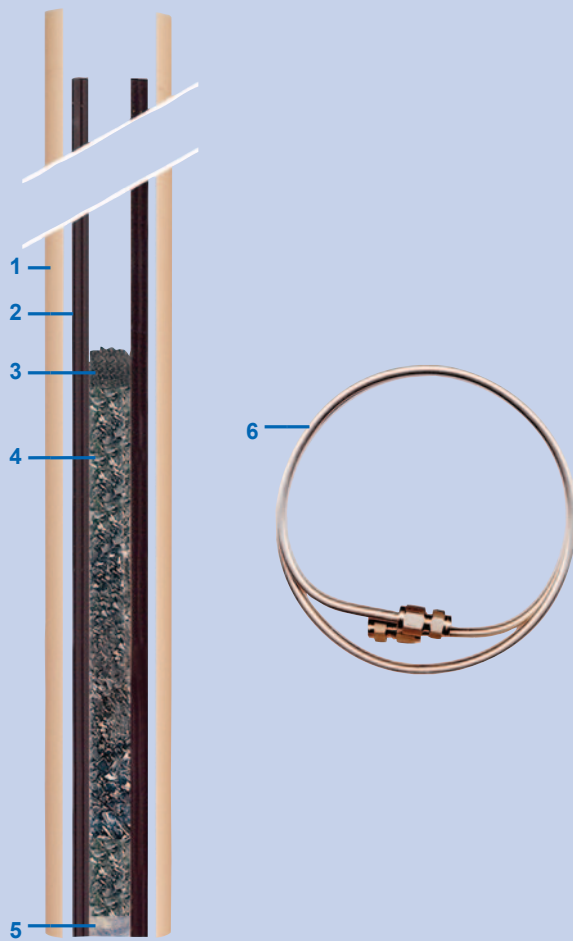

Key

Product	Qty	OEM no.	Part No.
1 Ceramic tube		HE 468110	C1103
2 Glassy carbon tube		HE 46860100	C7004
3 Nickelised carbon	10 mm	HE 33823800	B1182
4 Glassy carbon chips	135 mm	HE 33823850	C7003
5 Nickel wool, fine wire	5 mm	HE 3382500	B1007
6 Separation column oxygen 1 m		HE 26007900	E3001

Cross references Micro CHNOS & CF-IRMS analysis

Elementar®

Elementar® Part	Description	Part No
03 001 118	Sulfanilic acid OAS 5 g	B2147
03 001 248	Forceps stainless steel curved points - length 130 mm	E2016
03 002 267	O-ring rubber, 24 mm x 2 mm	E1075
03 002 267	O-ring rubber, 24 mm x 2 mm, pk of 10	E1075-1010
03 002 395	O-ring for gripper arm	E1171
03 002 399	Filter diameter 18 mm, pk of 1	E1174
03 002 399	Filter diameter 18 mm, pk of 10	E1174-10
03 002 607	Shaft seal	E1555
03 651 011	Tubing PTFE 5 mm OD x 3 mm ID 0.5 m	E1058
03 653 103	O-ring silicone rubber	E1063
03 653 118	O-ring silicone rubber	E1085
03 654 505	O-ring silicone rubber	E1086
03 654 603	O-ring silicone rubber, pk of 10	E1016
03 654 615	O-ring nitrile rubber	E1081
03 654 627	O-ring rubber, 20 mm x 2 mm	E1073
03 654 627	O-ring rubber, 20 mm x 2 mm, pk of 10	E1073-10
03 654 629	O-ring silicone rubber, 25 x 2 mm	E1066
03 654 701	O-ring silicone rubber, 4 mm x 4 mm	E1082
03 654 772	O-ring	E1088
03 654 814	O-ring silicone rubber	E1055
03 667 991	Sealing ring	E1080
03 674 012	Aluminium weighing boats 12 x 4 x 4 mm, pk of 1000	D5132
03 674 016	Aluminium weighing boats 12 x 6 x 6 mm, pk of 500	D5133
03 679 900	EMASorb II A granular 20 to 30 mesh CO ₂ absorbant 500 g	B1316
03 679 900	EMASorb II A granular 20 to 30 mesh CO ₂ absorbant 200 g	B1322
03 679 901	EMADrone magnesium perchlorate 454 g	B1161
03 679 907	Silica (quartz) chips granular 1 to 2 mm 100 g	B1214
03 679 908	Silica (quartz) wool very fine 10 g	B1208
03 679 910	High purity carbon granular 0.3 to 0.85 mm 80 g	B1054
03 679 915	Cerium dioxide granular 100 g	B1219
03 679 941	O-ring silicone rubber	E1090
03 679 942	Acetanilide OAS 5 g	B2114
03 950 005	Spatula micro spoon formed bent	E2291
03 951 619	Smooth wall tin capsules flat base 9 x 3.5 mm, pk of 250	D4132
03 951 620	Smooth wall tin capsules flat base 6 x 3 mm, pk of 250	D4131
03 960 157	Silica gel 1 kg	B1066
03 960 350	Nicotinamide OAS 1 g	B2132
03 968 006	Vacuum grease 50 g	E2240
05 000 043	O-ring silicone rubber	E1062
05 000 044	GL18 screw cap	E2518
05 000 049	GL14 screw cap	E2517
05 000 086	Alumina (aluminium oxide) wool fine 20 g	B1089
05 000 087	Ash finger ceramic rapid N	C3030
05 000 088	Oxygen lance 140 mm	C3011
05 000 092	O-ring, 22 mm x 2 mm	E1061
05 000 094	Gloves pair	E2505
05 000 095	O-ring rubber, 22 mm x 2 mm	E1074
05 000 095	O-ring rubber, 22 mm x 2 mm, pk of 10	E1074-10
05 000 096	O-ring 18 mm x 2 mm	E1072
05 000 140	O-ring nitrile rubber	E1060
05 000 247	Seal for oxygen lances - 10 x 3 mm seals	E1049
05 000 247	Seal for oxygen lances - 10 cm piece, to cut into ~30 seals	E1050
05 000 247	Seal for oxygen lance, pk of 10 (1 m, yields up to 330 seals)	E1050-10
05 000 248	O-ring silicone rubber	E1083
05 000 249	O-ring 4.5 mm x 1.5 mm	E1067

The use of OEM part numbers is intended for convenience only, and does not imply that the products are of OEM origin. All Elemental Microanalysis products are guaranteed to be of high quality and are deemed to be suitable alternatives.

Elementar® Part	Description	Part No
05 000 249	O-ring 4.5 mm x 1.5 mm, pk of 10	E1067-10
05 000 308	Multiwell plate 24 cell flat bottom	E2064
05 000 311	Smooth wall tin capsules round base 20 x 8 mm, pk of 100	D4009
05 000 312	Smooth wall tin capsules flat base 14 x 6.75 mm, pk of 100	D4120
05 000 341	O-ring	E1053
05 000 353	Quadring 7.65 mm x 1.78 mm	E1054
05 000 353	Quadring 7.65 mm x 1.78 mm, pk of 10	E1054-10
05 000 354	Oxygen lance 150 mm	C3012
05 000 359	O-ring 9.19 mm x 2.62 mm	E1070
05 000 368	O-ring 9.25 mm x 1.78 mm	E1071
05 000 368	O-ring 9.25 mm x 1.78 mm, pk of 10	E1071-10
05 000 369	O-ring	E1057
05 000 371	O-ring rubber, 24 mm x 3 mm	E1076
05 000 372	O-ring rubber, 38 mm x 2.5 mm	E1077
05 000 384	Quadring nitrile rubber	E1078
05 000 385	O-ring 7 mm x 1.5 mm	E1068
05 000 385	O-ring 7 mm x 1.5 mm, pk of 10	E1068-10
05 000 400	Benzoic acid OAS 5 g	B2047
05 000 416	O-ring 7.5 mm x 2.5 mm	E1069
05 000 416	O-ring 7.5 mm x 2.5 mm, pk of 10	E1069-10
05 000 425	O-ring, 5 mm x 1.5 mm	E1173
05 000 429	Tin foil squares standard weight 37 x 37 mm, pk of 100	D1068
05 000 429	Tin foil cones standard weight, pk of 100	D9001
05 000 481	Smooth wall tin capsules flat base 11 x 4.75 mm, pk of 250	D4121
05 000 658	Oxygen lance 170 mm	C3013
05 000 699	Copper wires fine wires reduced 4 x 0.5 mm 100 g	B1015M
05 000 814	Al capsules smooth wall flat base 7 x 2.7 mm, pk of 250	D4111
05 000 816	Silver capsules smooth wall 5.5 x 3.5 mm, pk of 250	D4102
05 000 817	Silver capsules smooth wall 9 x 3.5 mm, pk of 250	D4109
05 000 880	Manganese dioxide sulfur reduction in U-tube 10 g	B1204
05 000 900	Silica (quartz) chips granular 2 to 4 mm 50 g	B1215
05 001 039	Copper oxide wires fine wires 4 x 0.5 mm 250 g	B1122
05 001 059	Magnesium perchlorate self ind. granular 0.7-1.2 mm 100 g	B1141
05 001 070	Cobaltous/ic oxide granular 0.85 to 1.7 mm 25 g	B1001
05 001 169	Phenylalanine OAS 25 g	B2148
05 001 302	O-ring, black, 7.59 x 2.62 mm	E1087
05 001 540	Silver capsules pressed 8 x 5 mm, pk of 250	D2008
05 001 715	Cotton wool 50 g	E2516
05 001 727	Smooth wall tin capsules flat base 5.5 x 3.5 mm, pk of 100	D4033
05 001 732	Silver capsules smooth wall 5x2 mm, pk of 250	D4103
05 002 254	O-ring 10.3 mm x 2.4 mm	E1368
05 002 303	Quad-ring, black, 18.2 x 3.53 mm	E1370
05 002 304	Quad-ring, black, 29.74 x 3.53 mm	E1371
05 002 305	O-ring green 17.3 x 2.4 mm	E1373
05 002 306	O-ring, green, 29.5 x 3 mm	E1369
05 002 772	Low organic content soil standard OAS 30 g	B2152
05 002 797	Tin foil cones standard weight, pk of 1500	D9010
05 003 394	Tin capsules pressed standard weight 8 x 5 mm, pk of 250	D1008
05 003 395	Tin capsules pressed standard weight 5 x 3.5 mm, pk of 500	D1002
05 003 396	Silver capsules pressed 5 x 3.5 mm, pk of 500	D2002
05 003 397	Silver capsules pressed 8 x 5 mm, pk of 250	D2008
05 003 398	Silver capsules pressed 11 x 8 mm, pk of 100	D2103
05 003 400	Tin capsules pressed standard weight 11 x 8 mm, pk of 100	D1103
05 005 080	EMADrone magnesium perchlorate 454 g	B1161
05 000 359	O-ring 9.19 mm x 2.62 mm, pk of 10	E1070-10
05000088	Oxygen lance 140 mm, pk of 10	C3011-10
05000231	THAM tris (hydroxymethyl) aminomethane 80 g	B1404
11 001 171/4	Support tube vario-EL	C3016
11,00-1363/4	Ash finger 60 mm stainless steel	C3063
11.00-0053	Set of ball valve half shells vario EL, vario macro (non-cube)	E2530
11.00-0500/4	Manually operated drill	E2521

Elementar® Part	Description	Part No
11.00-1150/4	Combustion/reduction tube	C3009
11.00-1170/4	Ash finger quartz	C3018
11.00-1170/4	Ash finger quartz, pk of 10	C3060
11.00-1172/4	Support tube 65 mm	C3017
11.00-1308/4	Reduction tube vario-EL	C3010
11.00-1319/4	Quartz crucible 30 mm	C3068
11.00-1331/4	Connecting tube 65 mm (includes o-rings)	C3022
11.00-1364/4	Support rod, reduction tube 65 mm	C3053
11.00-1371	Silver weighing boats 12 x 4 x 4 mm, pk of 500	D5039
11.00-5057	Tin boats heavy weight 12 x 4 x 4 mm, pk of 1000	D5140
11.02-0008	Tungsten (VI) oxide granular 60 g	B1217
11.02-0008	Tungsten (VI) oxide granular 300 g	B1299
11.02-0017	Tungsten (VI) oxide powder fine powder 25 g	B4013
11.02-0024	Tungsten (VI) oxide powder 90 g	B4014
11.02-1036/4	Ash finger quartz closed end	C3024
11.02-1036/4	Ash finger quartz closed end, pk of 10	C3070
11.02-1046	Silver weighing boat 6 x 4 x 4 mm, pk of 500	D5127
11.02-1047	Tin weighing boat 6 x 4 x 4 mm, pk of 1000	D5029
11.64-0050	Glassy carbon chips 80 g	C7021
11001317/4	Protection tube	C3021
11001317/4	Protection tube (alternative to C3021 without slits)	C3059
12.00-1009	Tin boats 20 x 10 x 9 mm, pk of 120	D5033
12.01-0032	Tin foil squares standard weight 37 x 37 mm pack of 400	D1116
12.01-0033	Tin foil squares standard weight 50 x 50 mm, pk of 100	D1115
12.01-0033	Tin foil squares standard weight 50 x 50 mm, pk of 500	D1118
15.00-0005	Set of ball valve half shells 10 mm	E2532
15.00-0062	Sulfanilamide OAS 10 g	B2048
15.00-0080	Drying tube 300 mm (tube only, no caps)	C1143
15.00-1119	Support tube 12 mm OD x 60 mm	C3072
15.00-1189	Ash finger - high temperature PYRO cube	C7018
15.00-1234	Drying tube 300 mm (tube only, no caps)	C1143
21.00-0008	Set of ball valve half shells 14 mm for vario MACRO cube	E2533
22 127 245/3	Reduction tube rapid CHN	C3005
22 127 313/4	Receptacle insert CHN rapid	D6001
22 131 365	Silver wool 0.05 mm fine wire 50 g	B1231
22 133 210/3	Pyrolysis tube vario-EL	C3019
22 133 211/4	Pyrolysis tube insert vario-EL	C3020
22 133 212	Silver weighing boats 12 x 6 x 6 mm, pk of 100	D5026
22 133 213	Silver weighing boats 15 x 8 x 8 mm pack of 70	D5034
22 133 214	Silver weighing boats 20 x 10 x 9 mm pack of 42	D5035
22 137 418	Tin boats 12 x 4 x 4 mm, pk of 1000	D5130
22 137 419	Tin boats 12 x 6 x 6 mm, pk of 500	D5131
22 137 420	Tin boats 15 x 8 x 8 mm, pk of 250	D5032
22 156 202/3	Combustion tube rapid CHN	C3004
22 160 200/4	Drying guard tube borosilicate (tube only, no caps)	C3008
22 160 204/4	Drying tube with GL 14 end caps	C3066
22 160 301/4	Purification u tube vario-EL	C3015
23.00-0080	U-tube GL14	C3123
23.00-0081	Drying tube 300 mm (tube only, no caps)	C1143
23.00-1020	Glassy carbon tube PYRO cube	C7017
23.00-1021	Ceramic tube PYRO cube	C1106
23.00-1148	Support rod 175 mm vario PYRO cube	C3052
23.00-1189	Ash crucible graphite	C3061
23.00-1230	Drying tube	C3125
25.00-0074	Silver squares 35 x 35 mm, pk of 100	D2084
25.00-1028	Combustion tube quartz vario MAX	C3044
34 00-1339/4	U-tube large complete with GL18 caps	C3038

The use of OEM part numbers is intended for convenience only, and does not imply that the products are of OEM origin. All Elemental Microanalysis products are guaranteed to be of high quality and are deemed to be suitable alternatives.

Elementar® Part	Description	Part No
34.00-0051/4	Powder filling funnel (small) with silicone tubing outlet	E2526
34.00-0052	Tin foil squares standard weight 50 x 50 mm, pk of 1500	D1119
34.00-0099/4	Powder filling funnel (large) with silicone tubing outlet	E2527
38.00-0124	Brass wool 50 g	B1304
38.00-1290	Ash crucible quartz	C3054
41.01-0002/4	Manual press 10.5 mm pellet diameter	E2537
41.01-0003/4	Manual press 7 mm pellet diameter	E2535
41.01-0004	Manual press 9 mm pellet diameter	E2536
50 008 467	Alumina (aluminium oxide) spheres 3 to 6 mm 50 g	B1090
50 009 375/4	Filter tube	C3045
unicu-4k-CHNS/CNS	Elementar consumables kit for unicum	X3051

Europa®

Europa® Part	Description	Part No
C1001004	Chromium oxide granular 0.85 to 1.7 mm 25 g	B1004
C1001005	Chromosorb W 30-60 mesh acid washed 10 g	B3015
C1001006	Copper wires fine wires reduced 4 x 0.5 mm 100 g	B1015
C1001007	Copper oxide fine wires 4 x 0.5 mm 100 g	B1125
C1001008	Magnesium perchlorate granular 0.7 to 1.2 mm 100 g	B1101
C1001009	Nickel sheet 130 x 130 mm x 0.13 mm for tube lining	B1024
C1001014	Reduction tube transparent silica roboprep	C1030
C1001016	Silica (quartz) wool very fine 10 g	B1208
C1001017	Silica (quartz) chips granular 0.85 to 1.7 mm 50 g	B1008
C1001018	Silver wool very fine wire unreel 89 sqcm/g 10 g	B1119
C1001019	Tin capsules pressed standard weight 8 x 5 mm, pk of 250	D1008
C1001019	Tin capsules pressed standard weight 9 x 5 mm, pk of 250	D1021
C1001020	Tin capsules pressed standard weight 6 x 4 mm, pk of 500	D1006
C1001021	Tin capsules pressed standard weight 12.5 x 5 mm, pk of 200	D1010
C1001022	Tin capsules pressed standard weight 12 x 6 mm, pk of 200	D1012
C1001023	Tin capsules pressed standard weight 20 x 8 mm, pk of 100	D1011
C1001024	Tin foil discs standard weight 21 mm diameter, pk of 100	D1064
C1001025	Tungstic oxide on alumina granular 0.85 to 1.7 mm 25 g	B1031
C1001026	Vanadium pentoxide fine powder sample additive 10 g	B4001
C1001036	Forceps stainless steel straight points - length 130 mm	E2017
C1001037	Forceps stainless steel curved points - length 130 mm	E2016
C1001038	Spatula stainless steel 150 x 3 mm	E2000
C1001039	Smooth wall tin capsules flat base 5.5 x 3.5 mm, pk of 100	D4033
C1001042	Copper wires for S analysis high purity 4 x 0.5 mm 40 g	B1035
C1001045	Multiwell plate 96 cell flat bottom	E2044
C1001048	Sleeve insert open both ends 15 x 180 mm Europa	C1050
C1001072	Silver capsules ultra-clean pressed 6 x 4 mm, pk of 250	D2028
C1001073	Silver capsules pressed 12.5 x 5 mm, pk of 200	D2010
C1001073	Silver capsules pressed 12.5 x 5 mm light weight, pk of 100	D2310
C1001085	Tin capsules pressed ultra-light weight 6 x 4 mm, pk of 100	D1016
C1001086	Tin capsules ultra-clean pressed ultra-light weight 6 x 4 mm, pk of 100	D1035
C1001087	Tin foil discs standard weight 16 mm diameter, pk of 100	D1063
C1001088	Tin foil discs standard weight 11 mm diameter, pk of 100	D1060
C1001089	Silver capsules pressed 6 x 4 mm, pk of 500	D2006
C1001089	Silver capsules pressed 6 x 4 mm light weight, pk of 500	D2306
C1001090	Silver capsules pressed 6 x 4 mm, pk of 100	D2007
C1001090	Silver capsules pressed 6 x 4 mm light weight, pk of 100	D2307
C1001091	Silver capsules pressed 8 x 5 mm, pk of 250	D2008
C1001091	Silver capsules pressed 8 x 5 mm light weight, pk of 250	D2308
C1001092	Silver capsules pressed 8 x 5 mm, pk of 100	D2009
C1001092	Silver capsules pressed 8 x 5 mm light weight, pk of 100	D2309
C1001093	Silver capsules ultra-clean pressed 6 x 4 mm pk of 96	D2027
C1001094	Silver discs 16 mm diameter, pk of 100	D2063

Cross references Micro CHNOS & CF-IRMS analysis

Europa® Part	Description	Part No	EuroVector Part	Description	Part No
C1001095	Aluminium capsules ultra-clean pressed 8x5 mm pk of 96	D3029	C10-048	Silver capsules smooth wall 9x3.5 mm, pk of 250	D4109
C1001096	Smooth wall tin capsules flat base 5.5x2 mm, pk of 100	D4000	C10-059	Reaction tube Eurovector pk of 2	C1074
C1001097	Smooth wall tin capsules flat base 6x3 mm, pk of 100	D4001	C10-060	Reaction tube Eurovector heavy wall, pk of 2	C1199
C1001098	Magnesium perchlorate self ind. granular 0.7–1.2 mm 100 g	B1141	C10-061	Quartz insert for 18 mm reactor (220 mm), pk of 2	C1125
E1000608	Copper gasket 64 mm, pk of 5	E2780	C10-062	Quartz liner for 18 mm reactor (245 mm), pk of 2 (for use with C10-081/C10-084)	C1124
E1000609	Copper gasket 38 mm, pk of 5	E2781	C10-064	Quartz empty reactor 20/6 (1pcs)	C1126
E1002527	Platinised copper oxide 10% Pt isotope grade granular 0.2 to 0.5 mm 2 g	B1030	C10-065	Ceramic tube for Eurovector, pk of 2	C1102
E1004907	Separation column NC 0.5 m stainless steel	E3031	C10-071	Modified quartz reactor 18/6	C1155
EuroVector			C10-081	Prepacked tube EA3000 CHN 18/6 single tube system	X1250V
EuroVector Part	Description	Part No	C10-084	Packed reactor for CHNS	X1074V
204009	Sleeve PTFE OD 2 mm set of 10	F4541	C10-097	Trap Eurovector 10 ml	C1148
6062974	Consumable kit - sulfur 1000 analysis	X3252	C10-098	Trap Eurovector 20 ml	C1149
6062977	Consumable kit - hydrogen, spares for liquid samples (low temperature)	X3253	C10-101	GL14 screw cap	E2517
6062978	Consumable kit - oxygen, spares for liquid samples	X3254	C10-161	Prepacked tube for CHNS	X1077V
6062979	Consumable kit - O/H solid samples, (high temperature)	X3251	C10-166	Standards kit CHNS/CHNS-O cystine, sulfanilamide, BBOT, sulfanilic acid 4x0.5 g	B2131
6063056	Consumable kit - CN 1000 analysis	X3250	C10-167	Tin capsules pressed standard weight 9x5 mm, pk of 250	D1021
A02-009	Parker seal 20 mm	E1518	C10-168	Gc column PTFE-1 m-CHNS	E3046V
A04-054	Parker seal 8 mm	E1519	C10-169	Prepacked reactor for CHN (1pcs)	X1267V
C09-007	Copper rod 140 mm	D6006	C10-170	Gc column PTFE-2 m-CHNS	E3047V
C09-012	Reaction tube heavy wall	C1099	C10-171	Prepacked oxygen pyrolysis tube	X1256
C09-015	EA3100 12 mm tube for trap	C1154	C10-173	Trap for H ₂ O (10 g) Eurovector	X1184
C09-016	Quartz tube 25/6 mm	C1153	C10-174	Trap for CO ₂ (10 g) Eurovector	X1185
C10-001	Chromium oxide granular 0.85 to 1.7 mm 25 g	B1004	C10-176	Standards kit C10-176 CHN/CHN-O, acetanilide, EDTA, urea, aspartic acid 4x0.5 g	B2134
C10-004	Copper wires coarse wires reduced 6x0.65 mm 100 g	B1016	C10-177	Silver capsules pressed 8x5 mm, pk of 100	D2009
C10-005	Copper wires for S analysis coarse high purity reduced 6x0.65 mm 100 g	B1053	C10-178	Tin capsules pressed standard weight 8x5 mm, pk of 250	D1008
C10-006	Nickelised carbon 30% Ni granular 0.3 to 0.85 mm 2.5 g	B1454	C10-179	Quartz liner for 18 mm reactor (235 mm), pk of 2 (to use with C10-161/C10-169)	C1128
C10-007	Tungstic oxide granular 0.85 to 1.7 mm 25 g	B1025	C10-180	Quartz liner for 18 mm reactor (200 mm), pk of 2 (to use with C10-161/C10-169)	C1129
C10-009	Cobaltous(ic) oxide silvered granular 0.85 to 1.7 mm 25 g	B1000	C10-183	Tin weighing pans/capsules pressed standard weight, 10x10 mm, pk of 100	D5055
C10-012	Chromosorb W 30-60 mesh acid washed 10 g	B3015	C10-184	Standards kit CHN/CHN-O, acetanilide, EDTA, benzoic acid, aspartic acid 4x0.5 g	B2061
C10-014	Magnesium perchlorate granular 0.7 to 1.2 mm, H ₂ O absorbant 25 g	B1019	C10-185	Prepacked oxygen pyrolysis tube	X1078
C10-015	EMASorb II B granular 8 to 20 mesh CO ₂ absorbant 25 g	B1323	C10-186	Quartz crucible 13 x 70 mm	C1156
C10-016	Silica (quartz) chips granular 0.85 to 1.7 mm 100 g	B1271	C10-187	GC column SS - 1.5 m - 6 x 5 mm for (O-H)	E3050V
C10-017	Silica (quartz) wool very fine 5 g	B1017	C10-188	Silver capsules smooth wall 5.5x3.5 mm, pk of 250	D4102
C10-021	EDTA OAS 1 g	B2033	C10-191	Prepacked reactor for CN, combustion,	X1248V
C10-023	2,5-bis(5-tert-butyl-2-benzo-oxazol-2-yl) thiophene, (BBOT) OAS 1 g	B2044	C10-192	Prepacked reactor for CN, reduction,	X1249V
C10-025	Sulfanilamide OAS 1 g	B2036	C11-028	CHN consumables kit for 1000 analyses	X3267
C10-026	Acetanilide OAS 1 g	B2000	C11-037	Consumables kit for 1000 (CHN) dual analyses	X3269
C10-028	Gc column SS - 2 m 6 x 5 mm (CHNS) (1 pcs)	E3045V	C11-062	(CHNS) (S) consumables kit for 1000 analyses	X3258
C10-030	Gc column PTFE - 1 m - 8 x 6 mm (CHNS) (1 pcs)	E3049V	C11-063	CHN consumables kit for 1000 analyses	X3265
C10-033	Gc column SS - 1.5 m - 6 x 5 mm for (O-H);(h)(o)(1pcs)	E3051V	C11-065	Oxygen consumables kit for 1000 analyses	X3262
C10-039	Tin capsules pressed standard weight 5x3.5 mm, pk of 250	D1005	C11-071	(N-prot) consumables kit for 1000 analyses	X1269
C10-041	Tin capsules pressed standard weight 9x5 mm, pk of 100	D1023	C11-073	(CN) dual consumables kit for 1000 analyses	X3271
C10-042	Tin capsules pressed standard weight 9x5 mm, pk of 200	D1026	E10101	Chromium oxide granular 0.85 to 1.7 mm 25 g	B1004
C10-043	Tin weighing pans/capsules pressed standard weight 10x10 mm, pk of 50	D5101	E10102	Chromium oxide on alumina granular 0.85 to 1.7 mm 50 g	B1131
C10-044	Smooth wall tin capsules flat base 5x2 mm, pk of 50	D4004	E10103	Chrome catalyst 100 g	B1450
C10-045	Smooth wall tin capsules flat base 6x3 mm, pk of 100	D4001	E10105	Cobaltous/ic oxide granular 0.85 to 1.7 mm 25 g	B1001
C10-046	Silver capsules pressed 5x3.5 mm light weight, pk of 100	D2303	E10108	Copper oxide wire (coarse) 100 g	B1234
C10-047	Silver capsules pressed 9x5 mm, pk of 100	D2015	E10109	Copper oxide fine wires 4x0.5 mm 100 g	B1125
			E10120	Copper wires coarse wires reduced 6x0.65 mm 50 g	B1046
			E10121	Copper wires coarse wires reduced 6x0.65 mm 100 g	B1016
			E10130	Copper wires for S analysis coarse high purity, reduced 6x0.65 mm 50 g	B1052
			E10131	Copper wires for S analysis coarse high purity, reduced 6x0.65 mm 100 g	B1053

The use of OEM part numbers is intended for convenience only, and does not imply that the products are of OEM origin. All Elemental Microanalysis products are guaranteed to be of high quality and are deemed to be suitable alternatives.

EuroVector Part	Description	Part No	EuroVector Part	Description	Part No
E10142	Nickel oxide granular 0.85 to 1.7 mm 25 g	B1034	E12501	Reaction tube transparent silica	C1000
E10145	Nickelised carbon 50% Ni granular 0.85 to 1.7 mm 5 g	B1182	E12505	Reduction 'u' tube transparent silica	C1003
E10146	Nickelised carbon 30% Ni granular 0.3 to 0.85 mm 5 g	B1086	E12507-IG	Ceramic tube for Eurovector, pk of 2	C1102
E10146	Nickelised carbon 30% Ni granular 0.3 to 0.85 mm 2.5 g	B1454	E12509	Reaction tube Eurovector, pk of 2	C1074
E10148	N/protein oxidation catalyst copper oxide/platinised alumina 40g	B1103	E12510	Reaction tube Eurovector heavy wall transp. silica	C1099
E10152	Tungstic oxide granular 0.85 to 1.7 mm 25 g	B1025	E12510	Reaction tube Eurovector heavy wall transp. silica, pk of 2	C1199
E10156	Tungstic oxide on alumina granular 0.85 to 1.7 mm 25 g	B1031	E12512	Modified quartz reactor 18/6	C1155
E10160	Cobaltous(ic) oxide silvered granular 0.85 to 1.7 mm 25 g	B1000	E12525	Quartz reactor transparent 20/6 mm OD	C1088
E10182	Vanadium pentoxide fine powder sample additive 10 g	B4001	E12530	Sleeve insert open both ends, 13 mm OD x 220 mm	C1096
E10184	Vanadium pentoxide fine powder sample additive 1 g	B4010	E12531	Quartz insert for 18 mm reactor (220 mm), pk of 2	C1125
E10502	Soda lime granular 1 to 2.5 mm self-indicating, CO ₂ absorbant 100 g	B1211	E12531	Scrubbing tube kit water	E2350
E10504	Chromosorb W 30-60 mesh acid washed 10 g	B3015	E12532	Sleeve insert 245 mm closed one end, pk of 2	C1097
E10504	Chromosorb W 30-60 mesh acid washed 25 g	B3017	E12532	Quartz liner for 18 mm reactor (245 mm), pk of 2	C1124
E10506	Magnesium perchlorate granular 0.7 to 1.2 mm, H ₂ O absorbant 100 g	B1101	E12532	Sleeve insert 245 mm open both ends, pk of 2	C1137
E10507	Magnesium perchlorate granular 0.7 to 1.2 mm, H ₂ O absorbant 25 g	B1019	E13005	Prepacked combustion tube EA3000 CHN/CN/N	X1258
E10508	Molecular sieve 3A 1/16 pellets 100 g	B1047	E13010	Prepacked reduction tube EA3000 CHN/CN/N	X1260
E10508	EMASorb II B granular 8 to 20 mesh CO ₂ absorbant 25 g	B1323	E13025	Prepacked oxygen pyrolysis tube EA3000	X1266
E10510	Nickel wool fine wire 2 g	B1007	E13030	Prepacked tube EA3000 CHN single tube system	X1262
E10512	Silica (quartz) chips granular 0.85 to 1.7 mm 100 g	B1271	E13036	Prepacked combustion tube EA3000 CHN/CN/N18/6	X1252
E10513	Silica (quartz) chips granular 0.85 to 1.7 mm 50 g	B1008	E13037	Prepacked reduction tube EA3000 CHN/CN/N18/6	X1254
E10514	Silica (quartz) wool very fine 5 g	B1017	E13040	Prepacked tube CHNS/NCS/S	X1074
E11002	4-fluorobenzoic acid OAS 1 g	B2013	E13040	Packed reactor for CHNS	X1074V
E11003	Urea OAS 1 g	B2038	E13041	Prepacked tube EA3000 CHN 18/6 single tube system	X1250
E11004	Anthracene OAS 1 g	B2003	E13041	Prepacked tube EA3000 CHN 18/6 single tube system	X1250V
E11005	EDTA OAS 1 g	B2033	E13043	Prepacked oxygen pyrolysis tube	X1256
E11006	8-hydroxyquinoline OAS 1 g	B2020	E13501	Scrubber tube water threaded borosilicate glass	C1008
E11008	Atropine OAS 1 g	B2002	E13501	Trap Eurovector 10 ml	C1148
E11009	Cystine OAS 1 g	B2035	E13502	Scrubber tube water threaded borosilicate glass	C1008
E11012	2,5-bis(5-tert-butyl-2-benzo-oxazol-2-yl) thiophene, (BBOT) OAS	B2044	E13502	Small trap with o-rings, threaded caps and fitting, (to take 2 mm tubing nuts)	E6101
E11016	Benzoic acid OAS 1 g	B2004	E13505	Scrubber tube carbon dioxide threaded borosilicate glass	C1014
E11020	Cyclohexanone 2,4-dinitrophenylhydrazone 1 g	B2005	E13515	Cap kit for threaded joints, caps, PTFE-backed silicone seals, pk of 2	C1020
E11028	Sulfanilamide OAS	B2036	E13515	GL14 screw cap	E2517
E11029	Acetanilide OAS 1 g	B2000	E13520	O-ring for 10/11 mm OD, pk of 10	E1500
E11036-A	Soil standard (sandy) 30 g	B2180	E13525	O-ring for 6 mm OD, pk of 10	E1501
E11037-A	Medium organic content soil standard OAS 30 g	B2178	E13530	O-ring, pk of 10	E1502
E11052-C	Lubricant standard 2 g	B2145	E13535	O-ring, pk of 10	E1503
E11521	Separation column O/H 1.5 m stainless steel	E3036	E13535	O-ring EVR for holder, pk of 2	E1503
E12001	Tin capsules pressed standard weight 5x3.5 mm, pk of 500	D1002	E13536	O-ring EVR for reactor 18 mm OD	E1504
E12001	Tin capsules pressed standard weight 5x3.5 mm, pk of 250	D1005	E13537	O-ring EVR for bottom quick fit 18 mm	E1505
E12003	Tin capsules pressed standard weight 5x3.5 mm, pk of 100	D1003	E13538	O-ring for ceramic reactor 17 mm	E1506
E12005	Tin capsules pressed standard weight 8 x 5 mm, pk of 100	D1009	E13539	O-ring EVR for bottom quick fit 17 mm	E1507
E12005	Tin capsules pressed standard weight 9 x 5 mm, pk of 100	D1023	E13540	O-ring bottom quick fit 6 mm	E1508
E12007	Tin capsules pressed standard weight 9 x 5 mm, pk of 200	D1026	E18-004	Sealing device for liquids	F5109
E12010	Tin weighing pans/capsules pressed standard weight, 10 x 10 mm, pk of 50	D5101	E22509	Quartz empty reactor 20/6 (1pcs)	C1126
E12020	Smooth wall tin capsules flat base 5 x 2 mm, pk of 50	D4004	E23-003	Solid sample preparation kit	X5153
E12020	Smooth wall tin capsules flat base 5 x 2 mm, pk of 100	D4042	EA204009	2x1 mm PTFE ferrule (1pcs)	E2149
E12025	Smooth wall tin capsules flat base 6 x 3 mm, pk of 100	D4001	EA213534	Fine o-ring for holder/cap tightness Eurovector	E1524
E12050	Silver capsules pressed 5 x 3.5 mm, pk of 100	D2003	EA213536	O-ring or 17.86 x 2.62-sil	E1513
E12050	Silver capsules pressed 5 x 3.5 mm light weight, pk of 100	D2303	EA213537	O-ring 18 x 2.65, -ISO3601G-FKM80	E1515
E12055	Silver capsules pressed 9 x 5 mm, pk of 100	D2015	EA213539	O-ring 17,13 x 2, 62-ISO3601G	E1517
E12055	Silver capsules pressed 8 x 5 mm light weight, pk of 100	D2309	EA213540-G	O-ring OR3021-FPM	E1511
E12060	Silver capsules smooth wall 9 x 3.5 mm, pk of 250	D4109	EA213542	O-ring Schott type silicone/PTFE, pk of 10	E1021
			EA213542	O-ring 8 x 2.65, -ISO3601G-NBR	E1516
			EA213545	O-ring 10.6 x 1.8, -ISO3601	E1522
			EA213546	Parker seal 20 mm	E1518
			EA213549	O-ring OR2050-silicon	E1510
			EA213550	O-ring OR2056 NBR	E1525
			EA213551	O-ring 12.5x2.65, -ISO3601G	E1512
			EA213552	O-ring 13.2x2.65, -ISO3601G	E1514
			EA213554	O-ring OR3021-FPM	E1511

Cross references

The use of OEM part numbers is intended for convenience only, and does not imply that the products are of OEM origin. All Elemental Microanalysis products are guaranteed to be of high quality and are deemed to be suitable alternatives.

Cross references Micro CHNOS & CF-IRMS analysis

EuroVector Part	Description	Part No
EA213556	O-ring OR108 neoprene	E1520
EA213566	O-ring OR3106 NBR	E1521
P01-017	2x1 mm PTFE ferrule (1pcs)	E2149
P01-107	Fitting for 12 mm trap	E1581
P01-108	EA3000 12 mm empty trap assembly	E1580
P12-077	Tubing PTFE 2 x 1 mm x 2 metres	E2030-2
W08-029	O-ring OR108 neoprene	E1520
W08-031	O-ring OR2050-silicon	E1510
W08-035	O-ring OR3106 NBR	E1521
W08-036	O-ring 10.6 x 1.8-ISO3601	E1522
W08-040	O-ring OR3021-FPM	E1511
W08-041	O-ring 12.5x2.65-ISO3601G	E1512
W08-042	O-ring 17.86 x 2.62-sil	E1513
W08-043	O-ring 13.2x2.65-ISO3601G	E1514
W08-044	O-ring 18 x 2.65-ISO3601G-FKM80	E1515
W08-045	O-ring 8 x 2.65-ISO3601G-NBR	E1516
W08-052	O-ring or 15.08 x 2.62 neoprene	E1523
W08-055	Fine o-ring for holder/cap tightness Eurovector	E1524
W08-102	O-ring OR2056 NBR	E1525
W08-111	O-ring 17,13x2,62-ISO3601G	E1517

Exeter®

Exeter® Part	Description	Part No
0210-0117	Copper granules pound pack reduced 0.1 to 0.5 mm 454 g	B1084
0240-0090	Platinum weighing boat heavy, with handling tab, 9 x 4 x 2.5 mm + tab	D5004
0240-0090A	Platinum weighing boat light, with handling tab, 9 x 4 x 2.5 mm + tab	D5005
0240-0092B	Silver gauze 60 mesh 12.5 x 150 mm	B1037
0240-0113	Silver oxide/silver tungstate on chromosorb P granular 25 g	B1055
0240-0117	Copper granules reduced 0.1 to 0.5 mm 500 g	B1175
0240-0118	Tin powder fine powder sample additive 10 g	B4002
0240-0119A	Platinised carbon 10% Pt granular 0.2 to 0.85 mm 5 g	B1005
0240-0132C	Silver oxide fine powder sample additive 1 g	B4006
0240-0133	8-hydroxyquinoline OAS 1 g	B2020
0240-0137A	Filter discs glass, pk of 12	E2011
0240-0810A	Sleeve ceramic 7 x 40 mm, pk of 10	D6003
0240-1092	Copper oxide fine wires 4 x 0.5 mm 50 g	B1002
0240-1117C	Silver vanadate on chromosorb A granular 20-30 mesh 10 g	B1059
0240-1118	Silica (quartz) wool very fine 5 g	B1017
0240-1120	Benzoic acid OAS 1 g	B2004
0240-1121	Acetanilide OAS 5 g	B2114
0240-1147B	Platinum gauze 225 mesh 12 x 150 mm	D7006
0240-1217	Scrubber tube 240ABC/CEC240/440 pack of 4	C2004
0240-1217B	Scrubber tube large diameter CEC240/440	C6026
0240-1226	Reduction/reactor tube CHN/O 240A	C2001
0240-1230	Cobaltous oxide fine powder sample additive 10 g	B4005
0240-1238	Tungstic (VI) oxide fine powder sample additive 10 g	B4000
0240-1255	Combustion tube CHN transparent silica CEC240/440	C6000
0240-1293	O-ring nitrile rubber, pk of 2	E1015
0240-1321A	Magnetic ladle with cutout CEC240/440	C6020
0240-1321B	Magnetic ladle transparent silica 240ABC/CEC240/440	C2003
0240-1338	Benzylthiuronium chloride 1 g	B2007
0240-1343	Vanadium pentoxide fine powder sample additive 10 g	B4001
0240-1344C	Silver tungstate/magnesium oxide on chromosorb A granular 20 to 30 mesh 25 g	B1058

The use of OEM part numbers is intended for convenience only, and does not imply that the products are of OEM origin. All Elemental Microanalysis products are guaranteed to be of high quality and are deemed to be suitable alternatives.

Exeter® Part	Description	Part No
0240-1347	Cyclohexanone 2,4-dinitrophenylhydrazone 1 g	B2005
0240-1356	U-tube oxygen 240ABC/CEC240/440	C2008
0240-1369	Combustion tube sulfur CEC240/440	C6006
0240-1370	Reduction tube sulfur 240A	C2007
0240-1371	U-tube sulfur CEC240/440	C6010
0240-1372	Scrubber tube sulfur CEC240/440	C6009
0240-1573	Reduction tube CHN 240BC/CEC240/440	C2002
0240-1581	O-ring, pk of 10	E1007
0240-1582	O-ring nitrile rubber, pk of 10	E1006
0240-1583	O-ring, pk of 10	E1013
0240-1961	Reduction tube sulfur 240ABC/CEC240/440	C2012
0240-1962	Pyrolysis tube oxygen CEC240/440	C6017
0240-1963	Reactor tube oxygen 240ABC/CEC240/440	C2011
0240-2061A	Magnetic ladle for refractories CEC240/440	C6021
0990-2017	O-ring nitrile rubber, pk of 10	E1005
306-00001	Silicone grease 100 g	E2158
316-00003	O-ring nitrile rubber	E1032
316-00008	O-ring nitrile rubber	E1033
318-00009	Connector tube drive box CEC240/440	C6011
650-00001	Anthracene OAS 1 g	B2003
650-00002	Stearic acid OAS 1 g	B2031
650-00003	Cystine OAS 1 g	B2035
650-00008	'Universal' combustion additive fine powder 1 g	B4007
650-00011	Copper wires fine wires reduced 4 x 0.5 mm 100 g	B1015
650-00011-1	Copper wires fine wires reduced 4 x 0.5 mm 300 g	B1091
650-00012	Copper granules reduced 0.1 to 0.5 mm 100 g	B1013
6703-0376	Ladle curved transparent silica CEC240/440	C6024
6703-0378	Combustion tube CHN CEC240/440	C6003
6703-0406	Pyrolysis tube oxygen CEC240/440	C6019
6703-0410	Silver capsules ultra-clean pressed 6 x 4 mm pack of 96	D2027
6703-0411	Aluminium capsules pressed 5 x 3.5 mm, pk of 500	D3001
6703-0416	Silver capsules smooth wall 9 x 3.5 mm, pk of 100	D4101
6703-0418	Smooth wall tin capsules flat base 6 x 3 mm, pk of 100	D4001
6703-0499	Nickel capsules with hole in base pressed, 8 x 5 mm + 1 mm diameter hole, pk of 250	D3503
6703-0500	Aluminium squares 30 x 30 mm, pk of 100	D3081
6703-0503	Ladle straight transparent silica CEC240/440	C6022
6703-0514	Combustion tube CHN CEC240/440	C6001
6703-0565	Pyrolysis tube oxygen CEC240/440	C6018
6703-0580	Combustion tube sulfur CEC240/440	C6008
6703-0581	Combustion tube sulfur CEC240/440	C6007
6703-0584	Ladle anti-jetting, CEC240/440	C6023
6703-0585	Combustion tube CHN CEC240/440	C6002
6703-0589	Ladle small diameter CEC240/440	C6025

LECO®

LECO® Part	Description	Part No
501-001	Coal standard sulfur range 0.35% 3500ppm S	B2300
501-005	Coal standard sulfur range 1.07% 50 g	B2304
501-014	Coal standard sulfur range 1.46% 14600ppm S 50 g	B2305
501-015	Coal standard sulfur range 0.87% 50 g	B2303
501-020	Coal standard sulfur range 2.99% 29900ppm S 50 g	B2308
501-022	Coal standard sulfur range 3.41% 50 g	B2309
501-034	Calcium carbonate 12% 50 g	B2250
501-046	Sucrose OAS 25 g	B2121
501-053	Acetanilide OAS 5 g	B2114
501-059	Smooth wall tin capsules round base 18 x 5 mm, pk of 100	D4003
501-081	Glass wool borosilicate fibres 454 g	B1166

LECO® Part	Description	Part No	LECO® Part	Description	Part No
501-081	Glass wool rope borosilicate fibres 454 g	B1266	502-226	Silver vanadate reagent granular 0.85 to 1.7 mm 10 g	B1009
501-130	Coal standard sulfur range 4.25%	B2310	502-227	Tin capsules pressed standard weight 4 x 3.2 mm, pk of 500	D1000
501-170	Rare earth copper oxide granular 0.85 to 1.7 mm 50 g	B1123	502-258	Copper turnings fine long strands reduced & annealed 200 g	B1107
501-171	EMADrone magnesium perchlorate 454 g	B1161	502-273	Alfalfa organic analytical standard 30 g	B2273
501-171-HAZ	EMADrone magnesium perchlorate 454 g	B1161	502-275	Rye flour organic analytical standard 30 g	B2275
501-184	Coal standard sulfur range 5.13% 51300ppm S 50 g	B2311	502-277	Barley flour organic analytical standard 30 g	B2277
501-241	Silicone grease 100 g	E2158	502-278	Rice flour organic analytical standard 30 g	B2278
501-441	Sucrose OAS 25 g	B2121	502-283	Absorbent discs 3.5 mm, pk of 100	E2105
501-561	Soy bean meal organic analytical standard 30 g	B2271	502-293	Silver capsules pressed 4 x 3.2 mm, pk of 500	D2000
501-571	Copper capsules part round base 6 x 18 mm, pk of 100	D4100	502-293	Silver capsules pressed 4 x 3.2 mm light weight, pk of 500	D2300
501-614	Spatula	E2462	502-295	Copper turnings fine long strands reduced & annealed 200 g	B1107
501-621	Copper turnings fine long strands reduced & annealed 200 g	B1107	502-301	Tungsten trioxide powder 125 g	B1188
501-964	Coal standard sulfur range 5.83% 50 g	B2312	502-304	Copper wires fine wires reduced 4 x 0.5 mm 100 g	B1015M
501-967	Extreme pressure oil sulfur range 2% 100 ml	B2336	502-304-500	Copper wires fine wires pound pack reduced 4 x 0.5 mm 454 g	B1083M
501-968	Extreme pressure oil sulfur range 3.3% 33000ppm S 100 ml	B2337	502-308	Medium organic content soil standard OAS 30 g	B2178
501-969	Extreme pressure oil sulfur range 4.19% 41900ppm S 100 ml	B2338	502-309	Soil standard (peaty) 30 g	B2176
502-008	Smooth wall tin capsules round base 6 x 6 mm, pk of 100	D4008	502-314	Silica (quartz) wool very fine 502-177 50 g	B1102
502-023	Filling funnel borosilicate glass	C4027	502-397	Large tin foil cones standard weight, pk of 100	D9002
502-026	Residual oil standard sulfur range 1.49% 100 ml	B2370	502-397-400	Large tin foil cones standard weight pack of 400	D9003
502-028	Forceps stainless steel straight points - length 130 mm	E2017	502-433	Coal standard sulfur range 0.35% 3500ppm S 50 g	B2300
502-040	Smooth wall tin capsules round base 18 x 6 mm, pk of 100	D4007	502-434	Coal standard sulfur range 0.7% S% = 0.76% 50 g	B2302
502-040-100	Smooth wall tin capsules round base 18 x 6 mm, pk of 1000	D4015	502-435	Coal standard sulfur range 1.07% 50 g	B2304
502-049	Nitrogen catalyst pellets 50 g	B1061	502-436	Coal standard sulfur range 1.46% 14600ppm S 50 g	B2305
502-055	Orchard leaves standard 20 g	B2141	502-437	Coal standard sulfur range 2.99% 29900ppm S 50 g	B2308
502-062	Soil standard (sandy) 30 g	B2180	502-438	Coal standard sulfur range 5.13% 51300ppm S 50 g	B2311
502-071	High sulfur residual oil sulfur range 30% 100 ml	B2330	502-445-HAZ	Consumable kit 1000 analysis for Truessential (small tin foils)	X5151
502-077	Smooth wall tin capsules round base 6 x 6 mm, pk of 100	D4008	502-489	Micro porous crucible (10 pack)	E2388
502-085	Zinc sulfide standard 32.9% S 50 g	B2260	502-621-HAZ	Consumable kit 5000 analysis for Truspec (small tin foils)	X5150
502-092	Ethylenediaminetetra-acetic acid (EDTA) OAS 50 g	B2115	502-642	Phenylalanine OAS 25 g	B2148
502-167	Smooth wall tin capsules round base 20 x 8 mm, pk of 100	D4009	502-656	Copper turnings fine long strands reduced & annealed 200 g	B1107
502-174	EMASorb II A granular 20 to 30 mesh CO ₂ absorbant 500 g	B1316	502-670	Coal standard sulfur range 0.48% 4800ppm S 50 g	B2301
502-174-HAZ	EMASorb II A granular 20 to 30 mesh CO ₂ absorbant 500 g	B1316	502-671	Coal standard sulfur range 1.07% 50 g	B2304
502-176	EMASorb II B granular 8 to 20 mesh CO ₂ absorbant 500 g	B1317	502-672	Coal standard sulfur range 2.04% 50 g	B2306
502-177	Silica (quartz) wool very fine 50 g	B1102	502-673	Coal standard sulfur range 2.99% 29900ppm S 50 g	B2308
502-181	Tungsten (VI) oxide granular 60 g	B1217	502-674	Coal standard sulfur range 4.25% 50 g	B2310
502-181	Tungsten (VI) oxide granular 300 g	B1299	502-705	Copper wires fine wires reduced 4 x 0.5 mm 100 g	B1015M
502-183	Nickel capsules 11 x 5 mm, pk of 100	D3506	502-812	Ethylenediaminetetra-acetic acid (EDTA) OAS 50 g	B2115
502-183	Nickel capsules 10 x 6.5 mm, pk of 100	D3508	502-844	Copper wires fine wires reduced 4 x 0.5 mm 100 g	B1015M
502-186	Tin foil cones standard weight, pk of 100	D9001	503-527	Copper turnings fine long strands reduced & annealed 200 g	B1107
502-186-100	Tin foil cones standard weight, pk of 1000	D9010	589-305	Seal	E1132
502-186-200	Tin foil cones standard weight, pk of 100	D9001	589-551	O-ring sample drop block, 21.9 mm x 2.6 mm	E1112
502-187	Smooth wall tin capsules flat base 9 x 3.5 mm, pk of 100	D4035	601-437	Catalyst heater tube transparent silica	C4023
502-188	Aluminium oxide pellets 200 g	B1163	601-442	O-ring catalyst heater tube 14.0 mm x 2.6 mm	E1101
502-189	Copper wires fine wires reduced 4 x 0.5 mm 100 g	B1015M	601-483	Printer paper, American letter (8.5 x 11), 600 sheets	E2152
502-190	Copper oxide fine wires 4 x 0.5 mm 50 g	B1002	601-484	Printer ribbon	E2153
502-190	Copper oxide fine wires 4 x 0.5 mm 100 g	B1125	601-684	O-ring 31.4 mm x 2.6 mm	E1344
502-202	Coal standard sulfur range 0.48% 4800ppm S 50 g	B2301	601-691	Pinch valve tubing per ft	E2150
502-203	Stearic acid OAS 5 g	B2102	601-883	Seal piston FP228 328 428 528 CHN1000/CNS 1000	E2238
502-204	3,5-dinitrobenzoic acid OAS 5 g	B2118	601-963	Smooth wall tin capsules flat base 4 x 3.5 mm, pk of 100	D4032
502-205	Caffeine OAS 5 g	B2104	601-981	Cleaning brush	E2154
502-206	Silver capsules pressed 4 x 3.2 mm, pk of 500	D2000	603-493	O-ring	E2390
502-206	Silver capsules pressed 4 x 3.2 mm light weight, pk of 500	D2300	604-378	Forceps stainless steel curved points - length 130 mm	E2016
502-207	Cystine OAS 5 g	B2105	604-541	Oxygen lance transparent silica	C4033
502-208	Sulfanilamide OAS 1 g	B2036	605-828	O-ring combustion/catalyst/filter tube 6.0 mm x 2.6 mm	E1105
502-209	Sulfamethazine OAS 5 g	B2106	605-830	O-ring catalyst/reaction tube	E1126
502-213	Snoop leak detection fluid 236 ml/8 fluid oz	E2039	605-875	Combustion tube transparent silica	C4002
502-225	Silver tungstate on magnesium oxide granular 100 g	B1036	605-875	Combustion tube, bulk pack of C4002, pk of 5	C4003
			606-121	Sample drop plate stainless steel FP28/428	E2230
			608-089	O-ring	E2387
			608-130	Inner pyrolysis tube	C7000
			608-379	Silica (quartz) wool strips	B1192

Cross references

The use of OEM part numbers is intended for convenience only, and does not imply that the products are of OEM origin. All Elemental Microanalysis products are guaranteed to be of high quality and are deemed to be suitable alternatives.

Cross references Micro CHNOS & CF-IRMS analysis

LECO® Part	Description	Part No
614-961	Porous crucible (pack of 10)	C4065
614-961-110	Porous crucible (pack of 10)	C4065
616-138	O-ring combustion tube 36.1 mm x 3.5 mm	E1140
616-146	Oxygen lance long (lance length 5.25")	C4051
616-147	Lance assembly complete	E2199
617-136	O-ring, 5.2 mm x 2.6 mm	E1345
617-548	Reagent tube	C4332
619-065	Combustion tube	C4338
619-154	Reduction tube	C4339
619-268	Reagent tube	C4341
619-425	Glass tube truspec	C4345
619-774	Lance truspec CHNS micro	C4366
619-776	Reagent tube	C4364
619-777	Directing middle tube truspec CHNS	C4358
625-511-154	Porous crucibles (small) (pack of 5)	C4073
633-101-460	Particle filter	E2151
633-103-225	Reagent tube	C4332
702-557	O-ring 29.8 mm x 2.6 mm	E1360
760-224	O-ring lance tube	E1127
763-265	Glass wool borosilicate fibres 227g	B1167
763-265	Glass wool rope borosilicate fibres 227g	B1267
765-976	O-ring filter tube 15.5 mm x 3.5 mm	E1133
767-757	Coal standard sulfur range 2.04% 50 g	B2306
767-758	Coal standard sulfur range 2.63% 26300ppm S 50 g	B2307
767-759	Coke standard sulfur range 1.21% 12100ppm S 50 g	B2316
768-980	Particle filter	E2151
769-310	O-ring	E2389
771-030	Bubble/filter/reagent tube borosilicate glass	C4032
771-040	O-ring sample drop block 4.5 mm x 1.8 mm	E1114
771-407	O-ring 17.1 mm x 2.6 mm	E1311
772-269	O-ring doser valve assembly, pk of 10, 2.9 mm x 1.8 mm	E1109
772-520	O-ring 6.0 mm x 2.6 mm	E1110
772-910	O-ring sample drop block 18.7 mm x 2.6 mm	E1100
773-913	O-ring sample drop block 4.5 mm x 1.8 mm	E1114
774-283	O-ring sample drop block	E1129
774-425	O-ring 41.0 mm x 2.6 mm	E1342
774-613	O-ring sample drop block piston	E1130
774-638	Reagent tube 6"	C4337
775-306	Secondary (screen) filter	E2235
775-601	Reagent tube borosilicate glass	C4004
775-880	Reagent/filter tube borosilicate glass	C4005
776-279	Catalyst heater tube transparent silica	C4006
778-114	O-ring catalyst heater tube 10.8 mm x 2.6 mm	E1131
780-831	O-ring lance assembly, pk of 2, 17.2 mm x 1.8 mm	E1139
782-079-110	Ceramic stop high flow	C4061
783-275	Lance holder block	E2197
783-276	Lance holder cover	E2198

NC Technologies (Costech)

NC Technologies (Costech) Part	Description	Part No
011001	Chromium oxide granular 0.85 to 1.7 mm 50 g	B1179
011002	Cobaltous/ic oxide granular 0.85 to 1.7 mm 25 g	B1001
011003	Copper oxide fine wires 4 x 0.5 mm 50 g	B1002
011005	Copper wires for S analysis high purity reduced, 4 x 0.5 mm 40 g	B1035

The use of OEM part numbers is intended for convenience only, and does not imply that the products are of OEM origin. All Elemental Microanalysis products are guaranteed to be of high quality and are deemed to be suitable alternatives.

NC Technologies (Costech) Part	Description	Part No
011007	Cobaltous(ic) oxide silvered granular 0.85 to 1.7 mm 25 g	B1000
011008	Tungstic oxide granular 0.85 to 1.7 mm 25 g	B1025
011009	Tungstic oxide on alumina granular 0.85 to 1.7 mm 25 g	B1031
011012	Copper wires coarse wires reduced 6 x 0.65 mm 100 g	B1016
011014	Copper wires coarse wires reduced 6 x 0.65 mm 100 g	B1016
011016	Chromium oxide on alumina granular 0.85 to 1.7 mm 50 g	B1131
011017	Copper wires for S analysis high purity reduced 4 x 0.5 mm 100 g	B1177
011039	Niobium pentoxide sample additive 0.2 - 0.5 mm 25 g	B1290
011042	Copper wires fine wires 3x100 pack reduced 4 x 0.5 mm 300 g	B1091
013010	Cobaltous oxide fine powder sample additive 10 g	B4005
013040	Silver oxide fine powder sample additive 1 g	B4006
021022	Magnesium perchlorate granular 0.7 to 1.2 mm, H ₂ O absorbant 100 g	B1101
021024	Nickel wool fine wire 2 g	B1007
021025	Silica (quartz) chips granular 0.85 to 1.7 mm 100 g	B1271
021026	Silica (quartz) wool very fine 5 g	B1017
021028	Chromosorb W 30-60 mesh acid washed 10 g	B3015
021030	Soda lime granular 1 to 2.5 mm self-indicating CO ₂ absorbant 100 g	B1211
021035	Silica (quartz) wool very fine 10 g	B1208
021036	Silica (quartz) wool very fine 10 g	B1208
031040	Acetanilide OAS 1 g	B2000
031042	Atropine OAS 1 g	B2002
031043	Benzoic acid OAS 1 g	B2004
031044	Cyclohexanone 2,4-dinitrophenylhydrazine 1 g	B2005
031046	Sulfanilamide OAS 1 g	B2036
041060	Tin capsules pressed standard weight 5 x 3.5 mm, pk of 100	D1003
041061	Tin capsules pressed standard weight 8 x 5 mm, pk of 100	D1009
041062	Smooth wall tin capsules flat base 6 x 3 mm, pk of 100	D4001
041063	Smooth wall tin capsules flat base 5 x 2 mm, pk of 100	D4042
041064	Smooth wall tin capsules 1.06 x 5.5 mm (capillary), pk of 50	D4107
041065	Smooth wall tin capsules flat base 9 x 3.5 mm, pk of 100	D4035
041066	Silver capsules pressed 5 x 3.5 mm, pk of 100	D2003
041066	Silver capsules pressed 5 x 3.5 mm light weight, pk of 100	D2303
041067	Silver capsules pressed 8 x 5 mm, pk of 100	D2009
041067	Silver capsules pressed 8 x 5 mm light weight, pk of 100	D2309
041068S	Silver weighing pans/capsules pressed 10 x 10 mm, pk of 100	D5076
041070	Tin capsules pressed standard weight 6 x 4 mm, pk of 500	D1006
041072	Silver capsules pressed 6 x 4 mm light weight, pk of 100	D2307
041073	Tin weighing pans/capsules pressed standard weight, 10 x 10 mm, pk of 100	D5055
041074	Tin capsules pressed standard weight 5 x 3.5 mm, pk of 500	D1002
041077	Tin capsules pressed standard weight 8 x 5 mm, pk of 250	D1008
041077	Tin capsules pressed standard weight 9 x 5 mm, pk of 250	D1021
041080	Tin capsules pressed standard weight 6 x 4 mm, pk of 100	D1007
041081	Silver capsules pressed 6 x 4 mm, pk of 100	D2007
051080	Separation column CHNS NCS 2 m stainless steel	E3003
051081	Separation column CHN 2 m stainless steel	E3000
051082	Separation column NC/NCS 3 m stainless steel	E3004
051083	Separation column sulfur 0.8 m PTFE	E3002
051084	Separation column oxygen 1 m stainless steel	E3001
051085	Separation column NC 4 m stainless steel	E3008
051088	Separation column oxygen 2 m stainless steel	E3016
061104	Reaction tube,	C1022
061106	Seal chamfered square profile, pk of 5	E1041
061110	Prepacked tube NCS/S costech,	X1224
061112	Prepacked reaction tube CHN/CN/NCostech,	X1220
061118	Sleeve insert open both ends, 13 mm OD x 220 mm, pk of 5	C1098
064003	Quartz insert open both ends 15 mm OD x 240 mm, pk of 5	C1145
071121	Scrubber tube carbon dioxide threaded borosilicate glass	C1014
071122	O-ring schott type silicone/PTFE, pk of 2	E1023

NC Technologies (Costech) Part	Description	Part No
071123	Cap kit for threaded joints, caps, PTFE backed silicone seals, pk of 2	C1020
071124	Large trap for H ₂ O absorption	C1134
071125	O-ring Schott-type silicone/PTFE, pk of 10	E1021
080001	Tubing nuts 2 mm, pk of 10	F4523
080002	Aluminium ferrule 2 mm, pk of 10	F4506
080003	Sealing device for liquids	F5109
080005	Spatula	F5103
080005L	Spatula (left-handed)	F5104
080006	Forceps stainless steel curved points - length 130 mm	E2016
080011	Tubing stainless steel 2 x 1 mm x 3 metres	E2033
080012	Blue flexible tubing polyurethane 5x3 mm 3 m	E4404
080013	Blanking nut brass, pk of 1	E2050
080013	Blanking nut brass, pk of 10	E2216
080016	Multiwell plate 96 cell flat bottom	E2044
080017	Tubing connector 2 mm 2 mm	E2094
091107	Column fitting 6 to 2 mm stainless steel	E2035
11004	Copper wires coarse wires reduced 6 x 0.65 mm 50 g	B1046
11013	Copper wires coarse wires 3x100 g pack, reduced 6 x 0.65 mm 300 g	B1213
11014	Copper wires fine wires reduced 4 x 0.5 mm 100 g	B1015M
11022	Copper wires fine wires reduced 4 x 0.5 mm 100 g	B1015
11023	Copper oxide fine wires 4 x 0.5 mm 100 g	B1125
11029	Copper wires coarse wires 3x100 g pack reduced, 6 x 0.65 mm 300 g	B1213
11034	Copper oxide wires fine wires 4 x 0.5 mm 250 g	B1122
13001	Nickel oxide with chromium oxide granular 0.85-1.7 mm 25 g	B1033
13002	Silver vanadate reagent granular 0.85 to 1.7 mm 10 g	B1009
13003	Silver tungstate on magnesium oxide granular 100 g	B1036
13006	Silver gauze 60 mesh 12.5 x 150 mm	B1037
13009	Tungsten (VI) oxide powder fine powder 11.02-0017 25 g	B4013
21023	Molecular sieve 3A 1/16 pellets 100 g	B1047
21027	Vanadium pentoxide fine powder sample additive 10 g	B4001
21028	Chromosorb W 30-60 mesh acid washed 25 g	B3017
21032	Silver wool very fine wire unreel 89 sqcm/g 2 g 1117430	B1261
21037	Soda lime granular 1 to 2.5 mm self-indicating CO ₂ absorbant 200 g	B1189
31047	Methionine OAS 1 g	B2045
31048	2,5-bis(5-tert-butyl-2-benzo-oxazol-2-yl) thiophene (BBOT) OAS 1 g	B2044
41068	Tin weighing pans/capsules pressed standard weight, 10 x 10 mm, pk of 100	D5055
41071	Tin foil cones standard weight 502-186, pk of 100	D9001
41072	Silver capsules pressed 6 x 4 mm, pk of 500	D2006
41075	Silver capsules smooth wall 5x2 mm, pk of 250	D4103
41075	Smooth wall silver capsules 5 x 2 mm, pk of 50	D4106
41076	Silver capsules smooth wall 5.5 x 3.5 mm, pk of 250	D4102
41078	Silver capsules smooth wall 9 x 3.5 mm, pk of 100	D4101
41079	Smooth wall tin capsules flat base 5 x 2 mm, pk of 50	D4004
41080	Tin capsules pressed standard weight 10.5 x 9 mm, pk of 100	D1104
41082	Silver capsules pressed 4 x 3.2 mm, pk of 500	D2000
41082	Silver capsules pressed 4 x 3.2 mm light weight, pk of 500	D2300
43.13.011	Kit 1000 CHNS analyses costech	X3212
51082	Separation column NC/NCS 3 m stainless steel	E3004
61103	O-ring, pk of 10	E1000
61107	Reaction tube	C1002
61121	Reaction tube heavy wall	C1078

The use of OEM part numbers is intended for convenience only, and does not imply that the products are of OEM origin. All Elemental Microanalysis products are guaranteed to be of high quality and are deemed to be suitable alternatives.

NC Technologies (Costech) Part	Description	Part No
61134	Prepacked reactor 25 mm tube for c determination	X1301
61140	O-ring nitrile rubber, pk of 10	E1003
63001	Combustion tube for CHN, 2400 series	C2015
63002	Combustion tube for CHNS/N, 2400/2410 series	C2024
63003	Reduction tube for CHN, 2400 series	C2016
63004	Scrubber tube, 2400 series	C2021
64002	Reduction tube	C1030
71120	Scrubber tube water threaded borosilicate glass	C1008
71125	Silicone o-ring 12x6 diameter, pk of 2	E1024
71126	Scrubber tube carbon dioxide threaded borosilicate glass	C1014
80009	Bi-pneumatic valve diaphragm	E1011
80026	Aluminium ferrules 1.6 mm (1/16), pk of 10	F4540
91101	Slider autosampler AS50IS NA1500	F2223
99005	Cooling fan 120 mm 240V AC 18w	F2401
99015	Solenoid valve 4w	F2176

PerkinElmer®

PerkinElmer® Part	Description	Part No
0009-0709	Aluminium capsules smooth wall, flat base 7 x 2.7 mm, pk of 250	D4111
0240-0090	Platinum weighing boat light with handling tab, 9 x 4 x 2.5 mm + tab	D5005
0240-0113	Silver oxide/silver tungstate on chromosorb P granular 25 g	B1055
0240-0117	Copper granules pound pack reduced 0.1 to 0.5 mm 454 g	B1084
0240-0118	Tin powder fine powder sample additive 10 g	B4002
0240-0119	Platinised carbon 10% Pt granular 0.2 to 0.85 mm 5 g	B1005
0240-0132	Silver oxide fine powder sample additive 1 g	B4006
0240-0137	Filter discs glass, pk of 12	E2011
0240-0815	Thermolite 100 g	B4015
0240-1092	Copper oxide wires fine wires 4 x 0.5 mm 250 g	B1122
0240-1117	Silver vanadate reagent granular 0.85 to 1.7 mm 10 g	B1009
0240-1118	Silica (quartz) wool very fine 50 g	B1102
0240-1119	EMADrone magnesium perchlorate 454 g	B1161
0240-1120	Benzoic acid OAS 5 g	B2047
0240-1121	Acetanilide OAS 1 g	B2000
0240-1217	Scrubber tube, 240ABC/CEC240/440 pack of 4	C2004
0240-1225	Combustion tube CHN, 240ABC	C2000
0240-1226	Reduction/reactor tube CHN/o, 240A	C2001
0240-1230	Cobaltous oxide fine powder sample additive 10 g	B4005
0240-1238	Tungstic (VI) oxide fine powder sample additive 10 g	B4000
0240-1293	O-ring nitrile rubber, pk of 2	E1015
0240-1321	Magnetic ladle, 240ABC/CEC240/440	C2003
0240-1338	Benzylthiuronium chloride 1 g	B2007
0240-1343	Vanadium pentoxide fine powder sample additive 10 g	B4001
0240-1344	Silver tungstate on magnesium oxide granular 100 g	B1036
0240-1347	Cyclohexanone 2,4-dinitrophenylhydrazone 1 g	B2005
0240-1356	U tube oxygen, 240ABC/CEC240/440	C2008
0240-1359	Pyrolysis tube oxygen, 240A	C2005
0240-1362	Copper wires fine wires pound pack, reduced 4 x 0.5 mm 454 g	B1083
0240-1362	Copper plus - wire form 567g	B1249
0240-1369	Combustion tube sulfur, 240ABC	C2006
0240-1370	Reduction tube sulfur, 240A	C2007
0240-1371	U tube sulfur, 240ABC	C2010
0240-1372	Scrubber tube sulfur, 240ABC	C2009
0240-1573	Reduction tube CHN, 240BC/CEC240/440	C2002
0240-1581	O-ring, pk of 10	E1007
0240-1582	O-ring nitrile rubber, pk of 10	E1006
0240-1583	O-ring, pk of 10	E1013

Cross references Micro CHNOS & CF-IRMS analysis

PerkinElmer® Part	Description	Part No
0240-1673	Combustion tube autosampler, 240ABC	C2013
0240-1724	Ladle autosampler, 240ABC	C2023
0240-1961	Reduction tube sulfur, 240ABC/CEC240/440	C2012
0240-1962	Pyrolysis tube oxygen, 240BC	C2017
0240-1963	Reactor tube oxygen, 240ABC/CEC240/440	C2011
0240-2133	O-ring	E1019
0990-2017	O-ring nitrile rubber, pk of 10	E1005
0990-2048	O-ring nitrile rubber	E1010
0990-2123	O-ring nitrile rubber, pk of 2	E1014
0990-2188	O-ring silicone rubber, pk of 10	E1009
N241-0092	Nickel oxide with chromium oxide granular 0.85–1.7 mm 50 g	B1260
N241-0145	Silver gauze 60 mesh 12.5 x 150 mm	B1037
N241-0153	Combustion tube for CHN, 2400/2410 series, pk of 5	C2038
N241-0154	Reduction tube for CHN, 2400 series, pk of 5	C2039
N241-0155	Tin capsules pressed standard weight 8 x 5 mm, pk of 250	D1008
N241-0155	Tin capsules ultra-clean pressed standard weight, 8 x 5 mm bulk pack 10 x 96	D1113
N241-0164	Silver vanadate reagent granular 0.85 to 1.7 mm 100 g	B1142
N241-0165	Silver tungstate on magnesium oxide granular 500 g	B1145
N241-0166	Nickel oxide with chromium oxide granular 0.85–1.7 mm 100 g	B1146
N241-0166	Nickel oxide with chromium oxide granular 0.85–1.7 mm 500 g	B1147
N241-0168	Zirconia cloth	E2051
N241-0212	Combustion tube for CHN, 2400/2410 series, pk of 5	C2038
N2410237	Filter discs 25 mm, pk of 12	E2019
N241-0244	Tin foil discs standard weight 30 mm diameter, pk of 100	D1066
N241-0278	Tungstic oxide granular 0.85 to 1.7 mm 25 g	B1025
N241-0278	Tungstic oxide granular 0.85 to 1.7 mm 100 g	B1152
N241-0324	Cystine OAS 5 g	B2105
N241-0330	Combustion tube for CHNS/N, 2400 series, pk of 5	C2028
N241-0331	Tungstic oxide/zirconium oxide granular 0.85–1.7 mm 500 g	B1230
N241-0370	Chromium oxide granular 0.85 to 1.7 mm 100 g	B1099
N241-0501	Sulfamic acid OAS 1 g	B2017
N241-0506	CHN complete kit for 2000 runs PE 2400	X2013
N241-0512	Consumable kit CHNS PE2400	X2010
N2410680	Consumable kit CHN combustion for 2000 analysis	X2015
N2410681	Consumable kit CHN reduction for 500 analysis	X2014
N2410682	Consumable kit CHNS PE2400	X2016
N2410683	Consumable kit CHN PerkinElmer for 2000 analysis	X2012
N2410684	Consumable kit CHNS PerkinElmer for 2000 analysis	X2011
N241-0690	Silver tungstate on magnesium oxide granular 25 g	B1038
N241-0691	Copper oxide fine wires 4 x 0.5 mm 50 g	B1002
N2410692	EA-6000 210 g	B1227
N241-0692	Tungstic oxide granular 0.85 to 1.7 mm 25 g	B1025
N241-0692	Tungstic oxide granular 0.85 to 1.7 mm 100 g	B1152
N2410693	Prepacked reaction tube 2400 CHNS	X2002
N2410694	Prepacked reduction tube 2400 CHN	X2001
N2410695	Prepacked combustion tube 2400 CHN	X2000
N2410696	Prepacked oxygen pyrolysis tube 2400	X2003
N2410698	PerkinElmer 2400 oxygen reduction furnace tube	X2005
N241-1235	Pyrolysis tube, 2400 series	C2018
N241-1255	Tin capsules pressed standard weight 8 x 5 mm, pk of 250	D1008
N241-1255	Tin capsules pressed standard weight 8 x 5 mm, pk of 100	D1009
N241-1255	Tin capsules ultra-clean pressed std weight, 8 x 5 mm pk of 96	D1029
N241-1264	Combustion tube for CHN, 2400 series	C2015
N241-1273	Platinum gauze 225 mesh 12 x 150 mm	D7006
N241-1274	Retrieving wire	E2101
N241-1291	Reduction tube for CHN, 2400 series	C2016

The use of OEM part numbers is intended for convenience only, and does not imply that the products are of OEM origin. All Elemental Microanalysis products are guaranteed to be of high quality and are deemed to be suitable alternatives.

PerkinElmer® Part	Description	Part No
N241-1300	Link tube, 2400 series	C2019
N241-1333	Reduction tube plug with flange copper, 2400 series	D6002
N241-1335	Vial receptacle nickel 2400 series	D6000
N241-1359	Scrubber tube, 2400 series	C2021
N241-1362	Tin capsules pressed standard weight 14 x 6 mm, pk of 200	D1017
N241-1363	Tin foil discs standard weight 30 mm diameter, pk of 100	D1066
N241-1364	Silver capsules pressed 6 x 4 mm, pk of 500	D2006
N241-1364	Silver capsules pressed 6 x 4 mm, pk of 100	D2007
N241-1364	Silver capsules ultra-clean pressed 6 x 4 mm pk of 96	D2027
N241-1401	Slitted sleeve, 2400 series	C2025
N241-1514	Combustion tube for CHNS/N, 2400/2410 series	C2024
N241-1527	Copper granules pound pack reduced 0.3 to 0.85 mm 454 g	B1138

Picarro®

Picarro® Part	Description	Part No
C0201	Reaction tube Picarro CM model 02	C1200
C0202	Chromium oxide granular 0.85 to 1.7 mm 50 g	B1179
C0203	Cobaltous(ic) oxide silvered granular 0.85 to 1.7 mm 25 g	B1000
C0204	Copper wires fine wires reduced 4 x 0.5 mm 100 g	B1015
C0205	Magnesium perchlorate granular 0.7 to 1.2 mm, H ₂ O absorbant 100 g	B1101
C0206	Silica (quartz) wool very fine 10 g	B1208
C0209	Tin capsules pressed standard weight 9 x 5 mm, pk of 250	D1021

Sercon

Sercon Part	Description	Part No
SC0001	Chromium oxide granular 0.85 to 1.7 mm 25 g	B1004
SC0002	Copper wires fine wires reduced 4 x 0.5 mm 100 g	B1015
SC0003	Copper oxide fine wires 4 x 0.5 mm 100 g	B1125
SC0004	Silica (quartz) chips granular 0.85 to 1.7 mm 50 g	B1008
SC0005	Nickel sheet 130 x 130 mm x 0.13 mm for tube lining	B1024
SC0006	Silica (quartz) wool very fine 10 g	B1208
SC0007	Silver wool very fine wire unreel 89 sqcm/g 10 g	B1119
SC0008	Copper wires for S analysis high purity reduced 4 x 0.5 mm 40 g	B1035
SC0009	Tin capsules pressed standard weight 8 x 5 mm pk of 250	D1008
SC0010	Tin capsules pressed standard weight 6 x 4 mm pk of 500	D1006
SC0011	Sleeve insert open both ends transparent silica 15 x 180 mm	C1050
SC0012	Reaction tube transparent heavy wall silica	C1039
SC0018	Tin capsules pressed standard weight 12.5 x 5 mm pk of 200	D1010
SC0019	Tin capsules pressed standard weight 12 x 6 mm pk of 200	D1012
SC0020	Tin capsules pressed standard weight 20 x 8 mm pk of 100	D1011
SC0021	Tin foil discs standard weight 21 mm diameter pk of 100	D1064
SC0022	Magnesium perchlorate granular, 0.7 to 1.2 mm H ₂ O absorbant 100 g	B1101
SC0023	Magnesium perchlorate self indicating granular, 0.7 to 1.2 mm, 100 g	B1141
SC0024	Chromosorb W 30-60 mesh acid washed 10 g	B3015
SC0025	Tungstic oxide on alumina granular 0.85 to 1.7 mm 25 g	B1031
SC0027	Vanadium pentoxide fine powder sample additive 10 g	B4001
SC0032	Copper gasket 64 mm pk of 5	E2780
SC0033	Copper gasket 38 mm pk of 5	E2781
SC0034	Tungstic oxide/zirconium oxide granular 0.85 to 1.7 mm 50 g	B1082
SC0036	Silver capsules pressed 6 x 4 mm light weight pk of 100	D2307
SC0036	Silver capsules pressed 6 x 4 mm pk of 100	D2007
SC0039	Glassy carbon chips 2-3 mm 100 g	C7006
SC0040	Scrubbing tube borosilicate	C1063
SC0046	O-ring	E1421

Sercon Part	Description	Part No	Sercon Part	Description	Part No
SC0047	O-ring	E1420	SC1079	Silver capsules pressed 4 x 3.2 mm pk of 500	D2000
SC0047	O-ring pk of 10	E1420-10	SC1080	Silver capsules pressed 4 x 3.2 mm light weight pk	D2301
SC0084	Scrubbing tube, water, threaded, borosilicate glass	C1008	SC1080	Silver capsules pressed 4 x 3.2 mm pk of 100	D2001
SC0085	Cap kit for threaded joints caps, PTFE backed silicone seals pk of 2	C1020	SC1081	Silver capsules pressed 5 x 3.5 mm pk of 500	D2002
SC0151	Nickel wool, fine wire, 2g	B1007	SC1081	Silver capsules pressed 5 x 3.5 mm light weight pk of 500	D2302
SC0157	Copper wires fine wires reduced 4 x 0.5 mm 50 g	B1014	SC1083	Silver capsules pressed 6 x 4 mm light weight pk of 500	D2306
SC0162	Magnesium perchlorate granular 0.7 to 1.2 mm, H ₂ O absorbant 25 g	B1019	SC1083	Silver capsules pressed 6 x 4 mm pk of 500	D2006
SC0172	Platinised copper oxide 10% Pt isotope grade, granular 0.2 to 0.5 mm 2 g	B1030	SC1084	Silver capsules pressed 8 x 5 mm light weight pk of 250	D2308
SC0189	Platinised copper oxide 20% Pt isotope grade, granular 0.2 to 0.5 mm 2 g	B1050	SC1084	Silver capsules pressed 8 x 5 mm pk of 250	D2008
SC0203	Magnesium perchlorate granular 0.7 to 1.2 mm, H ₂ O absorbant 500 g	B1081	SC1085	Silver capsules pressed 8 x 5 mm light weight pk of 100	D2309
SC0204	Tungstic oxide/zirconium oxide granular 0.85 to 1.7 mm 50 g	B1082	SC1085	Silver capsules pressed 8 x 5 mm pk of 100	D2009
SC0326	EMASorb IIA granular 20 to 30 mesh, CO ₂ absorbant 25 g	B1320	SC1086	Silver capsules pressed 12.5 x 5 mm light weight pk of 100	D2310
SC0288	Nickelised carbon 50% Ni, granular 0.85 to 1.7 mm 5 g	B1182	SC1086	Silver capsules pressed 12.5 x 5 mm pk of 200	D2010
SC0327	Nickel carbon wool 5 g	B1242	SC1087	Silver capsules pressed 12 x 6 mm pk of 200	D2012
SC0330	Quartz wool discs 16 mm diameter - pk of 25	B1251	SC1088	Silver capsules ultra-clean pressed 6 x 4 mm pk of 96	D2027
SC0336	Silica (quartz) chips granular 0.85 to 1.7 mm 100 g	B1271	SC1094	Silver discs 16 mm diameter pk of 100	D2063
SC0381	Acetanilide OAS 1 g	B2000	SC1123	Aluminium capsules ultra-clean pressed 8 x 5 mm pk of 96	D3029
SC0383	Atropine OAS 1 g	B2002	SC1153	Smooth wall tin capsules flat base 5.5 x 2 mm pk of 100	D4000
SC0385	Benzoic acid OAS 1 g	B2004	SC1154	Smooth wall tin capsules flat base 6 x 3 mm pk of 100	D4001
SC0386	Cyclohexanone 2,4-dinitrophenylhydrazone 1 g	B2005	SC1171	Smooth wall tin capsules flat base 5.5 x 3.5 mm pk of 100	D4033
SC0387	Atropine OAS 10 g	B2006	SC1392	O-ring pk of 10	E1001
SC0388	Benzylthiuronium chloride 1 g	B2007	SC1421	Seal chamfered square profile pk of 5	E1042
SC0410	Sulfanilamide OAS 1 g	B2036	SC1596	Spatula stainless steel 150 x 3 mm	E2000
SC0413	Diphenyl OAS 1 g	B2039	SC1605	Forceps stainless steel curved points - length 130 mm	E2016
SC0414	Imidazole OAS 1 g	B2040	SC1606	Forceps stainless steel straight points - length 130 mm	E2017
SC0415	Isatin OAS 1 g	B2041	SC1625	Snoop leak detection fluid 236 ml/8 fluid oz	E2039
SC0418	2,5-bis(5-tert-butyl-2-benzo-oxazol-2-yl)thiophene, (BBOT) OAS 1 g	B2044	SC1630	Multiwell plate 96 cell flat bottom	E2044
SC0419	Methionine OAS 1 g	B2045	SC1722	Silicone grease 150 g	E2158
SC0420	2,5-bis(5-tert-butyl-2-benzo-oxazol-2-yl)thiophene, (BBOT) OAS 5 g	B2046	SC1925	Copper gasket 64 mm pk of 5	E2780
SC0421	Benzoic acid OAS 5 g	B2047	SC1926	Copper gasket 38 mm pk of 5	E2781
SC0430	Benzylthiuronium chloride OAS 5 g	B2108	SC2010	Separation column oxygen 1 m	E3030
SC0436	Acetanilide OAS 5 g	B2114	SC2011	Separation column NC 0.5 m stainless steel	E3031
SC0459	High organic content sediment IRMS standard OAS/isotope 5 g	B2151	SC2012	Separation column sulfur 0.6 m stainless steel	E3032
SC0461	Low organic content soil IRMS standard OAS/isotope 5 g	B2153	SC2013	Separation column NC 0.5 m stainless steel	E3033
SC0463	Protein IRMS standard OAS/isotope 5 g	B2155	SC2147	Prepacked reaction tube includes C1050 quartz liner	X1200
SC0465	Wheat flour IRMS standard OAS/isotope 5 g	B2157	SC2149	Prepacked reaction tube transparent heavy wall, includes C1050 quartz liner	X1201
SC0467	Sorghum flour IRMS standard OAS/isotope 5 g	B2159	SC2150	Prepacked reduction tube	X1202
SC0474	Olive oil isotopic working IRMS standard for ¹³ C 5 g	B2172	SC2151	Prepacked reduction tube	X1203
SC0475	Urea isotopic working IRMS standard for ¹³ C, ¹⁵ N, 5 g,	B2174	SC2152	Prepacked reduction tube transparent heavy wall	X1204
SC0610	Chromosorb W 30-60 mesh acid washed 25 g	B3017	SC2153	Prepacked reaction/reduction tube transparent sulfur	X1205
SC0650	Reaction tube transparent silica	C1040	SC2155	Prepacked oxygen pyrolysis tube transparent silica	X1207
SC0687	Sleeve insert open both ends transparent silica 15 x 220 mm	C1094	SC2157	Packed hydrogen pyrolysis tube transparent silica	X1209
SC0694	Ceramic tube	C1103	SC2258	Wheat flour IRMS standard OAS/isotope 5 g	B2157
SC0973	Glassy carbon chips 2-3 mm, 25 g	C7003	SC2264	Silicone grease 150 g	E2158
SC0974	Glassy carbon tube	C7004	SC2332	Ceramic tube with molybdenum foil liner, 19 mm OD x 470 mm for HT-EA	X7022
SC1012	Tin capsules pressed ultra-light weight 6 x 4 mm pk of 100	D1016	SC2334	² H and ¹⁸ O isotope IRMS standard medium enriched water, 25 ml	B2191
SC1023	Tin capsules ultra-clean pressed ultra-light weight, 6 x 4 mm pk of 100	D1035	SC2335	² H and ¹⁸ O isotope IRMS standard zero natural water, 25 ml	B2192
SC1027	Tin foil discs standard weight 11 mm diameter pk of 100	D1060	SC2336	² H and ¹⁸ O isotope IRMS standard medium natural water, 25 ml	B2193
SC1030	Tin foil discs standard weight 16 mm diameter pk of 100	D1063	SC2337	² H and ¹⁸ O isotope IRMS standard low natural water, 25 ml	B2194
SC1079	Silver capsules pressed 4 x 3.2 mm light weight pk of 500	D2300	SC2346	Silica (quartz) wool very fine 15 g	B1276
			SC2361	Chromosorb W 30-60 mesh acid washed 50 g	B3019
			SC2396	Silver capsules pressed ultra clean, 12 x 6 mm pk of 200	D2013
			SC2418	O-ring	E1420
			SC2418	O-ring pk of 10	E1420-10
			SC2419	O-ring	E1421
			SC2447	Spatula (left handed)	F5104
			SC2448	Sealing device for liquids	F5109
			SC2461	Separation column, sulfur	E3034
			SC2462	² H and ¹⁸ O isotope standard set of 5 water working standards	B2195
			SC2495	GL14 scrubber straight 220 mm	C1142

The use of OEM part numbers is intended for convenience only, and does not imply that the products are of OEM origin. All Elemental Microanalysis products are guaranteed to be of high quality and are deemed to be suitable alternatives.

Cross references Micro CHNOS & CF-IRMS analysis

Thermo Fisher Scientific®

Thermo Fisher Scientific® Part	Description	Part No
1117391	Silver capsules pressed 4 x 3.2 mm light weight, pk of 250	D2301
1117430	Silver wool very fine wire unreel 89 sqcm/g, 2 g	B1261
1118121	Prepacked reaction tube 1500/1110/1108/2500, (electrolytic wires) CHNS	X1156
1121030	GC column TC/EA 0.6 m 1/4 stainless steel	E3035
1121130	Aluminium ferrules 1.6 mm (1/16), pk of 10	F4540
1121370	Tubing nuts 2 mm, pk of 10	F4523
1142960	Kit 1000 analyses NC Flash1112	X3211
1142961	Spares & consumables FlashEA, (NC, 3000 analyses)	X1132
1144320	Tin capsules pressed standard weight 5 x 3.5 mm, pk of 100	D1003
1156890	Flash 2000 HT ceramic outer tube	C1105
1157110	Sulfur-kit FlashEA 1112 / 2000/Flash HT	X1130
1293140	Consumables FlashEA/Flash HT, (NCS, 1000 analyses)	X1131
1293150	Consumables FlashEA, (NC, 1000 analyses)	X1133
1293160	Consumables Flash HT, (NC, 1000 analyses)	X1134
1293170	Spares & consumables Flash HT, (NC, 3000 analyses)	X1135
190 03750	NCS 1000 analysis kit Flash HT / Flash HT plus / IRMS	X1114
190 03780	NC 1000 an. Kit Flash HT / HT plus	X1116
190 04220	Package A for solid sample Flash 2000	X7004
190 04225	Package B for solid sample Flash 2000	X7005
19001100	Consumables kit 1000 analyses 1106 sulfur	X1002
19001201	Consumables kit 1000 analyses 1108/II CHN & oxygen	X1004
19001202	Consumables kit 1000 analyses 1108/II CHNS & oxygen	X1006
19001203	Consumables kit 1000 analyses 1108/II CHN	X1003
19001204	Consumables kit 1000 analyses 1108/II CHNS	X1005
19001300	Consumables kit 1000 analyses 1106 oxygen	X1001
19001301	Consumables kit 1000 analyses 1108/II oxygen	X1007
19002400	Consumables kit 1000 analyses 1500/II nitrogen	X1008
19002401	Consumables kit 1000 analyses 1500/II NC	X1009
19002402	Consumables kit 1000 analyses 1500/II NCS	X1010
19002410	Consumables kit 1000 analysis FlashEA1112 CHN	X1080
19002411	Consumables kit 1000 analyses FlashEA1112, CHNS/NCS/S with empty tubes	X1081
19002412	Consumables kit 1000 analyses EA1112, CHNS/NCS/S with Prepacked tubes	X1082
19002414	Consumable kit 1000 analyses NC Flash 2000	X1091
19002415	Consumable kit 1000 analyses NC soil/sed/fil Flash 2000	X1085
19002416	Consumables kit 1000 analysis Flash EA1112 oxygen	X1083
19002418	Kit for 1000 analyses NC/IRMS	X1084
19002430	Consumable kit 1000 analyses N-lubricant	X1105
19002560	Consumable kit 1000 analysis kit Flashsmart N/protein	X7070
19002561	Consumable kit 1000 analysis kit Flashsmart NC soil	X7071
19002562	Consumable kit 1000 analysis kit Flashsmart CHN	X7072
19002563	Consumable kit 1000 analysis kit Flashsmart oxygen	X7075
19002564	Consumable kit 1000 analysis kit Flashsmart, CHNS/NCS/S (no prepack)	X7073
19002565	Consumable kit 1000 analysis kit Flashsmart CHNS, (with prepacked tube)	X7074
19002566	Consumable kit 1000 analysis kit Flashsmart N org	X7076
19002567	Consumable kit 1000 analysis kit Flashsmart NC org	X7077

The use of OEM part numbers is intended for convenience only, and does not imply that the products are of OEM origin. All Elemental Microanalysis products are guaranteed to be of high quality and are deemed to be suitable alternatives.

Thermo Fisher Scientific® Part	Description	Part No
19002568	Consumable kit 1000 analysis kit Flashsmart N lubricant	X7078
19002569	Consumable kit N/protein and N/brew determination, (for liquid samples)	X7080
19003200	Consumables kit 1000 analyses 1106 CHN	X1000
19004128	TOC (total organic carbon) kit	E5010
19004143	Consumable kit 1000 analyses kit for NA2000	X1098
19004151	Consumable kit 1000 analyses NA2000 with SS tube	X1099
19004157	Cone replacement kit AS128	F2201
19004245	Conv kit FlashEA NC to NCS det	X1093
20500500	Forceps stainless steel curved points - length 130 mm	E2016
20500505	Forceps stainless steel straight points - length 130 mm	E2017
20500521	Large spatula for NA2000	F5108
20500600	Spatula	F5103
20500600	Spatula (left handed)	F5104
20500620	Large spatula for NA2000	F5108
20500625	Cleaning tool	F5113
20500628	Tool for lower fitting ea	F5164
20501610	32a wrench	F5165
20503002	Sealing device for liquids	F5109
23103008	Scrubber tube water threaded borosilicate glass	C1008
23903100	Program timer 0-12 minutes	E2012
23903100	Delay timer 0-120 seconds	E2013
240 05405	Silver capsules pressed 8 x 5 mm, pk of 100	D2009
240 05410	Silver capsules pressed light weight 6 x 4 mm box of 1000	D2019
240 06410	Tin containers mega box light weight 8 x 5 mm set of 1000	D1019
240 14019	Complete vials 2swv (pack of 100)	E7610
240 14032	Vial solvent 4 ml st 4svq (set of 5)	E7611
24000700	Chloropentane doping vessel borosilicate glass	C1042
24005100	Silver capsules smooth wall 5x2 mm, pk of 250	D4103
24005100	Smooth wall silver capsules 5 x 2 mm, pk of 50	D4106
24005300	Tin capsules pressed standard weight 5 x 3.5 mm, pk of 100	D1003
24005400	Silver capsules pressed 6 x 4 mm light weight, pk of 100	D2307
24005411	Silver capsules pressed 6 x 4 mm, pk of 100	D2007
24006400	Tin capsules pressed ultra-light weight 8 x 5 mm, pk of 100	D1013
24007000	Smooth wall tin capsules 1.06 x 5.5 mm (capillary), pk of 50	D4107
24007200	Smooth wall tin capsules flat base 9 x 3.5 mm, pk of 100	D4035
24008810	Smooth wall tin capsules flat base 6 x 3 mm, pk of 100	D4001
24008820	Smooth wall tin capsules flat base 4.5 x 2 mm, pk of 100	D4019
24010049	Multiwell plate 12 cell flat bottom	E2065
24030000	10 CV vials, pk of 5	E7609
24070005	Vials 2.5 ml, pk of 100	E2300
24074020	Vials 10 ml, pk of 100	E2310
24806400	Thermal chart paper roll	E2067
25204400	Swarf crucible transparent silica, pk of 5	C1005
25204500	Swarf crucible transparent silica, pk of 5	C1004
25204510	Quartz liner	C1120
25204510	Quartz liner, pk of 5	C1127
25204600	Swarf crucible for C1069 C1072 C1078, pk of 5	C1016
25205000	Silica swarf crucible 13 mm OD 250 mm	C1065
25205000	Sleeve insert open both ends, 13 x 250 mm	C1123
25205000	Metal swarf crucible NA2000/2100	D6005
25205011	High performance inconel reactor crucible, 18 mm OD Flash EA1112	F5153
25208000	Tin weighing pans/capsules pressed standard weight, 10 x 10 mm, pk of 100	D5055

Thermo Fisher Scientific® Part	Description	Part No	Thermo Fisher Scientific® Part	Description	Part No
25208015	Tin foil discs standard weight 30 mm diameter, pk of 100	D1066	29050306	Seal chamfered square profile, pk of 5	E1043
25208018	Tin foil discs standard weight 35 mm, pk of 100	D1078	29050567	O-ring, pk of 10	E1000
25208019	Tin foil discs standard weight 62 mm, pk of 100	D1079	313 03218	Septa for waste bottle (set of 5)	E7613
25208021	Tin foil discs standard weight 85 mm diameter, pk of 100	D1077	313 03230	Septa for Flash 2000 injector (set of 50)	E7614
25209010	Sealing device	F5112	31302100	Bi-pneumatic valve diaphragm	E1011
26007800	Separation column sulfur 0.8 m PTFE	E3002	31303200	Septum liquid injector , pk of 50	E2360
26007801	Separation column 6 x 4 PTFE 0.15 m	E3039	31303209	Septum liquid injector , pk of 50	E2361
26007900	Separation column oxygen 1 m stainless steel	E3001	31303216	Blue silicone/PTFE septum 8-ST101, pk of 1000	E7605
26007920	Separation column SS	E3023	33406200	Nickel sheet 130 x 130 mm x 0.13 mm for tube lining	B1024
26008000	Separation column CHN 2 m stainless steel	E3006	338 22210	Quartz wool discs 15 mm diameter, pk of 25	B1250
26008200	Separation column CHN 2 m stainless steel	E3000	338 40019	Nicotinamide OAS 1 g	B2132
26008205	Separation column NC/NCS 3 m stainless steel	E3004	338 40036	Tocopherol nicotinate OAS 2 g	B2127
26008206	Separation column CHNS NCS 2 m stainless steel	E3003	33801801	Molecular sieve 3A 1/16 pellets 100 g	B1047
26008207	Separation column CHN 2 m PTFE	E3020	33821710	Copper oxide fine wires 4 x 0.5 mm 50 g	B1002
26008208	Separation column CHNS 2 m PTFE	E3013	33821720	Copper oxide wire (coarse) 100 g	B1234
26008215	Separation column CHNS 2 m PTFE	E3038	33821730	Copper oxide fine wires 4 x 0.5 mm 25 g	B1248
26008220	Separation column PTFE 2 m	E3024	33821900	Magnesium perchlorate (flakes) 25 g	B1274
26018500	Separation column trace sulfur 0.5 m PTFE	E3007	33821900	Magnesium perchlorate (flakes) 100 g	B1275
28104400	Halogens trap borosilicate glass	C1021	33822100	Copper sulfate hydrated granular for gas doping 250 g	B1114
28113064	Large adsorption trap CO ₂ without fast connectors	F5162	33822200	Silica (quartz) wool very fine 5 g	B1017
28113090	Scrubber tube carbon dioxide threaded borosilicate glass	C1014	33822205	Silica (quartz) wool very fine 15 g	B1276
28113100	Scrubbing tube kit water	E2350	33822300	Silica (quartz) chips granular 0.85 to 1.7 mm 50 g	B1008
28113102	Small trap with o-rings, threaded caps and fitting,	E6101	33822400	Cyclohexanone 2,4-dinitrophenylhydrazone 1 g	B2005
28113104	Small water adsorption filter assembly (with caps, o-rings and SS fitting) without fast connectors	E2341	33822500	Benzoic acid OAS 1 g	B2004
290 30343	Green o-ring for shaft of MAS plus autosampler (set of 3)	E6059	33822800	Cobaltous/ic oxide granular 0.85 to 1.7 mm 25 g	B1001
290 34051	Tubing ferrule for Flash aluminium, 4 mm, pk of 1	F4543	33822900	Chromium oxide granular 0.85 to 1.7 mm 25 g	B1004
290 34545	Sleeve PTFE OD 2 mm set of 10	F4541	33823400	Diphenyl OAS 1 g	B2039
29000057	Silicone grease 100 g	E2158	33823800	Nickelised carbon 30% Ni granular 0.3 to 0.85 mm 5 g	B1086
29002195	MAS200R autosampler piston o-ring, pk of 1	E6055	33824400	Atropine OAS 1 g	B2002
29003193	GI32 silicone seal for threaded scrubbers, pk of 2	E1582	33824500	Cobaltous(ic) oxide silvered granular 0.85 to 1.7 mm 25 g	B1000
29003195	Upper seal AS128 PTFE between sample tray & cone body	F6112	33824600	Tungstic oxide granular 0.85 to 1.7 mm 25 g	B1025
29003635	Silicone o-ring 12x6 diameter, pk of 2	E1024	33824700	Nickel oxide granular 0.85 to 1.7 mm 25 g	B1034
29004045	Olive, 2 mm stainless steel	E2100	33825000	Nickel wool fine wire 2 g	B1007
29005046	O-ring nitrile rubber	E1008	33825100	Sulfanilamide OAS 1 g	B2036
29010082	O-ring, pk of 2	E1059	33825300	Isatin OAS 1 g	B2041
29010386	O-ring for reactor, pk of 5	E6057	33835200	Benzylthiuronium chloride 1 g	B2007
29010684	Silicon o-ring for crucible, pk of 5	E6056	33835210	2,5-bis(5-tert-butyl-2-benzo-oxazol-2-yl) thiophene (BBOT) OAS 1 g	B2044
29013603	O-ring schott type silicone/PTFE, pk of 10	E1021	33835230	Soda lime granular 1 to 2.5 mm self-indicating CO ₂ absorbant 200 g	B1189
29013603	O-ring schott type silicone/PTFE, pk of 2	E1023	33835235	Soda lime granular 1 to 2.5 mm self-indicating CO ₂ absorbant 100 g	B1211
29013635	Silicone o-ring 12x6 diameter, pk of 2	E1024	33835240	Lubricant standard 2 g	B2145
29020640	Bottom o-ring for 18 mm OD quartz reactor, pk of 5	E6052	33835300	Copper wires coarse wires reduced 6 x 0.65 mm 100 g	B1016
29022910	Seal chamfered square profile, pk of 5	E1041	33835310	Copper wires for S analysis high purity reduced 4x0.5 mm 40 g	B1035
29030042	Seal chamfered square profile, pk of 5	E1042	33835310	Copper wires for S analysis coarse high purity, reduced 6 x 0.65 mm 40 g	B1040
29030331	O-ring, pk of 10	E1001	33835311	Electrolytic copper 90 g	B1239
29030567	O-ring, pk of 10	E1200	33835312	Copper wires coarse wires reduced 6 x 0.65 mm 50 g	B1046
29031214	O-ring window for MAS200R autosampler	E1158	33835314	Electrolytic copper 80 g	B1238
29034044	Aluminium ferrules 1.6 mm (1/16), pk of 10	F4540	33835420	Tungstic oxide on alumina granular 0.85 to 1.7 mm 25 g	B1031
29034045	Aluminium ferrule 2 mm, pk of 10	F4506	33835430	Imidazole OAS 1 g	B2040
29050301	O-ring nitrile rubber, pk of 10	E1022	33836700	Acetanilide OAS 1 g	B2000
29050304	O-ring nitrile rubber, pk of 10	E1020	33837510	Vanadium pentoxide fine powder sample additive 10 g	B4001
29050306	O-ring nitrile rubber, pk of 10	E1002	33837510	Vanadium pentoxide fine powder sample additive 1 g	B4010

The use of OEM part numbers is intended for convenience only, and does not imply that the products are of OEM origin. All Elemental Microanalysis products are guaranteed to be of high quality and are deemed to be suitable alternatives.

Cross references Micro CHNOS & CF-IRMS analysis

Thermo Fisher Scientific® Part	Description	Part No
33837530	Chromosorb W 30-60 mesh acid washed 25 g	B3017
33840000	N/protein oxidation catalyst, copper oxide/platinised alumina 40 g	B1103
33840001	Urea OAS 1 g	B2038
33840010	CHNS/CHNS-O standards kit, cystine, sulfanilamide, methionine, BBOT 4 x 0.5 g	B2135
33840011	CHN/CHN-O standards kit acetanilide, atropine, cyc, nicotinamide 4 x 0.5 g	B2136
33840013	Nitrogen standards kit methionine atropine, nicotinamide, acetanilide 4 x 0.5 g	B2133
33840018	Cystine OAS 1 g	B2035
33840025	NC soil standard 5 g	B2051
33840026	Soil standard 2 g NCS	B2050
33840030	Fluorine absorber mix 15 g	B1240
33840035	Silica gel self-indicating granular drying agent 2 to 6 mm 100 g	B1044
343 01512	Piston assembly MAS200R	F2224
34701808	Bottom adapter (kit)	F5166
34709518	Tube coupling 18 to 2 mm lower reaction	F4510
34715401	Column fitting 6 to 2 mm stainless steel	E2035
34736100	Connector brass 2 mm 4 way	E2096
34739133	Tubing coupling 2 mm stainless steel	E2095
34744100	Tubing connector 2 mm to 2 mm	E2094
35008455	End fitting adsorbtion trap connection	F5163
35034108	Tube connector push fit	E2034
35036103	Blanking cap brass	E2099
35040403	Tubing nuts 2 mm, pk of 10	F4523
35041101	Knurled retaining nut brass	E2097
35045100	Blanking nut brass, pk of 1	E2050
35045100	Blanking nut brass, pk of 10	E2216
35045400	Blanking nut stainless steel	E2036
35265000	Chart paper, Z-fold, pk of 2	E2068
35265100	Recorder pen	E2069
354 50010	Furnace core 1500/1108/1110/2000/2500 w/o thermocouple	E2138
35411200	Furnace core 1106 w/o thermocouple	F2102
35460018	Replacement furnace Flash EA with 18 mm & 25 mm adaptors	E4410
35460021	Replacement furnace Flash EA with 18 mm & 25 mm adaptors	E4410
35460022	Replacement furnace Flash EA with 18 mm & 25 mm adaptors	E4410
36500204	Syringe 100µl Hamilton 80665/00	E2362
36502019	Syringe 10µl 80 mm SGE S002124	E2365
36806040	Al seal 11 mm PTFE faced septum, pk of 100	E2301
37001101	Slider autosampler as50ls NA1500	F2223
386 06085	Screw cap 8-sc (set of 5)	E7612
38606035	Al seal 20 mm PTFE faced septum, pk of 50	E2311
38606073	Screw caps 8-sc, pk of 1000	E7606
39102500	Tubing stainless steel 2 x 1 mm x 3 metres	E2033
39103800	Reduction tube stainless steel	E2020
40320000	Thermocouple	F2153
40519015	Solenoid valve 4W	F2176
40523005	Purging valve autosampler slide type	E2102
40600300	Cooling fan 120 mm 240V AC 18W	F2401
42001500	Tubing PTFE 2 x 1 mm x 5 metres	E2030
42001501	Tubing PTFE 2 x 1 mm x 5 metres	E2030

The use of OEM part numbers is intended for convenience only, and does not imply that the products are of OEM origin. All Elemental Microanalysis products are guaranteed to be of high quality and are deemed to be suitable alternatives.

Thermo Fisher Scientific® Part	Description	Part No
42001600	Tubing PTFE 4 x 2 mm 1 m	E2211
42001601	Tubing PTFE 4 x 2 mm 5 m	E2213
42001700	PTFE tube 6 mm x 4 mm x 1 m	E2115
42010000	Flexible blue tubing polyurethane 5x3 mm 3 m	E4404
468 00650	Prepacked reduction tube using coarse copper wires	X1037
468 02009	Packed combustion/reduction tube CHN/NC/N EA1112	X1151
468 02015	Prepacked reactor CHNS/NCS/S inc crucible	X1160
468 20076	Prepacked oxidation reactor for Flash IRMS	X1170
46800650	Prepacked reduction tube 1500(2) 2500	X1048
46800900	Reaction tube transparent silica	C1000
46801000	Reduction 'U' tube transparent silica	C1003
46801600	Reaction tube transparent silica	C1002
46802005	Prepacked reaction tube 1500/1110/1108/2500, (electrolytic wires) CHNS	X1165
46802006	Packed reaction/reduction tube EA1108 EA1110 CHN, single tube system	X1034
46802007	Packed combustion / reduction tube CHNS/NCS/S, (Cu wires replaces electrolytic copper)	X1152
46802007	Flash EA1112 prepacked reaction tube using electrolytic copper CHNS/NCS/S	X1155
46820020	Reaction tube transparent silica	C1018
46820050	Reaction tube stainless steel	E2159
46820060	Reaction tube transparent silica	C1022
46820060	Reaction tube heavy wall transparent silica	C1078
46820065	Reaction tube transparent silica Flash 1112	C1069
46820070	Reaction tube transparent silica Flash 1112	C1069
46820075	High performance alloy reactor Flash EA1112	F5150
46820077	Prepacked reduction reactor for Flash IRMS argon sealed	X1171

Velp®

Velp® Part	Description	Part No
7713	Magnesium perchlorate granular 0.7 to 1.2 mm, H ₂ O absorbant 500 g	B1081
A00000148	Chromosorb W 30-60 mesh acid washed 10 g	B3015
A00000148	Chromosorb W 30-60 mesh acid washed 25 g	B3017
A00000153	Tin foil cones standard weight, pk of 100	D9001
A00000154	Silica (quartz) wool very fine 50 g	B1102
A00000155	Copper wires fine wires reduced 4 x 0.5 mm 500 g	B1176
A00000157	Copper oxide fine wires 4 x 0.5 mm 50 g	B1002
A00000157	Copper oxide wires fine wires 4 x 0.5 mm 250 g	B1122
A00000157	Copper oxide fine wires 4 x 0.5 mm 100 g	B1125
A00000225	EMADrone magnesium perchlorate 454 g	B1161
A00000235	Rice flour organic analytical standard 30 g	B2278
A00000236	Silicone grease 100 g	E2158
A00000240	Copper granules fine reduced 0.05 to 0.2 mm 100 g	B1108
A00000260	Tin foil squares standard weight 50 x 50 mm, pk of 500	D1118
A00000371	Silver squares 35 x 35 mm, pk of 100	D2084
A00000434	Sulfanilic acid OAS 5 g	B2147
A00000436	Tin capsules pressed standard weight 9 x 5 mm, pk of 250	D1021
A00000439	Tungstic oxide granular 0.85 to 1.7 mm 25 g	B1025
A00000440	Nickel carbon wool 5 g	B1242
A00000441	Silica (quartz) chips granular 0.85 to 1.7 mm 50 g	B1008
A00000447	Nickel wool fine wire 2 g	B1007

Products from Elemental Microanalysis

Operating from Devon, UK, our business holds three separate certifications and accreditations: ISO 9001 for our huge product range, supplying customers worldwide with high quality analytical consumables at value prices; ISO 17025 for our analytical services laboratory; and ISO 17034 for our new range of certified standards. Our qualified despatch and sales teams can organise safe, speedy and economical shipment of your orders worldwide by air, road or sea.

	SAMPLE ENCAPSULATION	GLASSWARE AND FURNACE TUBES	CHEMICAL REAGENTS	REFERENCE MATERIALS	OTHER PARTS AND CONSUMABLES
CHNOS (MICRO) ANALYSIS					
NITROGEN/PROTEIN DUMAS ANALYSIS					
INORGANIC ANALYSIS					
ORGANIC CARBON/SULFUR ANALYSIS					
MACRO CN/CHN/CNS ANALYSIS					
CF-IRMS ANALYSIS					
TRACE NITROGEN, SULFUR AND TOC ANALYSIS					

These pictures show only a small fraction of the thousands of products we have available for combustion elemental analysis. For further information please request our catalogue for the application area you are interested in. We can also provide Product Sheets giving a list of consumables specific to your analyser.



New from Elemental Microanalysis
ICP-MS cones
 compatible with:
 Thermo Fisher Scientific®
 Agilent Technologies®
 PerkinElmer®
 NU Instruments Ltd

Visit our website,
www.elementalmicroanalysis.com,
 for up-to-date information, product releases,
 news, and to subscribe to our mailing list.



Elemental Microanalysis Ltd.
1 Hameldown Road
Okehampton
Devon EX20 1UB
United Kingdom
Tel: +44 (0)1837 54446
Fax: +44 (0)1837 54544
Email: enquiries@microanalysis.co.uk

CRMs, Consumables & Spares: www.elementalmicroanalysis.com

Lab Analysis: www.elementallab.co.uk

